

»felo

2022





THE BEST TOOL
YOU HAVE.

WE UNDERSTAND.



№ 9



S. 6-8

ERGONIC®



S. 9-18

ERGONIC® ударные отвертки



S. 19-22

№ 9 VDE



S. 28-29

ERGONIC® VDE



S. 30-33

ERGONIC® VDE slim



S. 34-37

ERGONIC® K



S. 47-50

smart



S. 51-59

R-GO



S. 60-65

Динамометрические отвертки NM



S. 77-80

Стержни NM VDE



S. 81

Отвертки для точных работ



S. 82-85

Отвертки для точных работ ESD



S. 85

Отвертки с набором бит в рукоятке



S. 86-87

Т-образные отвертки



S. 88-90

Ключи флажковые



S. 91-92

Ключи шестигранные



S. 93-95

Битодержатели и адаптеры



S. 96-97

Битодержатель Star



S. 100

Битодержатель Impact



S. 99

Биты Industrial



S. 101-106

Биты Impact



S. 107-108

Биты Diamond



S. 108

Наборы бит



S. 119

Наборы бит Swift



S. 120

Наборы бит Pro Box



S. 121-122

Плоскогубцы



S. 123-127

Съемники стопорных колец



S. 129-130

Кабелерезы



S. 133

Наборы инструмента VDE



S. 138-143

Артикулы

S. 144-151

Серия 330

S. 23-25

Шило, расширитель

S. 26



S. 27

Отвертка

S. 6-27

Отвертки тестер сети

S. 38

E-smart VDE

S. 39-42

E-smart VDE slim

S. 43-46

VDE – Отвертка

S. 28-46

Наборы бит и головок XS

S. 66-76

Прочный кейс

S. 47-76

Крутящий момент-отвертка

S. 77-81

Отвертка для точных работ

S. 82-85

Отвертка с набором бит в рукоятке

S. 86-87

T-образная отвертка

S. 88-90

Ключ шестигранный

S. 91-95

Битодержатель

S. 96-100

Биты TiN

S. 109

Специальные биты и адаптеры

S. 110-115

Биты в блистере

S. 116-118

Биты

S. 100-118

Набор бит

S. 119-122

Пассатижи VDE

S. 132-135

Съемники изоляции

S. 136-137

Плоскогубцы

S. 123-137

Стенды и дисплеи

S. 138-143

Содержание

S. 144-151

THE felo-2K-SCREWDRIVER / SERIES 900

Felo - лидер по дизайну, эргономике, качеству стержней и технологии двухкомпонентной рукоятки. В двухкомпонентной отвертке серии 900 стержень проходит по всей длине рукоятки. Эргономичный дизайн рукоятки и противоскользящий материал (Soft Grip) помогает обеспечить наибольшую передачу усилия. Специальный дизайн двухкомпонентной рукоятки не позволяет инструменту скатываться с поверхности. Лезвия изготовлены из специальной хромомолибден-ванадиевой стали для достижения наилучшего результата при работе! Точная посадка в крепеж обеспечивается за счет черного наконечника (Black-Tip).

Nº9

Противоскользящий материал (Soft Grip) помогает обеспечить наибольшую передачу усилия

Стержень по всей длине рукоятки

Стержень рукоятки из хром-молибден-ванадиевой стали
Превосходный крутящий момент, который превышает стандарты DIN и ISO более чем на 100%

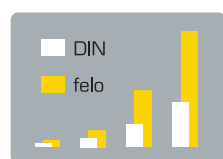

Специальный дизайн не позволяет инструменту скатываться с поверхности

Черный наконечник для точной посадки



EAN-Code на рукоятке



 VDE version
 AC 1000V /
 IEC 60900:2012

900



								Артикул		EAN - код
2,5 x 0,4 EI	75	80	28	2,5	12		900 022 10	30	40 07157 51481 3	
3,0 x 0,5 EI	80	80	28	3,0	12		900 032 10	30	40 07157 51483 7	
3,5 x 0,6 EI	100	80	28	3,5	12		900 353 10	35	40 07157 51485 1	
4,0 x 0,8 EI	100	90	31	4,0	12		900 043 10	50	40 07157 51487 5	
5,5 x 1,0	125	100	34	5,0	12		900 554 10	80	40 07157 51489 9	
6,5 x 1,2	150	100	34	6,0	12		900 655 10	95	40 07157 51491 2	
8,0 x 1,2	175	109	38	7,0	6		900 086 10	130	40 07157 51493 6	

901



PZ							Артикул		EAN - код
0	60	80	28	3,0	6		901 001 10	30	40 07157 64709 2
1	80	90	31	4,5	6		901 102 10	50	40 07157 51503 2
2	100	100	34	6,0	12		901 203 10	85	40 07157 51505 6
3	150	109	38	8,0	6		901 305 10	145	40 07157 51507 0

902



PH							Артикул		EAN - код
0	60	80	28	3,0	6		902 001 10	30	40 07157 51495 0
1	80	90	31	4,5	6		902 102 10	50	40 07157 51497 4
2	100	100	34	6,0	12		902 203 10	85	40 07157 51499 8
3	150	109	38	8,0	6		902 305 10	145	40 07157 51501 8

908



TORX [®]							Артикул		EAN - код
6	60	80	28	3,0	6		908 061 40	30	40 07157 64711 5
7	60	80	28	3,0	6		908 071 40	30	40 07157 64713 9
8	60	80	28	3,0	6		908 083 40	30	40 07157 64715 3
9	60	80	28	3,5	6		908 093 40	30	40 07157 64717 7
10	100	90	31	3,5	12		908 103 40	45	40 07157 64719 1
15	100	90	31	4,0	12		908 153 40	50	40 07157 64721 4
20	100	100	34	5,0	12		908 203 40	75	40 07157 64723 8
25	100	100	34	5,0	12		908 253 40	80	40 07157 64725 2
27	115	109	38	5,0	6		908 273 40	95	40 07157 64727 6
30	115	109	38	6,0	6		908 303 40	100	40 07157 64729 0

904



SQ						Артикул		EAN - код
1	120	90	31	94	6	904 100 10	55	40 07157 65091 7
2	160	100	34	106	12	904 200 10	90	40 07157 65093 1



	Артикул		EAN - код
(3 x) 900: 3,0 x 80 / 4,0 x 100 / 5,5 x 125	900 951 48	405	40 07157 64705 4
(2 x) 901: PZ 1 x 80 / PZ 2 x 100			
(3 x) 900: 3,0 x 80 / 4,0 x 100 / 5,5 x 125	900 952 48	405	40 07157 64707 8
(2 x) 902: PH 1 x 80 / PH 2 x 100			
(5 x) 908: Torx * 10 / Torx * 15 / Torx * 20 / Torx * 25 / Torx * 30	908 951 48	460	40 07157 64731 3
(3 x) 900: 3,0 x 80 / 4,0 x 100 / 5,5 x 125			
(1 x) 902: PH 2 x 100	900 953 48	460	40 07157 64731 3
(1 x) 904: SQ 2 x 160			

Ergonic, первая рукоятка, которая адаптируется к руке пользователя!



Гладкая, бесшовная ручка для максимального комфорта

Снижение утомляемости при работе благодаря амортизирующей трехкомпонентной рукоятке.

400
Серия

ERGONIC® (pat.)
EP 1963072

сильнее /
адаптируемый /
по-настоящему эргономичный

Шестигранная гайка под ключ для дополнительного усилия доступна в 410 серии

Дизайн рукоятки не позволяет инструменту скатываться с поверхности

Отверстие для удобного хранения или использования рычага

Стержни изготовлены из хром-молибден-ванадиевой стали

Символ типа наконечника стержня на конце рукоятки

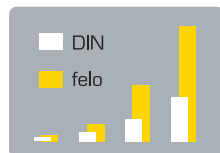

Превосходный крутящий момент, который превышает требования DIN и ISO на 100%

EAN- код на каждом товаре



Черный наконечник для точной посадки



Ударопрочный стержень по всей длине рукоятки



420



								Артикул		EAN - код
4,0 x 0,8	155	94	30	4,00	6			420 045 10	66	40 07157 50072 4
5,5 x 1,0	155	101	33	5,50	6			420 055 10	92	40 07157 50074 8

422



PH							Артикул		EAN - код
1	155	94	30	4,00	6		422 105 10	67	40 07157 50076 2
2	155	101	33	5,50	6		422 205 10	91	40 07157 50078 6

438



					Артикул		EAN - код
1/4"	100	101	33	6	438 125 40	102	40 07157 53711 9

НОВИНКИ

438



					Артикул		EAN - код
1/4"	15	106	36	6	438 126 40	76	40 07157 64849 5

438



					Артикул		EAN - код
1/4"	110	106	36	6	438 127 40	116	40 07157 64851 8

438

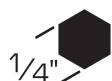

					Артикул		EAN - код
1/4"	25	106	36	6	438 128 90	85	40 07157 64853 2



400

							Артикул		EAN - код
2,5 x 0,4 EI	75	86	25	2,50	2	400 022 10	27	40 07157 53679 2	
3,0 x 0,5 EI	80	86	25	3,00	2	400 032 10	30	400 7157 53117 9	
3,5 x 0,6 EI	100	86	25	3,50	2	400 353 10	33	400 7157 53119 3	
4,0 x 0,8 EI	100	94	30	4,00	2	400 043 10	49	400 7157 53611 2	
4,0 x 0,8 EI	200	94	30	4,00	6	400 047 10	58	400 7157 50693 1	
4,0 x 0,8 EI	300	94	30	4,00	3	400 049 10	68	400 7157 51379 3	
5,0 x 0,8	150	101	33	5,00	2	400 055 10	75	400 7157 53619 8	
5,5 x 1,0	125	101	33	5,00	2	400 554 10	72	400 7157 53621 1	
5,5 x 1,0 EI	150	101	33	5,00	2	400 555 10	82	400 7157 53623 5	
5,5 x 1,0 EI	200	101	33	5,00	6	400 557 10	92	400 7157 53697 6	
5,5 x 1,0 EI	300	101	33	5,00	3	400 559 10	111	400 7157 50695 5	
6,0 x 1,2	100	106	36	6,00	2	400 063 10	79	400 7157 57589 0	
6,0 x 1,2	150	106	36	6,00	2	400 065 10	99	400 7157 57591 3	
6,0 x 1,2	200	106	36	6,00	2	400 067 10	112	400 7157 57593 7	
6,5 x 1,2	100	106	36	6,00	2	400 653 10	79	400 7157 53627 3	
6,5 x 1,2	150	106	36	6,00	2	400 655 10	102	400 7157 52799 8	
6,5 x 1,2	200	106	36	6,00	2	400 657 10	112	400 7157 53629 7	
6,5 x 1,2	500	106	36	6,00	3	400 610 10	190	400 7157 53699 0	
8,0 x 1,2	175	112	39	7,00	2	400 086 10	135	400 7157 52801 8	
8,0 x 1,2 EI	300	112	39	8,00	3	400 088 10	198	400 7157 51809 5	
10,0 x 1,6	200	112	39	8,00	6	400 107 10	162	400 7157 53681 5	

401

PZ						Артикул		EAN - код
0	60	86	25	3,00	6	401 001 10	30	40 07157 22100 1
1	80	94	30	4,50	2	401 102 10	50	40 07157 53683 9
2	100	106	36	6,00	2	401 203 10	92	40 07157 53685 3
2	300	106	36	6,00	3	401 209 10	125	40 07157 51769 2
3	150	112	39	8,00	6	401 305 10	148	40 07157 53687 7
4	150	112	39	10,00	6	411 405 40	228	40 07157 64355 1

402

PH						Артикул		EAN - код
0	60	86	25	3,00	6	402 001 10	30	40 07157 22106 3
1	80	94	30	4,50	2	402 102 10	50	40 07157 52803 2
1	200	94	30	4,50	3	402 107 10	65	40 07157 22111 7
2	100	106	36	6,00	2	402 203 10	92	40 07157 52805 6
2	150	106	36	6,00	2	402 205 10	103	40 07157 53637 2
2	200	106	36	6,00	6	402 207 10	114	40 07157 53639 6
2	300	106	36	6,00	3	402 209 10	123	40 07157 51381 6
2	500	106	36	6,00	3	402 210 10	187	40 07157 57813 6
3	150	112	39	8,00	6	402 305 10	146	40 07157 53689 1
4	150	112	39	10,00	6	412 405 40	228	40 0715763079 7



404

SQ						Артикул		EAN - код
0 (1,75 mm)	100	94	30	3,0	12	404 000 40	44	40 07157 60309 8
1 (2,30 mm)	120	94	30	4,5	12	404 100 40	56	40 07157 53507 8
2 (2,80 mm)	160	106	36	5,0	12	404 200 40	91	40 07157 53509 2
3 (3,30 mm)	160	106	36	6,0	12	404 300 40	105	40 07157 53511 5

408

Torx						Артикул		EAN - код
5	60	86	25	3,0	6	408 051 40	20	40 07157 22188 9
6	60	86	25	3,0	6	408 061 40	20	40 07157 22154 4
7	60	86	25	3,0	12	408 071 40	28	40 07157 52807 0
8	60	86	25	3,0	12	408 083 40	28	40 07157 52809 4
9	60	86	25	3,5	12	408 093 40	28	40 07157 52811 7
10	100	86	25	3,5	12	408 103 40	33	40 07157 52813 1
15	100	94	30	4,0	12	408 153 40	50	40 07157 52815 5
20	100	101	33	5,0	12	408 203 40	68	40 07157 52817 9
25	100	106	36	5,0	12	408 253 40	82	40 07157 52819 3
27	100	106	36	5,0	12	408 273 40	82	40 07157 52821 6
30	115	112	39	6,0	6	408 303 40	103	40 07157 52823 0
40	125	112	39	8,0	6	408 404 40	136	40 07157 52825 4
45	125	112	39	8,0	3	408 454 40	130	40 07157 22166 7

407

Torx TR						Артикул		EAN - код
10 H	100	86	25	3,50	12	407 103 40	33	40 07157 60903 8
15 H	100	94	30	4,00	12	407 153 40	50	40 07157 60905 2
20 H	100	101	33	5,00	12	407 203 40	68	40 07157 60907 6
25 H	100	106	36	5,00	12	407 253 40	82	40 07157 60909 0
27 H	100	106	36	5,00	6	407 273 40	70	40 07157 32242 5
30 H	115	112	39	6,00	6	407 303 40	98	40 07157 32244 9
40 H	125	112	39	8,00	6	407 404 40	130	40 07157 32246 3

409

Torx Plus						Артикул		EAN - код
6 IP	60	86	25	3,0	6	409 061 40	17	40 07157 51319 9
7 IP	60	86	25	3,0	6	409 071 40	28	40 07157 51321 2
8 IP	60	86	25	3,0	6	409 083 40	29	40 07157 51323 6
9 IP	60	86	25	3,0	6	409 093 40	30	40 07157 51325 0
10 IP	100	86	25	3,5	12	409 103 40	33	40 07157 51327 4
15 IP	100	94	30	4,0	12	409 153 40	48	40 07157 51329 8
20 IP	100	101	33	5,0	12	409 203 40	69	40 07157 51331 1
25 IP	100	106	36	5,0	12	409 253 40	69	40 07157 51333 5
27 IP	100	106	36	5,0	6	409 273 40	70	40 07157 51335 9
30 IP	115	112	39	6,0	6	409 303 40	97	40 07157 51337 3
40 IP	125	112	39	8,0	6	409 404 40	130	40 07157 51339 7



427



mm						Артикул		EAN - код
2	75	86	25	2,0	12	427 202 40	26	40 07157 22167 4
2,5	100	86	25	2,5	12	427 253 40	29	40 07157 22168 1
3	100	86	25	3,0	12	427 303 40	32	40 07157 22169 8
4	100	86	25	4,0	12	427 403 40	50	40 07157 22170 4
5	100	106	36	5,0	12	427 503 40	72	40 07157 22171 1
6	125	106	36	6,0	12	427 604 40	90	40 07157 22178 0
8	150	106	36	8,0	12	427 805 40	149	40 07157 22173 5

428



mm					Артикул		EAN - код
4	125	101	33	6	428 040 40	63	40 07157 22174 2
5	125	101	33	6	428 050 40	64	40 07157 22175 9
5,5	125	101	33	6	428 055 40	64	40 07157 22176 6
6	125	101	33	6	428 060 40	66	40 07157 22177 3
7	125	101	33	6	428 070 40	95	40 07157 22179 7
8	125	101	33	6	428 080 40	97	40 07157 22181 0
9	125	101	33	6	428 090 40	97	40 07157 22182 7
10	125	101	33	6	428 100 40	101	40 07157 22183 4
11	125	106	36	6	428 110 40	151	40 07157 22184 1
12	125	106	36	6	428 120 40	154	40 07157 22185 8
13	125	106	36	6	428 130 40	156	40 07157 22186 5
14	125	106	36	6	428 140 40	156	40 07157 22187 2

428



M-TEC

mm					Артикул		EAN - код
5,5	110	94	30	12	428 055 30	84	40 07157 60285 5
6	110	94	30	12	428 060 30	87	40 07157 60349 4
7	110	94	30	12	428 070 30	97	40 07157 60287 9
8	110	101	33	12	428 080 30	110	40 07157 60289 3
10	125	101	33	12	428 100 30	126	40 07157 60291 6
13	125	106	36	12	428 130 30	187	40 07157 60293 0

429



flexible

mm					Артикул		EAN - код
5	170	106	36	6	429 050 40	148	40 07157 60355 5
6	170	106	36	6	429 060 40	148	40 07157 60357 9
7	170	106	36	6	429 070 40	148	40 07157 60359 3
8	170	106	36	6	429 080 40	151	40 07157 60361 6
10	170	106	36	6	429 100 40	151	40 07157 60363 0

420

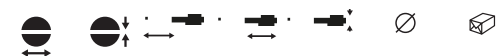

	155	94	30	4,00	6	Артикул	66	EAN - код
4,0 x 0,8						420 045 10		40 07157 50072 4
5,5 x 1,0		101	33	5,50	6	420 055 10	92	40 07157 50074 8

422



PH	155	94	30	4,00	6	Артикул	67	EAN - код
1						422 105 10		40 07157 50076 2
2		101	33	5,50	6	422 205 10	91	40 07157 50078 6

438



1/4"	100	101	33	6	Артикул	102	EAN - код
					438 125 40		40 07157 53711 9

НОВИНКИ

438



1/4"	15	106	36	6	Артикул	76	EAN - код
					438 126 40		40 07157 64849 5

438



1/4"	110	106	36	6	Артикул	116	EAN - код
					438 127 40		40 07157 64851 8

438



1/4"	25	106	36	6	Артикул	85	EAN - код
					438 128 90		40 07157 64853 2

НОВИНКИ

429



					Артикул		EAN - код
1/4"	170	106	36	6	429 735 40	156	40 07157 64847 1

429



					Артикул		EAN - код
1/4"	170	106	36	6	429 635 40	146	40 07157 60365 4

438



					Артикул		EAN - код
1/4"	100	106	36	6	438 100 40	102	40 07157 51397 7

497



					Артикул		EAN - код
MS 1/4"	100	101	33	6	497 110 40	107	40 07157 61479 7

497



Артикул



EAN - код

94

30

12

497 200 00

59

40 07157 62405 5

400



Артикул



EAN - код

400 917 43

2332

40 07157 60391 3

(5 x) 400: 3,0 x 80 / 4,0 x 100 / 5,5 x 125 / 6,5 x 150 / 8,0 x 175

(2 x) 401: PZ 1 x 80 / PZ 2 x 100

(2 x) 402: PH 1 x 80 / PH 2 x 100

(2 x) 413: 3,5 x 100 / 4,0 x 100



(2 x) 414: PH 1 x 80 / PH 2 x 100





(4 x) 408: Torx® 10 x 100 / Torx® 15 x 100 / Torx® 20 x 100 / Torx® 25 x 100

(1 x) Стальная стойка



400



	Артикул		EAN - код
Набор отверток 10 шт.	400 910 13	1296	40 07157 63633 1
(3 x) 400 :	4,0 x 100 / 5,5 x 125 / 6,5 x 150		
(2 x) 402:	PH 1 x 80 / PH 2 x 100		
(3 x) 408:	Torx* 15 / Тгх * 20 / Тгх * 25		
(1 x) 413:	3,5 x 100 		
(1 x) 361:	Отвертка - тестер напряжения сети VDE 0680 150V - 250V		
(1 x)	Стальная стойка		



	Артикул		EAN - код
Набор отверток 10 шт.	400 910 43	1296	40 07157 63635 5
(3 x) 400 :	4,0 x 100 / 5,5 x 125 / 6,5 x 150		
(2 x) 401:	PZ 1 x 80 / PZ 2 x 100		
(3 x) 408:	Torx* 15 / Тгх * 20 / Тгх * 25		
(2 x) 413:	3,5 x 100 		
(1 x) 361:	Отвертка - тестер напряжения сети VDE 0680 150V - 250V		
(1 x)	Стальная стойка		



400



	Артикул		EAN - код
Кейс с отвертками 7 шт.	400 106 36	682	40 07157 62409 3
(2 x) 400:	4,0 x 100 / 6,5 x 100		
(2 x) 401:	PZ 1 x 80 / PZ 2 x 100		
(2 x) 402:	PH 1 x 80 / PH 2 x 100		

400



	Артикул		EAN - код
Кейс с отвертками 6 шт.	400 206 36	652	40 07157 62411 6
(4 x) 400:	3,0 x 80 / 4,0 x 100 / 5,5 x 125 / 6,5 x 100		
(2 x) 402:	PH 1 x 80 / PH 2 x 100		



400



	Артикул		EAN - код
Набор отверток 7 шт.	400 971 18	602	40 07157 53695 2
(4 x) 400:	3,5 x 100 / 4,0 x 100 / 5,5 x 125 / 6,5 x 150		
(1 x) 401:	PZ 2 x 100		
(2 x) 402:	PH 1 x 80 / PH 2 x 100		

400

	Артикул		EAN - код
Набор отверток 6 шт.	400 961 18	548	40 07157 53691 4
(2 x) 400:	4,0 x 100 / 6,5 x 150		
(2 x) 401:	PZ 1 x 80 / PZ 2 x 100		
(2 x) 402:	PH 1 x 80 / PH 2 x 100		

400

	Артикул		EAN - код
Набор отверток 5 шт.	400 953 18	492	40 07157 57539 5
(3 x) 400:	4,0 x 100 / 5,5 x 125 / 6,5 x 150		
(2 x) 401:	PZ 1 x 80 / PZ 2 x 100		

400

	Артикул		EAN - код
Набор отверток 5 шт.	400 951 18	492	40 07157 53693 8
(3 x) 400:	4,0 x 100 / 5,5 x 125 / 6,5 x 150		
(2 x) 402:	PH 1 x 80 / PH 2 x 100		

400

	Артикул		EAN - код
Набор отверток 3 шт.	400 931 18	312	40 07157 53701 0
(2 x) 400:	5,5 x 125 / 6,5 x 150		
(1 x) 402:	PH 2 x 100		

404

	Артикул		EAN - код
Набор отверток 3 шт.	404 931 48	296	40 07157 53517 7
(3 x) 404:	SQ 1 / SQ 2 / SQ 3		

400

	Артикул		EAN - код
Набор отверток 3 шт.	400 931 14	368	40 07157 64947 8
(1 x) 400:	4,0 x 300		
(1 x) 401:	PZ 2 x 300		
(1 x) 402:	PH 2 x 300		



408



	Артикул		EAN - код
Набор отверток 3 шт.	408 931 48	186	40 07157 53171 1
(3 x) 408:	Torx 10 / Torx 15 / Torx 20		

408



	Артикул		EAN - код
Набор отверток 6 шт.	408 961 48	400	40 07157 53165 0
(6 x) 408:	Torx 8 / Torx 9 / Torx 10 / Torx 15 / Torx 20 / Torx 25		

408



	Артикул		EAN - код
Набор отверток 6 шт.	408 962 48	572	40 07157 63355 2
(6 x) 408:	Torx *10 / Torx *15 / Torx *20 / Torx *25 / Torx *30 / Torx *40		

407



	Артикул		EAN - код
Набор отверток 6 шт.	407 961 48	555	40 07157 64949 2
(6 x) 407:	Torx *TR 10 H / Torx *TR 15 H / Torx *TR 20 H / Torx *TR 25 H Torx *TR 30 H / Torx *TR 40 H		



M-TEC



M-Тес
428



	Артикул		EAN - код
Кейс с отвертками 6 шт.	428 106 36	952	40 07157 61373 8
(6 x) 428:	5,5 x 110 / 6,0 x 110 / 7,0 x 110 / 8,0 x 110 10,0 x 125 / 13,0 x 125		



Ударная рукоятка

Ergonic, первая рукоятка, которая адаптируется к руке пользователя!



Снижение утомляемости при работе благодаря амортизирующей трехкомпонентной рукоятке.

450 Серия

ERGONIC® (pat.)
EP 1963072

Серия 450 – уникальная отвертка с амортизирующей ударной рукояткой



Hexagon bolsters
Шестигранная гайка под ключ для дополнительного усилия

Дизайн рукоятки не позволяет инструменту скатываться с поверхности



код на

Стержни изготовлены из хром-молибден-ванадиевой стали

EAN-каждомговаре



4 007157 320940

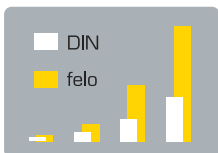

Превосходный крутящий момент, который превышает требования DIN и ISO на 100%

Улучшенный дизайн наконечника: острые края для лучшего сцепления и более высокого крутящего момента



Черный наконечник для точной посадки

Стержень по всей длине рукоятки

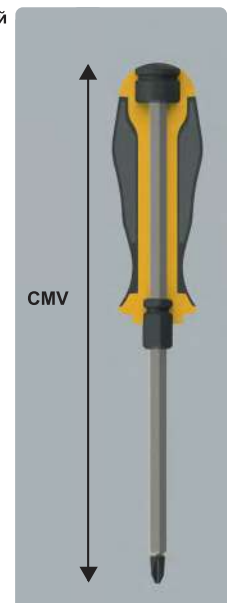

CMV



Существует множество эргономичных дизайнов рукояток, но всегда должна адаптироваться к рукоятке. ERGONIC - единственная рукоятка, адаптирующаяся под руку любого пользователя!

Первая по-настоящему эргономичная ударная отвертка со стержнем по всей длине рукоятки!

ERGONIC®

Лезвие расположено по всей длине идеальной эргономичной 3-компонентной рукоятки, которая состоит из жесткого пластика, мягкого компонента и противоскользящего покрытия.

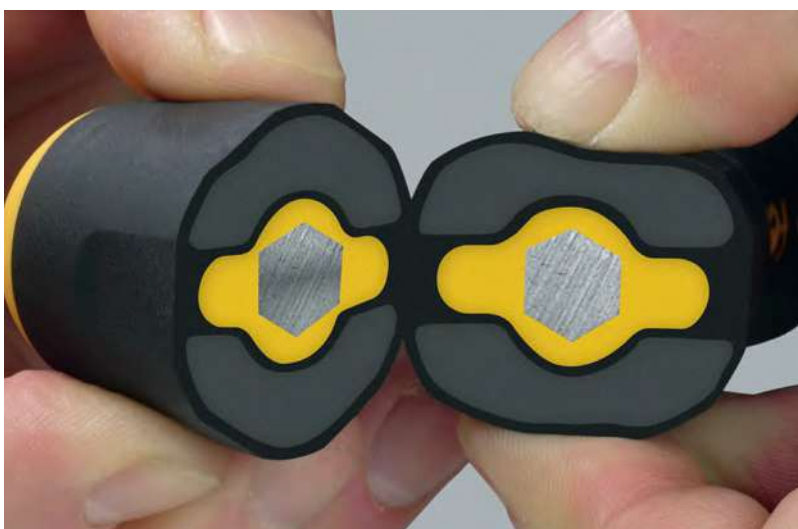

Стержень изготовлен из идеально закаленной стали и предназначен для мощных ударов, а вибрации при работе поглощаются рукояткой, защищая суставы.



felo
Innovations



450



Icon	Icon	Icon	Icon	Icon	Icon	Icon	Artikul	Icon	EAN - код
4,5 x 0,8	90	94	30	5,0	12		450 045 40	84	40 07157 64519 7
5,5 x 1,0	100	94	30	6,0	12		450 055 40	101	40 07157 64521 0
7,0 x 1,2	130	101	33	6,0	6		450 070 40	135	40 07157 64523 4
8,0 x 1,2	150	112	39	8,0	6		450 080 40	210	40 07157 64775 7
9,0 x 1,6	150	112	39	8,0	6		450 090 40	212	40 07157 64525 8
10,0 x 1,6	180	112	39	8,0	6		450 100 40	223	40 07157 64527 2
12,0 x 2,0	210	112	39	10,0	6		450 120 40	310	40 07157 64529 6

НОВИНКА

451



PZ	Icon	Icon	Icon	Icon	Icon	Artikul	Icon	EAN - код
1	80	94	30	5,0	12	451 102 40	82	40 07157 64787 0
2	100	101	33	6,0	6	451 203 40	122	40 07157 64789 4
3	150	112	39	8,0	6	451 305 40	201	40 07157 64791 7

452



PH	Icon	Icon	Icon	Icon	Icon	Artikul	Icon	EAN - код
1	80	94	30	5,0	12	452 102 40	82	40 07157 64531 9
2	100	101	33	6,0	6	452 203 40	122	40 07157 64533 3
3	150	112	39	8,0	6	452 305 40	201	40 07157 64535 7



450



SL/PH	Artikul	Icon	EAN - код
Набор отверток 5 шт.	450 952 48	640	40 07157 64537 1
(3 x) 450: 4,5 x 90 / 5,5 x 100 / 7,0 x 130			
(2 x) 452: PH 1 x 80 / PH 2 x 100			

450



SL/PH	Artikul	Icon	EAN - код
Набор отверток 5 шт.	450 951 48	880	40 07157 64835 8
(3 x) 450: 5,5 x 100 / 7,0 x 130 / 8,0 x 150			
(2 x) 452: PH 2 x 100 / PH 3 x 150			



НОВИНКИ

450



SL/PZ	Артикул		EAN - код
Набор отверток 5 шт.	450 953 48	640	4007157649553
(3 x) 450: 4,5 x 90 / 5,5 x 100 / 7,0 x 130			
(2 x) 451: PZ 1 x 80 / PZ 2 x 100			



M-TEC









500



       	Артикул		EAN - код
3,0 x 0,5 80 80 25 3,0 6	500 032 30	30	40 07157 51681 7
3,0 x 0,5 200 80 25 3,0 6	500 037 30	36	40 07157 51981 8
3,5 x 0,6 100 80 25 3,5 6	500 353 30	34	40 07157 51683 1
3,5 x 0,6 250 80 25 3,5 6	500 358 30	46	40 07157 51983 2
4,0 x 0,8 100 90 29 4,0 6	500 043 30	50	40 07157 51685 5
4,0 x 0,8 200 90 29 4,0 6	500 047 30	60	40 07157 51757 9

501



PZ     	Артикул		EAN - код
1 80 90 29 4,5 6	501 102 30	52	40 07157 51677 0
2 100 99 34 6,0 6	501 203 30	84	40 07157 51679 4
2 200 99 34 6,0 6	501 207 30	108	

502



PH     	Артикул		EAN - код
1 80 90 29 4,5 6	502 102 30	50	40 07157 51673 2
1 200 90 29 4,5 6	502 107 30	68	40 07157 51985 6
2 100 99 34 6,0 6	502 203 30	84	40 07157 51675 6
2 200 99 34 6,0 6	502 207 30	106	40 07157 51761 6

508



TORX [®]     	Артикул		EAN - код
10 100 80 25 3,5 6	508 103 30	34	40 07157 51665 7
15 100 90 29 4,0 6	508 153 30	50	40 07157 51667 1
20 100 99 34 5,0 6	508 203 30	72	40 07157 51669 5
25 100 99 34 5,0 6	508 253 30	73	40 07157 51671 8



Кожаное покрытие для защиты от сколов

Стержень по всей длине рукоятки

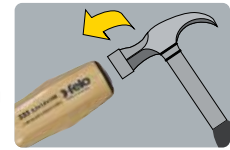

Эргономичная ручка

Рукоятка из твердого бука

330 Серия

Наша цель - качественные, традиционные ручные инструменты

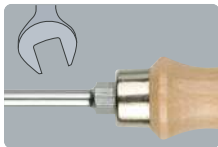

Кованная гайка под ключ

Дизайн рукоятки не позволяет инструменту скатываться с поверхности

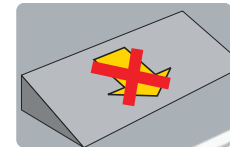

Ножи изготовлены из хром-молибден-ванадиевой стали



Стержень по всей длине рукоятки

Превосходный крутящий момент, который превышает требования DIN и ISO на 100 %

EAN- код на каждом товаре



Хромированное лезвие с черным наконечником

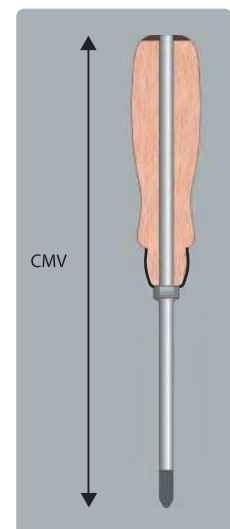



335



Размер	Длина	Ширина	Высота	Диаметр	Объем	Артикул	Код	EAN - код
3,5 x 0,6	75	95	24	4,5	12	335 035 90	47	40 07157 18031 5
4,5 x 0,8	90	95	24	4,5	12	335 045 90	55	40 07157 18032 2
5,5 x 1,0	100	100	26	5,5	12	335 055 90	72	40 07157 18036 0
7,0 x 1,2	125	110	30	6,0	12	335 065 90	113	40 07157 18040 7
9,0 x 1,2	150	120	32	8,0	12	335 080 90	160	40 07157 18043 8
10,0 x 1,6	175	125	34	9,0	6	335 100 90	184	40 07157 18047 6
12,0 x 2,0	200	125	34	9,0	6	335 120 90	232	40 07157 18050 6

336



PZ	Длина	Ширина	Высота	Диаметр	Объем	Артикул	Код	EAN - код
1	80	95	24	4,5	12	336 102 90	47	40 07157 18060 5
2	100	110	30	6,0	12	336 203 90	88	40 07157 18061 2
3	150	120	32	8,0	6	336 305 90	163	40 07157 18062 9

337



PH	Длина	Ширина	Высота	Диаметр	Объем	Артикул	Код	EAN - код
1	80	95	24	4,5	12	337 102 90	45	40 07157 18063 6
2	100	110	30	6,0	12	337 203 90	88	40 07157 18067 4
3	150	120	32	8,0	6	337 305 90	164	40 07157 18071 1



335



Артикул	Код	EAN - код
Набор отверток 5 шт.	335 951 98	592 40 07157 22155 1
(3 x) 335:	5,5 x 100 / 7,0 x 125 / 9,0 x 150	
(2 x) 337:	PH 1 x 80 / PH 2 x 100	

335



Артикул	Код	EAN - код
Набор отверток 5 шт.	335 952 98	592 40 07157 30762 0
(3 x) 335:	5,5 x 100 / 7,0 x 125 / 9,0 x 150	
(2 x) 336:	PZ 1 x 80 / PZ 2 x 100	

335



Артикул	Код	EAN - код
Набор отверток 7 шт.	335 971 98	714 40 07157 18108 4
(4 x) 335:	4,5 x 90 / 5,5 x 100 / 7,0 x 125 / 9,0 x 150	
(1 x) 336:	PZ 2 x 100	
(2 x) 337:	PH 1 x 80 / PH 2 x 100	



057



	Артикул		EAN - код
Набор в кейсе 18 шт.	057 718 66	513	40 07157 62367 6
(1 x) Мини трещетка 1/4"			
(7 x) Головки / 5 mm / 5,5 mm / 6 mm / 7 mm / 8 mm / 10 mm / 13 mm			
(7 x) Биты (С6,3 x 25 mm) 4,0 x 0,8 / 5,5 x 1,0 / 6,5 x 1,2 / PZ 2 / PH 1 / PH 2 / PH 3			
(1 x) Удлинитель (50 mm) 1/4м - 1/4м			
(1 x) Переходник С 6,3 - 1/4м (25 mm)			
(1 x) Держатель бит Е 6,3 x 58 mm			
Деревянный кейс 160 mm x 82 mm x 34 mm			

490



←	→	+	∅	⊠	Артикул		EAN - код
60	60	32	4,0	12	490 041 10	36	40 07157 31078 1

493



←	→	+	∅	⊠	Артикул		EAN - код
100	80	34	6,0	12	493 063 10	72	40 07157 23006 5

498



←	→	+	∅	⊠	Артикул		EAN - код
100	80	34	6,0	12	498 063 10	73	40 07157 23013 3

494



←	→	+	∅	⊠	Артикул		EAN - код
100	80	34		12	494 003 30	75	40 07157 24022 4

НОВИНКА

494



←	→	+	∅	⊠	Артикул		EAN - код
125	106	36	7,00	6	494 125 30	145	40 07157 64957 7
310	106	36	7,00	6	494 310 30	195	40 07157 64959 1

Stubby



							Артикул		EAN - код
3,5 x 0,6	25	61	25	3,50	6		460 035 10	30	40 07157 64845 7
5,5 x 1,0 EI	25	61	25	5,00	6		460 055 10	31	40 07157 61509 1
6,5 x 1,2 EI	25	61	25	6,00	6		460 065 10	31	40 07157 64855 6
PZ 1	25	61	25	4,50	6		461 010 10	31	40 07157 64857 0
PZ 2	25	61	25	6,00	6		461 020 10	33	40 07157 64859 4
PH 1	25	61	25	4,50	6		462 010 10	31	40 07157 64861 7
PH 2	25	61	25	6,00	6		462 020 10	33	40 07157 61511 4
T 15	25	61	25	4,00	6		468 150 10	31	40 07157 64863 1
T 20	25	61	25	5,00	6		468 200 10	33	40 07157 64865 5
T 25	25	61	25	5,00	6		468 250 10	33	40 07157 64867 9

Stubby



					Артикул		EAN - код
1/4"	18	61	25	6	469 026 40	38	40 07157 61727 9

469



				Артикул		EAN - код
1/4"	61	25	6	469 025 40	32	40 07157 61585 5

469



					Артикул		EAN - код
PH 2 x 60	61	25	6	469 260 10	56	40 07157 31068 2	
SL 5,5							

THE felo-2K-SCREWDRIVER / SERIES 900

Felo - лидер по дизайну, эргономике, качеству стержней и технологии двухкомпонентной рукоятки. В двухкомпонентной отвертке серии 900 стержень проходит по всей длине рукоятки. Эргономичный дизайн рукоятки и противоскользящий материал (Soft Grip) помогает обеспечить наибольшую передачу усилия. Специальный дизайн двухкомпонентной рукоятки не позволяет инструменту скатываться с поверхности. Лезвия изготовлены из специальной хромомолибден-ванадиевой стали для достижения наилучшего результата при работе! Точная посадка в крепеж обеспечивается за счет черного наконечника (Black-Tip).

N°9 VDE

Эргономичный изысканный дизайн



Стержень рукоятки из хром-молибден-ванадиевой стали
Превосходный крутящий момент, который превышает стандарты DIN и ISO более чем на 100%

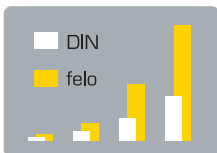

Каждая отвертка индивидуально протестирована на напряжение 10.000 Вольт

Специальный дизайн не позволяет инструменту скатываться с поверхности



Код EAN на каждом продукте





913



							Артикул		EAN - код
2,5 x 0,4	75	80	28	2,5	12		913 025 90	30	40 07157 64733 7
3,0 x 0,5	100	80	28	3,0	12		913 030 90	30	40 07157 64735 1
3,5 x 0,8	100	80	28	3,5	12		913 035 90	32	40 08157 65095 5
4,0 x 0,8	100	90	31	3,5	12		913 040 90	45	40 07157 64737 5
5,5 x 1,0	125	100	34	4,5	12		913 055 90	75	40 07157 64739 9
6,5 x 1,2	150	100	34	5,5	12		913 065 90	95	40 07157 64743 6

914



PH						Артикул		EAN - код
0	60	80	28	3,0	6	914 001 90	30	40 07157 64745 0
1	80	90	31	4,5	6	914 102 90	50	40 07157 64747 4
2	100	100	34	6,0	12	914 203 90	90	40 07157 64749 8
3	150	109	38	8,0	6	914 304 90	145	40 07157 64751 1

915



PZ						Артикул		EAN - код
0	60	80	28	3,0	6	915 001 90	30	40 07157 64753 5
1	80	90	31	4,5	6	915 102 90	50	40 07157 64755 9
2	100	100	34	6,0	12	915 203 90	90	40 07157 64757 3
3	150	109	38	8,0	6	915 304 90	150	40 07157 64759 7

919



SQ						Артикул		EAN - код
1	100	90	31	3,5	6	919 100 90	46	40 07157 65099 3
2	100	100	34	6,0	12	919 200 90	93	40 07157 65101 3



913



	Артикул		EAN - код
	913 961 98	440	40 07157 64673 6
(3 x) 913	2,5 x 75 / 4,0 x 100 / 5,5 X 125		
(2 x) 914	PH 1 x 80 / PH 2 x 100		
(1 x) 361	VDE Отвертка - тестер напряжения сети VDE 0680/6, 220-250 Volt		
	913 962 98	946	40 07157 65105 1
(3 x) 913	3,5 x 100 / 4,0 x 100 / 5,5 x 125		
(1 x) 914	PH 2 x 100		
(2 x) 919	SQ 1 x 100 / SQ 2 x 100		

Ergonic, первая рукоятка, которая адаптируется к руке пользователя!



Гладкая, бесшовная ручка для максимального комфорта

Снижение утомляемости при работе благодаря амортизирующей трехкомпонентной рукоятке.

VDE Серия 400 **ERGONIC**® (pat.)

AC 1000V
IEC 60900



Стержни изготовлены из хром-молибден-ванадиевой стали

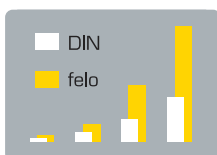

Превосходный крутящий момент, который превышает требования DIN и ISO на 100%

EAN- код на каждом товаре



Черный наконечник для точной посадки

Сильнее /
адаптируемый /
по-настоящему эргономичный

Отверстие для удобного хранения или использования рычага

Дизайн рукоятки не позволяет инструменту скатываться с поверхности

Символ типа наконечника стержня на конце рукоятки



Ударопрочный стержень по всей длине рукоятки





413



						Артикул		EAN - код
2,5 x 0,4	75	86	25	2,5	12	413 025 90	28	40 07157 53133 9
3,0 x 0,5	100	86	25	3,0	12	413 030 90	32	40 07157 53135 3
3,5 x 0,6	100	86	25	3,5	12	413 035 90	34	40 07157 53139 1
3,5 x 0,8	100	86	25	3,5	12	413 038 90	34	40 07157 61731 6
4,0 x 0,8	100	94	30	3,5	12	413 040 90	46	40 07157 53141 4
4,5 x 1,0	125	101	33	4,5	12	413 045 90	69	40 07157 53143 8
5,5 x 1,0	125	101	33	4,5	12	413 055 90	68	40 07157 53145 2
6,5 x 1,2	150	106	36	5,5	6	413 065 90	100	40 07157 53147 6
8,0 x 1,2	175	112	39	7,0	6	413 080 90	140	40 07157 53149 0

414



PH						Артикул		EAN - код
0	60	86	25	3,0	12	414 001 90	29	40 07157 53151 3
1	80	94	30	5,0	12	414 102 90	51	40 07157 53153 7
2	100	106	36	6,0	12	414 203 90	94	40 07157 53155 1
3	150	112	39	8,0	6	414 304 90	150	40 07157 53157 5

415



PZ						Артикул		EAN - код
1	80	94	30	5,0	12	415 102 90	51	40 07157 53159 9
2	100	106	36	6,0	12	415 203 90	94	40 07157 53161 2
3	150	112	39	8,0	6	415 304 90	151	40 07157 53163 6

416



Plus/Minus						Артикул		EAN - код
H1	80	94	30	5,0	12	416 102 90	51	40 07157 60311 1
H2	100	106	36	6,0	12	416 203 90	94	40 07157 60313 5

417



Plus/Minus						Артикул		EAN - код
Z1	80	94	30	5,0	12	417 102 90	51	40 07157 60315 9
Z2	100	106	36	6,0	12	417 203 90	94	40 07157 60317 3

418



Torx ^Æ						Артикул		EAN - код
10	100	86	25	3,5	12	418 103 90	37	40 07157 60369 2
15	100	94	30	3,5	12	418 153 90	54	40 07157 60371 5
20	125	101	33	4,5	12	418 203 90	76	40 07157 60373 9
25	125	106	36	4,5	12	418 253 90	84	40 07157 60375 3
30	150	112	39	6,0	6	418 303 90	118	40 07157 60377 7

419



SQ						Артикул		EAN - код
1 (1,75 mm)	100	94	30	3,5	12	419 100 90	47	40 07157 57343 8
2 (2,30 mm)	100	106	36	6,0	12	419 200 90	94	40 07157 57345 2



417



	Артикул		EAN - код
Набор в блистере 2 шт.	417 921 91	290	40 07157 63697 3
(2x) 417: Z1 / Z2			



413



	Артикул		EAN - код
(2 x) 413: 4,0 x 100 / 5,5 x 125	413 931 94	254	40 07157 53175 9
(1 x) 414: PH 2 x 100			

413



	Артикул		EAN - код
(4 x) 413: 3,0 x 100 / 4,0 x 100 / 5,5 x 125 / 6,5 x 150	413 961 98	506	40 07157 53169 8
(2 x) 414: PH 1 x 80 / PH 2 x 100			

413



	Артикул		EAN - код
Набор отверток 6 шт.	413 963 98	413	40 07157 61081 2
(3 x) 413: 2,5 x 75 / 4,0 x 100 / 5,5 x 125			
(2 x) 414: PH 1 x 80 / PH 2 x 100			
(1 x) 361: VDE Отвертка - тестер напряжения сети VDE 0680/6, 220-250 Volt			



413



	Артикул		EAN - код
Набор отверток 10 шт.	414 910 93	1224	40 07157 63631 7
(4 x) 413: 2,5 x 75 / 3,5 x 100 / 4,0 x 100 / 5,5 x 125			
(3 x) 414: PH 0 x 60 / PH 1 x 80 / PH 2 x 100			
(1 x) 415: PZ 2 x 100			
(2 x) 418: Torx [®] 10 x 100 / Torx [®] 20 x 125			
(1 x) Стальная стойка			

M-TEC



419



MТec					Артикул		ЕАN - код
5,5	110	94	30	12	419 055 30	103	40 07157 60297 8
6	110	94	30	12	419 060 30	104	40 07157 60351 7
7	110	94	30	12	419 070 30	114	40 07157 60299 2
8	110	101	33	12	419 080 30	133	40 07157 60301 2
10	125	101	33	12	419 100 30	140	40 07157 60303 6
13	125	106	36	12	419 130 30	237	40 07157 60305 0



419



	Артикул		ЕАN - код
Кейс с отвертками 6 шт. М-Тec	419 106 36	980	40 07157 61371 4
(6 x) 419:	5,5 x 110 / 6,0 x 110 / 7,0 x 110 / 8,0 x 110 10,0 x 125 / 13,0 x 125		

Отверстие для удобного хранения
или использования рычага



Символ типа наконечника
стержня на конце рукоятки



Ручка
на 30%
тоньше!



Удлиненная
ручка

Ergonic (pat.)
U.S. Patent No 7,877,843
Eslim

Ergonic - единственная
ручка, которая адаптируется
к руке пользователя!



Дизайн рукоятки не позволяет
инструменту скатываться с
поверхности

AC 1000V
IEC 60900



Лезвия изготовлены из хром-
молибден-ванадиевой стали



Изоляция
на 50%
тоньше!

Черный наконечник для
точной посадки



Ручка E-Slim — уникальной формы на 30% тоньше и на 20% длиннее и идеально подходит для максимального баланса приложения регулируемого крутящего момента, доступности и безопасного расстояния в труднодоступных рабочих местах.

Разработаны при сотрудничестве с электриками

Все отвертки сертифицированы в соответствии с DIN EN 60900, требующего, чтобы каждый отдельный стержень был испытан при 10000 Вольт, чтобы гарантировать безопасность при работе до 1000 Вольт.



Отвертки E-Slim были разработаны при сотрудничестве с электриками для удовлетворения их требований в работе. Изоляция E-Slim на 50% тоньше, чем на обычных отвертках VDE, благодаря чему стало удобнее работать с винтами с потайной головкой.





413



							Артикул		EAN - код
3,0 x 0,5	100	105	25	3,5	12		413 930 90	45	40 07157 62631 8
3,5 x 0,6	100	105	25	3,5	12		413 935 90	45	40 07157 62635 6
3,5 x 0,8	100	105	25	3,5	12		413 938 90	45	40 07157 62637 0
4,0 x 0,8	100	105	25	4,0	12		413 940 90	46	40 07157 62639 4
4,5 x 1,0	125	115	27	4,5	12		413 945 90	62	40 07157 62641 7
5,5 x 1,0	125	115	27	5,5	12		413 955 90	73	40 07157 62643 1
6,5 x 1,2	125	115	27	6,5	12		413 965 90	86	40 07157 62645 5

414



PH						Артикул		EAN - код
1	80	105	25	4,5	12	414 192 90	45	40 07157 62647 9
2	100	115	27	6,0	12	414 293 90	73	40 07157 62649 3

415



PZ						Артикул		EAN - код
1	80	105	25	4,5	12	415 192 90	44	40 07157 62651 6
2	100	115	27	6,0	12	415 293 90	73	40 07157 62653 0

416



PlusMinus						Артикул		EAN - код
H 1	80	105	25	4,5	12	416 192 90	45	40 07157 62655 4
H 2	100	115	27	6,0	12	416 293 90	73	40 07157 62657 8

417



PlusMinus						Артикул		EAN - код
Z 1	80	105	25	4,5	12	417 192 90	45	40 07157 62659 2
Z 2	100	115	27	6,0	12	417 293 90	73	40 07157 62661 5

418



Torx ^{AE}						Артикул		EAN - код
10	100	105	25	3,5	12	418 109 90	46	40 07157 62663 9
15	100	105	25	3,5	12	418 159 90	46	40 07157 62665 3
20	125	115	27	4,5	12	418 209 90	62	40 07157 62667 7
25	125	115	27	4,5	12	418 259 90	63	40 07157 62669 1

419



SQ						Артикул		EAN - код
1 (1,75 mm)	100	105	25	4,5	12	419 190 90	46	40 07157 63167 1
2 (2,30 mm)	125	115	27	4,5	12	419 290 90	62	40 07157 63169 5

417



	Артикул		EAN - код
Набор отверток 4 шт.	417 841 98	321	40 07157 64951 5
(2 x) 413:	3,5 x 100 / 5,5 x 125		
(2 x) 417:	Z1 x 80 / Z2 x 100		



413



	Артикул		EAN - код
Набор отверток 5 шт.	413 851 98	371	40 07157 62743 8
(3 x) 413:	3,0 x 100 / 4,0 x 100 / 5,5 x 125		
(2 x) 414:	PH 1 x 80 / PH 2 x 100		

413



	Артикул		EAN - код
Набор отверток 5 шт.	413 853 98	371	40 07157 63325 5
(3 x) 413:	3,0 x 100 / 4,0 x 100 / 5,5 x 125		
(2 x) 415:	PZ 1 x 80 / PZ 2 x 100		

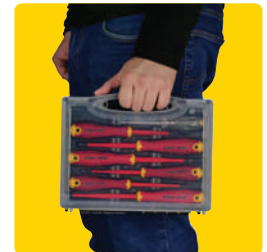

413



	Артикул		EAN - код
Кейс с отвертками 7 шт.	413 807 36	650	40 07157 62745 2
(3 x) 413:	3,0 x 100 / 4,0 x 100 / 5,5 x 125		
(2 x) 414:	PH 1 x 80 / PH 2 x 100		
(1 x) 415:	PZ 2 x 100		
(1 x) 361:	VDE Отвертка- тестер напряжения сети VDE 0680/6, 220-250 Volt		

418



	Артикул		EAN - код
Набор отверток 4 шт.	418 841 98	321	40 07157 64953 9
(4 x) 418:	Torx ^R 10 / Torx ^R 15 / Torx ^R 20 / Torx ^R 25		

413



	Артикул		EAN - код
Набор отверток 10 шт.	413 910 93	1212	40 07157 63627 0
(4 x) 413:	3,0 x 100 / 3,5 x 100 / 4,0 x 100 / 5,5 x 125		
(2 x) 414:	PH 1 x 80 / PH 2 x 100		
(1 x) 415:	PZ 2 x 100		
(2 x) 418:	Torx ^R 15 x 100 / Torx ^R 20 x 125		
(1 x) 361:	VDE Отвертка - тестер напряжения сети VDE 0680 150V - 250V		
(1 x)	Стальная стойка		

VDE Отвертка- тестер напряжения сети

361



VDE 0680-6

					Артикул		EAN - код
				12	361 300 00	17	40 07157 26509 8
3,0 x 0,8	65	77	13				
dto. в блистере					361 300 01	27	40 07157 26510 4

361



VDE 0680-6

					Артикул		EAN - код
				12	361 350 00	30	40 07157 26512 8
3,5 x 1,0	100	87	17				
dto. в блистере					361 350 01	43	40 07157 26513 5

361



VDE 0680-6

					Артикул		EAN - код
				12	361 400 00	30	40 07157 52701 11
3,0 x 0,8	70	75	23				

361



VDE 0680-6

					Артикул		EAN - код
				12	361 400 01	43	40 07157 53229 9
3,0 x 0,8	70	75	23				

Отвертка с 12-ю сменными стержнями по стандарту IEC с 2-компонентной ручкой в прочном кейсе.

Каждая отвертка проверена на напряжение до 10.000 В, полностью соответствует DIN ISO 60900: 2004

AC 1000V
IEC 60900



Надежное крепление стержней, механизм быстрого отсоединения на рукоятке от случайного извлечения



Esmart (pat.)





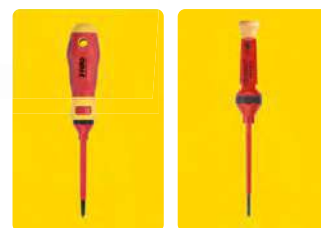

1000 V
 IEC 60900:2018



063



	Артикул		ЕАН - код
Кейс, 14 шт.	063 913 06	984	40 07157 51719 7
(12 x) Стержень			
	2,5 x 0,4 / 3,0 x 0,5 / 3,5 x 0,6 / 4,0 x 0,8 / 5,5 x 1,0 / 6,5 x 1,2		
	PZ 2		
	PH 1 / PH 2		
	Torx [®] 10 / Torx [®] 15 / Torx [®] 20		
	Рукоятка 95 x 32 mm		
	Прецизионный колпачок		
	Прочный кейс 230 x 130 x 56 mm		

063



DVE GS
1000 V
 IEC 60900:2018



	Артикул		EAN - код
Кейс, 14 шт.	063 913 16	1071	40 07157 53263 3
(10 x) Стержень			
2,5 x 0,4 / 3,0 x 0,5 / 3,5 x 0,6 / 4,0 x 0,8 / 5,5 x 1,0 / 6,5 x 1,2			
PZ 2			
PH 1 / PH 2			
Z2			
Bit: Spanner 10 x 25			
Универсальный ключ для ящиков			
Рукоятка 95 x 32 mm			
Прецизионный колпачок			
Прочный кейс 230 x 130 x 56 mm			

063



DVE GS
1000 V
 IEC 60900:2018

	Артикул		EAN - код
Сумка, 19 шт.	063 919 04	1550	40 07157 60353 1
(14 x) Стержень			
2,5 x 0,4 / 3,0 x 0,5 / 3,5 x 0,6 / 4,0 x 0,8 / 5,5 x 1,0 / 6,5 x 1,2			
PZ 2			
PH 1 / PH 2			
Torx® 10 / Torx® 15 / Torx® 20			
H 2			
Z 2			
Рукоятка 95 x 32 mm			
Прецизионный колпачок			
Плоскогубцы VDE 180 mm			
Бокорезы VDE 160 mm			
VDE Отвертка- тестер напряжения сети 3,0 mm x 70 mm			
Сумка 310 x 190 x 70 mm			

063



Артикул



EAN - код

063 105 00

42

40 07157 51749 4

063



Артикул



EAN - код

2,5 x 0,4 75 mm

1

063 025 04

30

40 07157 51721 0

3,0 x 0,5 100 mm

1

063 030 04

34

40 07157 51723 4

3,5 x 0,6 100 mm

1

063 035 04

37

40 07157 51725 8

4,0 x 0,8 100 mm

1

063 040 04

37

40 07157 51727 2

5,5 x 1,0 100 mm

1

063 055 04

45

40 07157 51729 6

6,5 x 1,2 100 mm

1

063 065 04

53

40 07157 51731 9

PH 1 80 mm

1

063 102 04

48

40 07157 51733 3

PH 2 100 mm

1

063 203 04

57

40 07157 51735 7

PZ 1 80 mm

1

063 102 14

41

40 07157 51737 1

PZ 2 100 mm

1

063 203 14

57

40 07157 51739 5

Torx® 8 100 mm

1

063 083 04

35

40 07157 51741 8

Torx® 10 100 mm

1

063 103 04

37

40 07157 51743 2

Torx® 15 100 mm

1

063 153 04

37

40 07157 51745 6

Torx® 20 100 mm

1

063 203 24

41

40 07157 51747 0

H 1 80 mm

1

063 112 04

48

40 07157 51887 3

H 2 100 mm

1

063 223 04

57

40 07157 51889 7

Z 1 80 mm

1

063 112 14

41

40 07157 51891 0

Z 2 100 mm

1

063 223 14

57

40 07157 51893 4

SQ0 (1,75 mm) 100 mm

1

063 000 04

34

40 07157 53089 9

SQ1 (2,30 mm) 100 mm

1

063 100 04

37

40 07157 53091 2

SQ2 (2,80 mm) 100 mm

1

063 200 04

57

40 07157 53093 6

SQ3 (3,30 mm) 100 mm

1

063 300 04

57

40 07157 53095 0

063



- (1 x) Spanner 10
- (3 x) 5 mm, 6, 7
- (1 x) 9 mm
- (1 x) 3 - 5 mm
- (1 x) 1/4"



Артикул



EAN - код

063 999 01

157

40 07157 62417 8

10 сменных стержней с 2-компонентной рукояткой в прочном StrongBox или сумке на ремне

Надежная фиксация стержней. Кнопка быстрого извлечения стержней на рукоятке защищает от нежелательного выпадения

Esmart slim (pat.)



Изоляция на 50% тоньше!





10 сменных лезвий можно легко комбинировать с двухкомпонентной рукояткой. Автоматическая блокировка удерживает лезвие в рукоятке и предотвращает случайное вытягивание. Для большей безопасности!

Первый компактный умный инструмент для электриков в тонком исполнении

Изоляция, уменьшенная на 50%, позволяет легко добраться до винтовых и пружинных элементов с глубокой посадкой. Все отвертки проходят индивидуальные испытания при напряжении 10 000 вольт.



С помощью закрепленной головки и 12 сменных стержней отвертку можно использовать в качестве инструмента для точных работ с особо чувствительным устройством.





063



1000 V
 IEC 60900:2018

	Артикул		EAN - код
	063 812 04	450	40 07157 64465 7
(10 x) Стержни	2,5 x 0,4 / 3,0 x 0,5 / 4,0 x 0,8 / 5,5 x 1,0		
	PZ 2		
	PH 1 / PH 2		
	Torx® 10 / Torx® 15 / Torx® 20		
	Рукоятка 102 x 32 mm		
	Прецизионный колпачок		
	Поясная сумка		

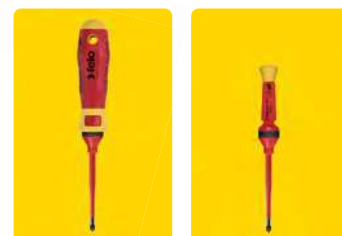

063





1000 V
 IEC 60900:2018

	Артикул		EAN - код
	063 812 06	695	40 07157 64467 1
(10 x) Стержни	2,5 x 0,4 / 3,0 x 0,5 / 4,0 x 0,8 / 5,5 x 1,0		
	PZ 2		
	PH 1 / PH 2		
	Torx® 10 / Torx® 15 / Torx® 20		
	Рукоятка 102 x 32 mm		
	Прецизионный колпачок		
	Прочный кейс 230 x 130 x 56 mm		

063



Артикул		EAN - код
063 205 00	46	40 07157 64511 1









Изоляция на
50% тоньше



1000 V
IEC 60900:2018

063



		Артикул		EAN - код
2,5 x 0,4 75 mm	1	063 025 94	30	40 07157 51721 0
3,0 x 0,5 100 mm	1	063 030 94	34	4007157 64473 2
3,5 x 0,6 100 mm	1	063 035 94	37	4007157 64475 6
4,0 x 0,8 100 mm	1	063 040 94	37	4007157 64477 0
5,5 x 1,0 100 mm	1	063 055 94	45	4007157 64469 5
6,5 x 1,2 100 mm	1	063 065 94	53	4007157 64471 8
 PH 1 80 mm	1	063 102 94	48	40 07157 64479 4
PH 2 100 mm	1	063 203 94	57	40 07157 64481 7
 PZ 1 80 mm	1	063 102 95	41	40 07157 64483 1
PZ 2 100 mm	1	063 203 95	57	40 07157 64485 5
 Torx® 10 100 mm	1	063 103 94	37	40 07157 64497 8
Torx® 15 100 mm	1	063 153 94	37	40 07157 64499 2
Torx® 20 100 mm	1	063 203 96	41	40 07157 64501 2
 H 1 80 mm	1	063 112 94	48	40 07157 64487 9
H 2 100 mm	1	063 223 94	57	40 07157 64489 3
 Z 1 80 mm	1	063 112 95	41	40 07157 64491 6
Z 2 100 mm	1	063 223 95	57	40 07157 64493 0
 SQ0 (1,75 mm) 100 mm	1	063 000 94	34	40 07157 64503 6
SQ1 (2,30 mm) 100 mm	1	063 100 94	37	40 07157 64505 0
SQ2 (2,80 mm) 100 mm	1	063 200 94	57	40 07157 64507 4
SQ3 (3,30 mm) 100 mm	1	063 300 94	57	40 07157 64509 8

Высокопроизводительная
трещотка с поворотным
механизмом на 180°



ERGONOMIC - единственная рукоятка,
адаптирующаяся к руке каждого пользователя

ERGONOMIC® K (pat.)



Преимущества трещотки, поворотной отвертки и
эргономичной рукоятки в одном инструменте

Сверхпрочный храповой механизм с мелкими
зубьями (вплоть до 50 Нм, 48 зубьев,
угол поворота 7,5°)

Поворотный механизм передает
максимальный крутящий момент
(вплоть до 50 Нм)

Специально для мобильного использования

Непревзойденная скорость и мощность даже в
труднодоступных местах

Ориентированный на пользователя ассортимент
с 50-миллиметровыми битами и головками



ERGONIC K доступен для специального мобильного использования при различных ориентированных на пользователя работах с битами и головками в прочном кейсе StrongBox или компактном поясном чехле.

Быстрый, сильный, универсальный.

Мягкий компонент в рукоятке адаптируется к руке пользователя и обеспечивает уникальный комфорт при работе, в то время как трещотка с 48 мелкими зубьями обеспечивает высокую скорость работы, а чрезвычайно прочная (вплоть до 50 Нм) поворотная головка позволяет закручивать головки в труднодоступных местах.



ERGONIC K - это уникальное сочетание запатентованной ERGONIC- рукоятки с высокоэффективной трещоткой, поворотным механизмом на 180° и быстроразъемным патроном.





060



	Артикул		EAN - код
	060 716 04	590	40 07157 64513 5
(12 x)	Биты E6,3 x 50 mm 4,0 x 0,8 / 6,5 x 1,2 PZ 1 / PZ 2 / PZ 3 PH 1 / PH 2 / PH 3 Torx ^R 15 / Torx ^R 20 / Torx ^R 25 / Torx ^R 30		
(3 x)	Биты под головки E 6,3 x 66 8 / 10 / 13 mm Эргономичная К ручка 181 x 38,5 mm Поясная сумка 290 x 250 x 20 mm		



060



	Артикул		EAN - код
	060 720 06	700	40 07157 64515 9
(12 x)	Биты E6,3 x 50 mm 4,0 x 0,8 / 6,5 x 1,2 PZ 1 / PZ 2 / PZ 3 PH 1 / PH 2 / PH 3 Torx ^R 15 / Torx ^R 20 / Torx ^R 25 / Torx ^R 30		
(5 x)	Головки 7 / 8 / 10 / 12 / 13 mm Рукоятка 181 x 38,5 mm Переходник E6,3 с 1/4" (50 mm) Держатель бит E6,3 x 150 mm Прочный кейс 230 x 130 x 56 mm		



060



1/4"

	Артикул		EAN - код
	060 722 06	890	40 07157 64841 9
(15 x) Биты E6,3 x 50 mm			
4,0 x 0,8 / 6,5 x 1,2			
PZ 1 / PZ 2 / PZ 3			
PH 1 / PH 2 / PH 3			
Torx ^R 15 / Torx ^R 20 / Torx ^R 25 / Torx ^R 30			
Hex 3,0 mm / 4,0 mm / 5,0 mm			
(5 x) Головки			
7 / 8 / 10 / 12 / 13 mm			
Переходник E6,3 с 1/4" (50 mm)			
Прочный кейс			



438



1/4"

	Артикул		EAN - код
	438 999 40	242	40 07157 64539 5

Двухкомпонентная рукоятка, покрытие которой выполнено из мягкого противоскользящего материала для передачи усилия

SMART

Отвертка и Т-образная рукоятка в одном устройстве



Эргономичный усовершенствованный дизайн

Заменяет 48 различных инструментов

Стержни изготовлены из высококачественной стали, превышающей требования ISO и DIN почти на 100 %

Дизайн рукоятки не позволяет инструменту скатываться с поверхности

Подходит для всего ассортимента 1/4

Черный наконечник для точной посадки





Полный набор из 48 инструментов в одном кейсе! Каждый стержень точно обработан и идеально закален, удобное расположение и легкий доступ.

Профессиональное качество и отличная универсальность

SMART - это уникальная система сменных стержней с двухкомпонентной поворотной рукояткой, которую можно использовать как отвертку и Т-образную рукоятку одновременно.



Новая улучшенная конструкция позволяет выполнять операции одной рукой: для смены отвертки и Т-образной рукоятки не требуется вынимать лезвие!





060



	Артикул		EAN - код
	060 813 06	1090	40 07157 60413 2
(12 x)	Стержень 1/4" x 160 mm		
	PZ 1 – 5,0 x 0,8 / PZ 2 – 6,0 x 1,0 / PZ 3 – 7,0 x 1,2 / PH 1 – 4,0 x 0,8 / PH 2 – PH 3		
	3 mm – 4 mm / 5 mm – 6 mm		
	Torx® 6 – Torx® 7 / Torx® 8 – Torx® 9 / Torx® 10 – Torx® 15 / Torx® 20 – Torx® 25 / Torx® 30 – Torx® 40		
	Рукоятка 105 x 39 mm		
	Прочный кейс 230 x 130 x 56 mm		



060



	Артикул		EAN - код
	060 809 04	566	40 07157 60425 5
(8 x)	Стержень		
	PZ 1 - 5,0 x 0,8 / PZ 2 - 6,0 x 1,0 / PZ 3 - 7,0 x 1,2		
	PH 1 - 4,0 / PH 2 - PH 3		
	5 mm - 6 mm		
	Torx® 20 - Torx® 25 / Torx® 30 - Torx® 40		
	Рукоятка 105 x 39 mm		
	Поясная сумка		





060



	Артикул		EAN - код
Кейс, 29 шт.	060 815 06	985	40 07157 60415 6
(16 x) Биты С 6,3 x 25 mm			
PZ 1 / PZ 2 / PZ 3 / PH 1 / PH 2 / PH 3			
5 mm / 6 mm / 3,5 x 0,6 / 4,0 x 0,8 / 6,5 x 1,2			
Torx® 15 / Torx® 20 / Torx® 25 / Torx® 30 / Torx® 40			
Держатель бит с быстросъемным патроном			
(7 x) Головки			
4 / 5 / 5,5 / 6 / 8 / 10 / 13 mm			
Переходник 1/4" – С 6,3 (Art.No. 097 018 10)			
Удлинитель 1/4" – Е 6,3 (Art.No. 097 150 14)			
Удлинитель для головок 75 mm			
Трещотка Ergonic 1/4"			
Рукоятка 105 x 39 mm			
Прочный кейс 230 x 130 x 56 mm			



M-TEC

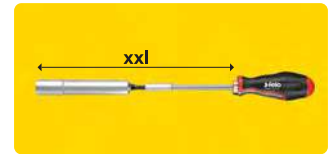

060



	Артикул		EAN - код
	060 820 06	1268	40 07157 60421 7
(7 x) М-Тес 1/4"	5,5 mm x 116 mm / 6 mm x 116 mm / 7 mm x 116 mm / 8 mm x 116 mm 10 mm x 133 mm / 13 mm x 133 mm 17 x 158 mm		
	Держатель бит 1/4" x 47 mm		
	Держатель бит 1/4" x 155 mm		
(10 x) Биты С 6,3 x 25 mm	PZ 1 / PZ 2 / PH 1 / PH 2 3,5 x 0,6 / 4,0 x 0,8 Torx® 15 / Torx® 20 / Torx® 25 / Torx® 30		
	Рукоятка 105 x 39 mm		
	Прочный кейс 230 x 130 x 56 mm		

068



				Артикул		EAN - код
5,5 mm	116 mm	1/4"	1	068 055 24	50	40 07157 60541 2
6 mm	116 mm	1/4"	1	068 060 24	66	40 07157 60543 6
7 mm	116 mm	1/4"	1	068 070 24	69	40 07157 60545 0
8 mm	116 mm	1/4"	1	068 080 24	72	40 07157 60547 4
10 mm	133 mm	1/4"	1	068 100 24	87	40 07157 60549 8
13 mm	133 mm	1/4"	1	068 130 24	137	40 07157 60551 1
17 mm	158 mm	1/4"	1	068 170 24	217	40 07157 60553 5

НОВИНКА



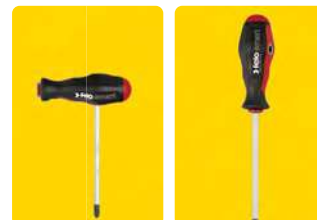
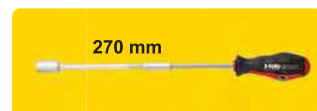
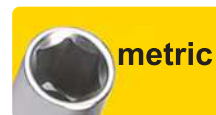

060

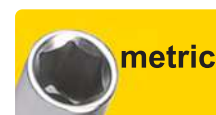

	Артикул		EAN - код
Кейс, 20 шт.	060 920 06	1268	40 07157 52953 4
(8 x) Головки E 6,3 x 155 5,5 / 6 / 7 / 8 / 10 / 11 / 13 / 17			
Держатель бит 1/4" x 155 mm			
(10 x) Биты C 6,3 x 25 mm PH 1 / PH 2 - PZ 1 / PZ 2 3,5 x 0,6 / 5,5 x 1,0 Torx® 15 / 20 / 25 / 30			
Рукоятка 105 x 39 mm			
Металлический кейс 220 x 130 x 56 mm			

068



			Артикул		EAN - код
5,5 mm	155 mm E 6,3 / 1/4"	1	068 055 04	52	40 07157 52709 7
6 mm	155 mm E 6,3 / 1/4"	1	068 060 04	52	40 07157 52711 0
7 mm	155 mm E 6,3 / 1/4"	1	068 070 04	57	40 07157 50302 2
8 mm	155 mm E 6,3 / 1/4"	1	068 080 04	60	40 07157 50304 6
10 mm	155 mm E 6,3 / 1/4"	1	068 100 04	64	40 07157 50306 0
11 mm	155 mm E 6,3 / 1/4"	1	068 110 04	73	40 07157 52713 4
13 mm	155 mm E 6,3 / 1/4"	1	068 130 04	76	40 07157 50308 4
17 mm	155 mm E 6,3 / 1/4"	1	068 170 04	102	40 07157 52715 8

060



	Артикул		EAN - код
Кейс, 20 шт.	060 920 36	1286	40 07157 52953 4
(8 x) Головки Е 6,3 x 155 7/32" 1/4" 9/32" 5/16" 3/8" 7/16" 1/2" 9/16"			
Держатель бит 1/4" x 47 mm			
Держатель бит / Bitholder 1/4"			
(10 x) Биты С 6,3 x 25 mm PZ 1 / PZ 2 / PH 1 / PH 2 / 3,5 x 0,6 / 5,5 x 1,0 Torx® 15 / 20 / 25 / 30			
Рукотка 105 x 39 mm			
Металлический кейс 220 x 110 x 35 mm			

068



			Артикул		EAN - код
7/32"	155 mm E 6,3 / 1/4"	1	068 555 04	51	40 07157 53195 7
1/4"	155 mm E 6,3 / 1/4"	1	068 635 04	52	40 07157 53197 1
9/32"	155 mm E 6,3 / 1/4"	1	068 714 04	57	40 07157 53199 5
5/16"	155 mm E 6,3 / 1/4"	1	068 793 04	59	40 07157 53201 5
3/8"	155 mm E 6,3 / 1/4"	1	068 952 04	64	40 07157 53203 9
7/16"	155 mm E 6,3 / 1/4"	1	068 111 04	72	40 07157 53205 3
1/2"	155 mm E 6,3 / 1/4"	1	068 127 04	77	40 07157 53207 7
9/16"	155 mm E 6,3 / 1/4"	1	068 142 04	77	40 07157 53209 1

069



Артикул



EAN - код

069 205 00

105

40 07157 60427 9

069



Артикул



EAN - код

069 105 00

105

40 07157 32180 0

389



Артикул



EAN - код

389 900 00

80

40 07157 50456 2



				Артикул		EAN - код
PH 1 - 4,0 x 0,8	160 mm	1/4"	1	062 104 04	42	40 07157 32116 9
PH 1 - 7,0 x 1,2	160 mm	1/4"	1	062 107 04	43	40 07157 50312 1
PH 2 - PH 3	160 mm	1/4"	1	062 023 04	44	40 07157 32118 3
PH 2 - 6,0 x 1,0	160 mm	1/4"	1	062 206 04	41	40 07157 50310 7
PZ 1 - 5,0 x 0,8	160 mm	1/4"	1	061 105 04	42	40 07157 32110 7
PZ 2 - 6,0 x 1,0	160 mm	1/4"	1	061 206 04	43	40 07157 32112 1
PZ 3 - 7,0 x 1,2	160 mm	1/4"	1	061 307 04	44	40 07157 32114 5
3 mm - 4 mm	160 mm	1/4"	1	064 034 04	44	40 07157 32106 0
5 mm - 6 mm	160 mm	1/4"	1	064 056 04	45	40 07157 32130 5
Torx® 06 - Torx® 07	160 mm	1/4"	1	066 067 04	42	40 07157 32096 4
Torx® 08 - Torx® 09	160 mm	1/4"	1	066 089 04	41	40 07157 32098 8
Torx® 10 - Torx® 15	160 mm	1/4"	1	066 115 04	41	40 07157 32100 8
Torx® 20 - Torx® 25	160 mm	1/4"	1	066 225 04	42	40 07157 32102 2
Torx® 30 - Torx® 40	160 mm	1/4"	1	066 340 04	45	40 07157 32104 6
SQ 0 - SQ 1	160 mm	1/4"	1	065 001 04	46	40 07157 50346 6
SQ 2 - SQ 3	160 mm	1/4"	1	065 023 04	48	40 07157 50348 0
Torx®TR 10 H - Torx®TR 15 H	160 mm	1/4"	1	067 115 04	46	40 07157 32120 6
Torx®TR 20 H - Torx®TR 25 H	160 mm	1/4"	1	067 225 04	46	40 07157 32122 0
Torx®TR 30 H - Torx®TR 45 H	160 mm	1/4"	1	067 340 04	48	40 07157 32124 4

068



				Артикул		EAN - код
	155 mm	1/4"	1	068 635 14	62	40 07157 53179 7

097



				Артикул		EAN - код
	150 mm	E 6,3 / 1/4"	1	097 150 14	62	40 07157 32128 2

Усиленный механизм трещотки высшего качества со сверхтонкими зубьями (> 100 Нм, 72 зуба, угол храпования 5°).



Головки безопасно фиксируются и снимаются при помощи кнопки-выталкивателя

Рукоятка надежно соединена с трещоткой

R-GO

Наборы инструментов с храповым механизмом 1/4 ERGONIC: безупречно и надежно



EP 1963072

Запатентованные рукоятки ERGONIC дают максимальный комфорт в работе

Инструмент хранится в надежном кейсе Strong Box

Высокое качество всех деталей: гарантия 15 лет.



Ящики для инструментов
Трещотка R-GO и все рукоятки содержат тщательно подобранные и продуманные наборы точно обработанных и прочных бит, адаптеров и удлинителей для широкого спектра применений, даже с электроинструментами.

трещотка R-GO и все ручки оснащены запатентованной технологией ERGONIC. Они адаптируются к руке пользователя и обеспечивают исключительный комфорт при работе.



Чрезвычайно сильный храповой механизм выдерживает усилие до 100 Нм и обладает сверхтонким зубчатым зацеплением с 72 зубцами и углом поворота 5°.



057



	Артикул		EAN - код
Отвертка, 36 шт.	057 836 16	955	40 07157 61547 3
	ERGONIC трещетка 1/4"		
	ERGONIC Stubby 1/4" / ERGONIC Stubby 1/4"		
(13 x)	Головки 4 / 4,5 / 5 / 5,5 / 6 / 7 / 8 / 9 / 10 / 11 / 12 / 13 / 14 mm		
(15 x)	Биты (С6,3 x 25 mm) 4,0 x 0,8 / 5,5 x 1,0 4 / 5 / 6 mm PH 1 / 2 / 3 PZ 1 / 2 Torx® 10 / 15/ 20/ 25/ 30		
	Удлинитель (100 mm) 1/4" - 1/4"		
	Удлинитель (50 mm) 1/4" - 1/4"		
	U- соеинение 1/4"		
	Держатель бит E6,3 x 58 mm		
	Переходник E 6,3 - 1/4" (50 mm)		
	Переходник 1/4" SQ - 1/4" Hex		
	Прочный кейс 230 x 130 x 56 mm		

057



	Артикул		EAN - код
Отвертка, 19 шт.	057 819 06	955	40 07157 61555 8
	ERGONIC трещетка 1/4"		
	ERGONIC Отвертка 1/4" переходник с головки		
(13 x)	Головки 4 / 4,5 / 5 / 5,5 / 6 / 7 / 8 / 9 / 10 / 11 / 12 / 13 / 14 mm		
	Удлинитель (100 mm) 1/4" - 1/4"		
	Удлинитель (50 mm) 1/4" - 1/4"		
	U- соединение 1/4"		
	Переходник E 6,3 - 1/4" (50 mm)		
	Прочный кейс 230 x 130 x 56 mm		



M-TEC



057







	Артикул		EAN - код
10 шт.	057 810 06	1050	40 07157 61553 4
Трещотка Ergonic 1/4"			
Отвертка Ergonic с посадкой под головки 1/4"			
(6 x)	М-Тес Головки		
	5,5 / 6 / 7 / 8 / 10 / 13 mm		
	Удлинитель (100 mm) 1/4" - 1/4"		
	U- соединение 1/4"		
	Прочный кейс 230 x 130 x 56 mm		

M-TEC



096



				Артикул		EAN - код
5,5 mm	86	1/4"	1	096 055 20	31	40 07157 61713 2
6 mm	86	1/4"	1	096 060 20	33	40 07157 61715 6
7 mm	86	1/4"	1	096 070 20	41	40 07157 61717 0
8 mm	86	1/4"	1	096 080 20	45	40 07157 61719 4
10 mm	103	1/4"	1	096 100 20	57	40 07157 61721 7
13 mm	103	1/4"	1	096 130 20	114	40 07157 61723 1



057



Артикул



EAN - код

057 827 06

1060

41 07157 62371 3

Трещотка Ergonic 1/4"

Отвертка Ergonic с посадкой под головки 1/4"

(21 x)

Головки

4 / 4,5 / 5 / 5,5 / 6 / 7 / 8 / 9 / 10 / 11 / 12 / 13 / 14 mm

3/16" | 7/32" | 1/4" | 9/32" | 5/16" | 3/8" | 7/16" | 1/2"

Удлинитель (100 mm) 1/4" - 1/4"

Удлинитель (50 mm) 1/4м - 1/4м

U- соединение 1/4"

Переходник E 6,3 - 1/4м (50 mm)

Прочный кейс 230 x 130 x 56 mm



057



Артикул



EAN - код

057 836 06

900

40 07157 61557 2

ERGONIC трещотка 1/4"

ERGONIC 438 Отвертка с Держатель бит

(30 x)

Биты (С6,3 x 25 mm)

3,0 x 0,5 / 4,0 x 0,8 / 5,5 x 1,0 / 6,5 x 1,2

2 mm / 3 mm / 4 mm / 5 mm / 6 mm

PH 0 / PH 1 / PH 2 / PH 3

PZ 1 / PZ 2 / PZ 3

Torx^R 5 / Torx^R 6 / Torx^R 7 / Torx^R 8 / Torx^R 10 /

SQ 1 / SQ 2

Spanner 6 / Spanner 8

Удлинитель (100 mm) 1/4" - 1/4"

Удлинитель (50 mm) 1/4м - 1/4м

Держатель бит E6,3 x 58 mm

Переходник 1/4" SQ - 1/4" Hex

Прочный кейс 230 x 130 x 56 mm



Inch



057



	Артикул		EAN - код
36 шт.	057 836 56	955	40 07157 62053 8
Трещотка Ergonic 1/4"			
ERGONIC Короткая отвертка 1/4"			
(13 x) Головки	1/8" 9/64" 5/32" 3/16" 7/32" 1/4" 9/32" 5/16" 11/32" 3/8" 7/16" 1/2" 9/16"		
(15 x) Биты (С6,3 x 25 mm)	4,0 x 0,8 / 5,5 x 1,0		
	PH 1/ 2 / 3		
	Torx [®] 8 / 10 / 15 / 20 / 25 / 30		
	SQ 0 (1,75 mm) / 1 (2,30 mm) / 2 (2,80 mm) / 3 (3,30 mm)		
	Удлинитель (100 mm) 1/4" - 1/4"		
	Удлинитель (50 mm) 1/4" - 1/4"		
	U- соединение 1/4"		
	Держатель бит E6,3 x 58 mm		
	Переходник E 6,3 - 1/4" (50 mm)		
	Переходник 1/4" SQ- 1/4" Hex		
	Прочный кейс 230 x 130 x 56 mm		



Inch



057



	Артикул		EAN - код
Отвертка, 19 шт.	057 819 56	955	40 07157 62055 2
Трещотка Ergonic 1/4"			
Отвертка Ergonic с посадкой под головки 1/4"			
(13 x) Головки	1/8" 9/64" 5/32" 3/16" 7/32" 1/4" 9/32" 5/16" 11/32" 3/8" 7/16" 1/2" 9/16"		
	Удлинитель (100 mm) 1/4" - 1/4"		
	Удлинитель (50 mm) 1/4" - 1/4"		
	U- соединение 1/4"		
	Переходник E 6,3 - 1/4" (50 mm)		
	Прочный кейс 230 x 130 x 56 mm		



Усиленный механизм трещетки высшего качества с сверхтонкими зубьями (> 65, 60 зубьев, угол поворота 6°).

Прямая фиксация бит в трещетке позволяет работать в труднодоступных местах



Слегка изогнутая рукоятка делает работу более комфортной и защищает пальцы.

XS

Карманные наборы инструментов предназначены для тяжелой работы в ограниченном пространстве



Трещотка целиком изготовлена из хром-ванадиевой стали

Инструмент хранится в надежном водонепроницаемом мини кейсе

Высокое качество всех деталей: гарантия 15 лет!



057



	Артикул		EAN - код
18 шт.	057 718 06	420	40 07157 61561 9
Мини трещотка 1/4"			
(7 x)	Головки		
	5 / 5,5 / 6 / 7 / 8 / 10 / 13 mm		
(7 x)	Биты (С6,3 x 25 mm)		
	PH 1 / PH 2 / PH 3		
	PZ 2		
	Torx® 15 / Torx® 20 / Torx® 25		
	Удлинитель (50 mm) 1/4" - 1/4"		
	Переходник С 6,3 - 1/4" (25 mm)		
	Держатель бит Е6,3 x 58 mm		
	XS- Прочный кейс		

057



	Артикул		EAN - код
23 шт.	057 723 06	423	40 07157 64197 7
Мини трещотка 1/4"			
(5 x)	Головки		
	6 / 7 / 8 / 10 / 13 mm		
(15 x)	Биты (С6,3 x 25 mm)		
	4 / 5 / 6 mm		
	PH 1 / PH 2 / PH 3		
	PZ 1 / PZ 2 / PZ 3		
	Torx® 10 / Torx® 15 / Torx® 20 / Torx® 25 / Torx® 30 / Torx® 40		
	Переходник С 6,3 - 1/4" (25 mm)		
	Держатель бит Е6,3 x 58 mm		
	XS- Прочный кейс		

057



	Артикул		EAN - код
33 шт.	057 733 06	425	40 07157 61545 9
Мини трещотка 1/4"			
(30 x) Биты (С6,3 x 25 mm)			
3,0 x 0,5 / 4,0 x 0,8 / 6,5 x 1,2			
2 / 2,5 / 3 / 4 / 5 / 6 / 8 mm			
PH 0 / PH 1 / 2 x PH 2 / PH 3			
PZ 1 / 2 x PZ 2 / PZ 3			
Torx® 6 / Torx® 7 / Torx® 8 / Torx® 9			
Torx® TR 10 H / Torx® TR 15 H / Torx® TR 20 H / Torx® TR 25 H / Torx® TR 27 H / Torx® TR 30 H / Torx® TR 40 H			
Переходник С 6,3 - 1/4" (25 mm)			
Переходник Е6,3 x 58 mm			
XS- Прочный кейс			

057



	Артикул		EAN - код
18 шт.	057 718 56	420	40 07157 62059 0
Мини трещотка 1/4"			
(7 x) Головки			
3/16" 7/32" 1/4" 9/32" 5/16" 3/8" 1/2"			
(7 x) Биты (С6,3 x 25 mm)			
4,0 x 0,8 / 5,5 x 1,0 / 6,5 x 1,2			
PH 1 / PH 2 / PH 3			
SQ 2			
Удлинитель (50 mm) 1/4" - 1/4"			
Переходник С 6,3 - 1/4" (25 mm)			
Переходник Е6,3 x 58 mm			
XS- Прочный кейс			



020



1/4"

	Артикул		EAN - код
30 шт.	020 730 06	334	40 07157 61563 3
(28 x) Биты С 6,3 x 25 mm			
3,0 x 0,5 / 4,0 x 0,8 / 5,5 x 1,0 / 6,5 x 1,2			
PH 0 / PH 1 / PH 2 / PH 3 / PZ 1 / PZ 2 / PZ 3			
2 mm / 3 mm / 4 mm / 5 mm / 6 mm			
Torx® 5 / Torx® 6 / Torx® 7 / Torx® 8 / Torx® 10 / Torx® 15 / Torx® 20 / Torx® 25 / Torx® 30 / Torx® 40			
Spanner 6 / Spanner 8			
ERGONIC Короткая отвертка 1/4"			
Держатель бит Е 6,3 x 58 mm			
XS- Прочный кейс			



020



1/4"

	Артикул		EAN - код
30 шт.	020 730 16	340	40 07157 51565 0
Биты С 6,3 x 25 mm			
024 2,0 / 2,5 / 3,0 / 4,0 mm			
028 XZN M 6 / XZN M 5 / XZN M 4			
029 TS 10 / TS 8 / TS 6 / TS 4 / TS 2 / TS 0			
027 TORX® TR 30 H / TR 25 H / TR 20 H / TR 15 H / TR 10 H			
029 Tri-Wing 5 / 4 / 3 / 2 / 1			
020 Spanner 6 / 8 / 10			
028 Clutch 5/32", 1/4"			
ERGONIC Короткая отвертка 1/4"			
Держатель бит Е 6,3 x 58 mm			
XS- Прочный кейс			

020



	Артикул		EAN - код
Набор 38 шт.	020 738 06	346	40 07157 61565 7
(36 x) Биты С 6,3 x 25 mm			
5,5 x 1,0 / 6,5 x 1,2			
2 mm / 3 mm / 4 mm / 5 mm / 6 mm			
2 x PZ 1 / 5 x PZ 2 / 2 x PZ 3			
PH 0 / 2 x PH 1 / 4 x PH 2 / 2 x PH 3			
Torx [®] 6 / Torx [®] 7 / Torx [®] 8 / Torx [®] 10 / Torx [®] 15 / Torx [®] 20 / Torx [®] 25 / Torx [®] 30 / Torx [®] 40 /			
SQ 1 / SQ 2			
Автоматический держатель Felo Star			
Держатель бит Е6,3 x 58 mm			
XS- Прочный кейс			

020



	Артикул		EAN - код
Набор 21 шт.	020 821 36	262	40 07157 64945 4
(20 x) Биты			
5,5 x 1,0 / 6,5 x 1,2			
3 x PZ 2 / 1 x PZ 3			
3 x PH 2 / 1 x PH			
3 x Torx [®] 20 / 3 x Torx [®] 25 / 3 x Torx [®] 30 / 3 x Torx [®] 40 /			
Держатель бит			
XS- Прочный кейс			



020



	Артикул		EAN - код
Набор 35 шт.	020 735 16	365	40 07157 61567 1
(28 x) Биты С 6,3 x 25 mm			
4,0 x 0,8 / 5,5 x 1,0 / 6,5 x 1,2			
3 mm / 4 mm / 5 mm			
PH 0 / 2 x PH 1 / 2 x PH 2 / PH 3			
2 x PZ 1 / 3 x PZ 2 / PZ 3			
Torx® 5 / Torx® 6 / Torx® 7 / Torx® 8 / Torx® 10 / Torx® 15 / Torx® 20 / Torx® 25 / Torx® 30 / Torx® 40			
(6 x) Биты Е 6,3 x 50 mm			
PZ 1 / PZ 2			
PH 2			
Torx® 20 / Torx® 25 / Torx® 30			
Держатель бит Е6,3 x 58 mm			
XS- Прочный кейс			



020



	Артикул		EAN - код
Набор 35 шт.	020 735 26	365	40 07157 63529 7
(28 x) Биты С 6,3 x 25 mm			
1 x Torx® 5 / 1 x Torx® 6 / 1 x Torx® 7 / 1 x Torx® 8 / 1 x Torx® 9			
2 x Torx® 10 / 4 x Torx® 15 / 4 x Torx® 20 / 4 x Torx® 25			
1 x Torx® 27 / 4 x Torx® 30 / 4 x Torx® 40			
(6 x) Биты Е 6,3 x 50 mm			
Torx® 10 / Torx® 15 / Torx® 20 / Torx® 25 / Torx® 30 / Torx® 40			
Держатель бит Е6,3 x 58 mm			
XS- Прочный кейс			



020



1/4"

	Артикул		ЕАН - код
Набор 19 шт.	020 719 46	262	40 07157 63187 9
(18 x) ИМПАКТ Биты С6,3 x 25 mm			
1 x PZ 1 / 2 x PZ 2 / 2 x PZ 3			
1 x PH 1 / 2 x PH 2 / 2 x PH 3			
1 x Torx® 10 / 1 x Torx® 15 / 1 x Torx® 20			
2 x Torx® 25 / 2 x Torx® 30 / 1 x Torx® 40			
Держатель бит ИМПАКТ Е6,3 x 58 mm			
XS- Прочный кейс			



020



1/4"

	Артикул		ЕАН - код
Набор 19 шт.	020 719 06	260	40 07157 63555 6
(18 x) Industrial Биты С6,3 x 25 mm			
1 x PZ 1 / 2 x PZ 2 / 2 x PZ 3			
1 x PH 1 / 2 x PH 2 / 2 x PH 3			
1 x Torx® 10 / 1 x Torx® 15 / 1 x Torx® 20			
2 x Torx® 25 / 2 x Torx® 30 / 1 x Torx® 40			
Держатель бит ИМПАКТ Е6,3 x 58 mm			
XS- Прочный кейс			



057



Артикул		EAN - код
057 635 01	118	40 07157 61569 5

097



				Артикул		EAN - код
25 mm	1/4"	C 6,3	1	097 019 10	25	40 07157 61685 2

497



Артикул		EAN - код
497 635 41	128	40 07157 61481 0

097



				Артикул		EAN - код
25 mm	1/4"	C 6,3	6	097 018 10	14	40 07157 30851 1

097



				Артикул		EAN - код
75 mm	E 6,3	1/4"	1	097 070 10	45	40 07157 52423 2

097

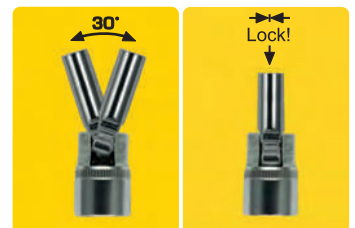



			Артикул		EAN - код
50 mm	1/4"	1	097 050 10	22	40 07157 61683 8
100 mm	1/4"	1	097 100 10	43	40 07157 61681 4

097

1/4" 



	Артикул		ЕАН - код
1	097 000 10	22	40 07157 61729 3





096



mm				Артикул		ЕАН - код
4	25	1/4"	1	096 040 10	10	40 07157 61687 6
4,5	25	1/4"	1	096 045 10	10	40 07157 61689 0
5	25	1/4"	1	096 050 10	10	40 07157 61691 3
5,5	25	1/4"	1	096 055 10	10	40 07157 61693 7
6	25	1/4"	1	096 060 10	11	40 07157 61695 1
7	25	1/4"	1	096 070 10	11	40 07157 61697 5
8	25	1/4"	1	096 080 10	12	40 07157 61699 9
9	25	1/4"	1	096 090 10	12	40 07157 61701 9
10	25	1/4"	1	096 100 10	12	40 07157 61703 3
11	25	1/4"	1	096 110 10	18	40 07157 61705 7
12	25	1/4"	1	096 120 10	21	40 07157 61707 1
13	25	1/4"	1	096 130 10	23	40 07157 61709 5
14	25	1/4"	1	096 140 10	31	40 07157 61711 8

096



Inch				Артикул		ЕАН - код
1/8"	25	1/4"	1	096 200 10	10	40 07157 62757 5
9/64"	25	1/4"	1	096 210 10	10	40 07157 62759 9
5/32"	25	1/4"	1	096 220 10	10	40 07157 62761 2
3/16"	25	1/4"	1	096 230 10	10	40 07157 62763 6
7/32"	25	1/4"	1	096 240 10	11	40 07157 62765 0
1/4"	25	1/4"	1	096 250 10	11	40 07157 62767 4
9/32"	25	1/4"	1	096 260 10	12	40 07157 62769 8
5/16"	25	1/4"	1	096 270 10	12	40 07157 62771 1
11/32"	25	1/4"	1	096 280 10	12	40 07157 62773 5
3/8"	25	1/4"	1	096 290 10	18	40 07157 62775 9
7/16"	25	1/4"	1	096 300 10	21	40 07157 62777 3
1/2"	25	1/4"	1	096 310 10	23	40 07157 62779 7
9/16"	25	1/4"	1	096 320 10	31	40 07157 62781 0

057



	Артикул	EAN - код
	6	057 981 06
(8 x)	4 mm / 5 mm / 5,5 mm / 6 mm / 7 mm 8 mm / 10 mm / 13 mm	172 40 07157 22198 8
(1 x) 097:	Переходник (Art.No. 097 013 10)	

НОВИНКА

056

1/2"



	Артикул	EAN - код
	056 813 18	2500 40 07157 64965 2
	Трещотка ERGONIC 1/2"	
	Удлинитель переходник 1/2" x 100 mm	
	Удлинитель переходник 1/2" x 250 mm	
(9 x)	Головки 13 / 14 / 15 / 16 / 17 / 18 / 19 / 21 / 22 mm	
	U-соединение 1/2"	





НОВИНКИ

497

1/2"

Артикул		EAN - код
497 835 40	485	40 07157 64869 3

097

1/2"



			Артикул		EAN - код
100 mm	1/2"	1	097 713 10	43	40 07157 64913 3
250 mm	1/2"	1	097 714 10	94	40 07157 64915 7

097

1/2"



	Артикул		EAN - код
1	097 920 10	22	40 07157 64917 1

099



mm				Артикул		EAN - код
13	38	1/2"	1	099 130 10	23	40 07157 64919 5
14	38	1/2"	1	099 140 10	23	40 07157 64921 8
15	38	1/2"	1	099 150 10	24	40 07157 64923 2
16	38	1/2"	1	099 160 10	24	40 07157 64925 6
17	38	1/2"	1	099 170 10	24	40 07157 64927 0
18	38	1/2"	1	099 180 10	25	40 07157 64929 4
19	38	1/2"	1	099 190 10	26	40 07157 64931 7
21	38	1/2"	1	099 210 10	27	40 07157 64933 1
22	38	1/2"	1	099 220 10	27	40 07157 64935 5

Каждая рукоятка индивидуально откалибрована и сертифицирована

Цветное кольцо с указанием диапазона крутящего момента



Простая регулировка крутящего момента



Динамометрические отвертки с точной регулировкой серии Nm (pat.)

Эргономичный усовершенствованный дизайн

Стержни изготовлены из хром-молибден-ванадиевой стали

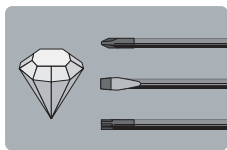

Превосходный крутящий момент, который превышает требования DIN и ISO на 100 %

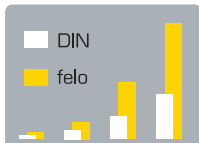

Точная настройка усилия сопровождается звуковыми и механическими сигналами

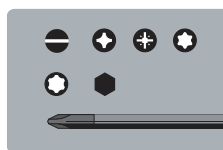

Черный наконечник для точной посадки

Сменные стержни для максимальной гибкости во всех областях применения



Регулирование крутящего момента 0,6 - 5,4 Nm

- выкручивание на 100% крутящего момента





100



1/4"

	Артикул		EAN - код
Нм-кейс 0,6Нм - 1,5Нм 14 шт.	100 991 16	1190	40 07157 52039 5
(11 x) Torx ^R 6 / Torx ^R 7 / Torx ^R 8			
6 IP / 7 IP / 8 IP / 9 IP			
3,0 x 0,5 / 3,5 x 0,6			
PH 0			
PZ 0			
Держатель бит			
Рукоятка 0,6Нм - 1,5Нм			
Инструмент регулировки			
Металлический кейс 220 mm x 110 mm x 35 mm			

100



1/4"

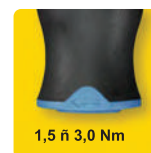



	Артикул		EAN - код
Нм-кейс 1,5Нм - 3,0Нм 14 шт.	100 992 16	1201	40 07157 52041 8
(11 x) Torx ^R 9 / Torx ^R 10 / Torx ^R 15			
9 IP / 10 IP / 15 IP			
4,0 x 0,8			
PH 1 / PH 2			
PZ 1 / PZ 2			
Держатель бит			
Рукоятка 1,5Нм - 3,0Нм			
Инструмент регулировки			
Металлический кейс 220 mm x 110 mm x 35 mm			

100

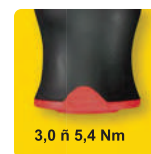

1/4"



	Артикул		EAN - код
Нм-кейс 3,0Нм - 5,4Нм 14 шт.	100 993 16	1296	40 07157 52043 2
(12 x) Torx ^R 15 / Torx ^R 20 / Torx ^R 25			
9 IP / 10 IP / 15 IP			
4,0 x 0,8			
PH 1 / PH 2			
PZ 1 / PZ 2			
Держатель бит			
Рукоятка 3,0Нм - 5,4Нм			
Инструмент регулировки			
Металлический кейс 220 mm x 110 mm x 35 mm			

100



Nm max	← →	+	☐	Артикул	g	EAN - код
0,6 ÷ 1,5 Nm	105	32	1	100 001 06	183	40 07157 52149 1

100



Nm max	← →	+	☐	Артикул	g	EAN - код
1,5 ÷ 3,0 Nm	105	32	1	100 002 06	183	40 07157 52151 4

100



Nm max	← →	+	☐	Артикул	g	EAN - код
3,0 ÷ 5,4 Nm	105	32	1	100 003 06	192	40 07157 52153 8

100



☐	Артикул	g	EAN - код
1	100 006 00	2	40 07157 53413 2

100



☐	Артикул	g	EAN - код
1	100 060 00	27	40 07157 52155 2



1/4"

				Артикул		ЕАН - код	
Torx® 6	170		1/4" 1	108 061 04	43	40 07157 51991 7	
Torx® 7	170		1/4" 1	108 071 04	43	40 07157 51993 1	
Torx® 8	170		1/4" 1	108 083 04	43	40 07157 51995 5	
Torx® 9	170		1/4" 1	108 093 04	43	40 07157 51997 9	
Torx® 10	170		1/4" 1	108 103 04	43	40 07157 51999 3	
Torx® 15	170		1/4" 1	108 153 04	44	40 07157 52001 2	
Torx® 20	170		1/4" 1	108 203 04	45	40 07157 52003 6	
Torx® 25	170		1/4" 1	108 253 04	46	40 07157 52005 0	
6 IP	170		1/4" 1	109 061 04	43	40 07157 52007 4	
7 IP	170			1/4" 1	109 071 04	43	40 07157 52009 8
8 IP	170	1/4" 1		109 083 04	43	40 07157 52011 1	
9 IP	170	1/4" 1		109 093 04	43	40 07157 52013 5	
10 IP	170	1/4" 1		109 103 04	43	40 07157 52015 9	
15 IP	170	1/4" 1		109 153 04	44	40 07157 52017 3	
20 IP	170	1/4" 1		109 203 04	44	40 07157 53791 1	
25 IP	170	1/4" 1		109 253 04	46	40 07157 57833 4	
3,0 x 0,5	170	1/4" 1		100 032 04	43	40 07157 52019 7	
3,5 x 0,6	170			1/4" 1	100 353 04	44	40 07157 52021 0
4,0 x 0,8	170			1/4" 1	100 043 04	44	40 07157 52023 4
5,5 x 1,0	170		1/4" 1	100 554 04	44	40 07157 61245 8	
PH 0	170		1/4" 1	102 001 04	43	40 07157 52025 8	
PH 1	170		1/4" 1	102 102 04	45	40 07157 52027 2	
PH 2	170		1/4" 1	102 203 04	46	40 07157 52029 6	
PZ 0	170		1/4" 1	101 001 04	43	40 07157 52031 9	
PZ 1	170		1/4" 1	101 102 04	45	40 07157 52033 3	
PZ 2	170		1/4" 1	101 203 04	47	40 07157 52035 7	
H 1 (+/-)	170		1/4" 1	106 102 04	45	40 07157 61247 2	
H 2 (+/-)	170		1/4" 1	106 203 04	47	40 07157 61249 6	
Z 1 (+/-)	170		1/4" 1	107 102 04	45	40 07157 57807 5	
Z 2 (+/-)	170		1/4" 1	107 203 04	47	40 07157 57809 9	
1,5 mm	170		1/4" 1	104 015 04	43	40 07157 61625 8	
2 mm	170		1/4" 1	104 020 04	43	40 07157 61627 2	
2,5 mm	170		1/4" 1	104 025 04	43	40 07157 61629 6	
3 mm	170		1/4" 1	104 030 04	44	40 07157 61631 9	
4 mm	170		1/4" 1	104 040 04	44	40 07157 61633 3	
Bithalter	170		1/4" 1	118 125 04	65	40 07157 52037 1	

VDE тонкие стержни для серии NM

Протестировано согласно EN 60900: 2012

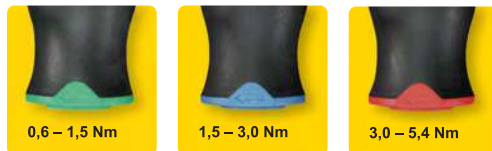
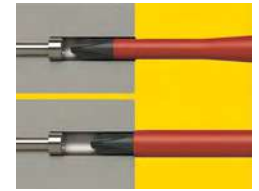

Nm VDE slim	↔	⬢	⬢	Артикул	📦	EAN - код
3,5 x 0,6	170	1/4"	1	100 353 94	23	40 07157 63865 6
4,0 x 0,8	170	1/4"	1	100 043 94	24	40 07157 63863 2
5,5 x 1,0	170	1/4"	1	100 554 94	26	40 07157 63867 0
PH 1	170	1/4"	1	102 102 94	26	40 07157 63873 1
PH 2	170	1/4"	1	102 203 94	31	40 07157 63875 5
PZ 1	170	1/4"	1	101 102 94	26	40 07157 63869 4
PZ 2	170	1/4"	1	101 203 94	31	40 07157 63871 7
H2 +/-	170	1/4"	1	106 203 94	31	40 07157 63877 9
Z1 +/-	170	1/4"	1	107 102 94	29	40 07157 63879 3
Z2 +/-	170	1/4"	1	107 203 94	31	40 07157 63881 6
Torx® T 10	170	1/4"	1	108 103 94	31	40 07157 64937 9
Torx® T 15	170	1/4"	1	108 153 94	31	40 07157 64939 3
Torx® T 20	170	1/4"	1	108 203 94	31	40 07157 64941 6
Torx® T 25	170	1/4"	1	108 253 94	31	40 07157 64943 0



Неправильно закрепленные винты представляют серьезную угрозу безопасности!

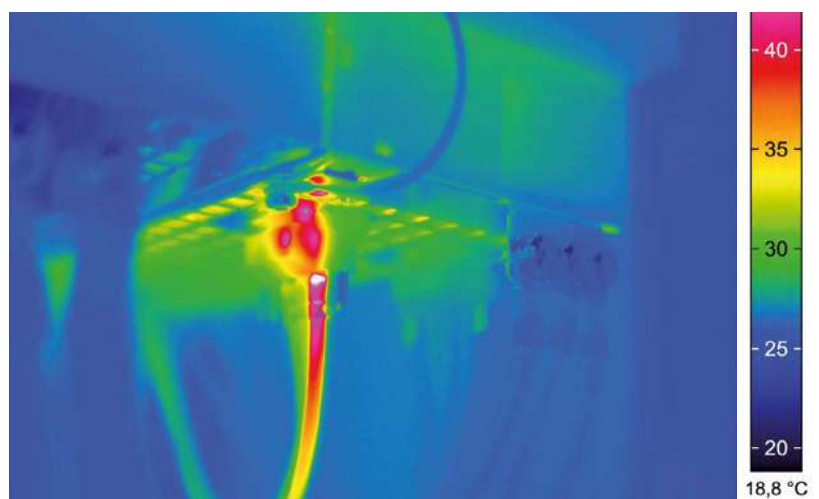

Сильно затянутые провода могут привести к накоплению тепла...

Свободно вращающийся колпачок рукоятки для минимального трения

Отверстие для удобного хранения



EAN- код на каждом товаре

Отвертки для точных работ Felo устанавливают стандарты во всех областях применения
серии 240/250

Комфортное мягкое внешнее покрытие для максимального крутящего момента

Эргономичный усовершенствованный дизайн

Дизайн рукоятки не позволяет инструменту скатываться с поверхности

Полноразмерный пластиковый сердечник

Стержни изготовлены из хром-молибден-ванадиевой стали



Отвертки для точных работ Felo также доступны с керамическими стержнями и соответствуют стандартам ESD

ESD Safe
10⁸ 1 0¹⁰ Ω



Превосходный крутящий момент, который превышает требования DIN и ISO на 100%

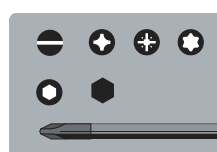

Черный наконечник для точной посадки



240



						Артикул		EAN - код
1,5 x 0,23	60	90	14	2,5	6	240 151 60	20	40 07157 31738 4
2,0 x 0,4	60	90	14	2,5	6	240 201 60	20	40 07157 31740 7
2,5 x 0,4	60	90	14	2,5	6	240 252 60	20	40 07157 31742 1
2,5 x 0,4	150	90	14	2,5	6	240 255 60	24	40 07157 31744 5
2,5 x 0,4	200	90	14	2,5	6	240 257 60	25	40 07157 31746 9
3,0 x 0,5	60	90	14	3,0	6	240 033 60	22	40 07157 31748 3
3,0 x 0,5	100	103	19	3,0	6	240 035 60	24	40 07157 31750 6
3,0 x 0,5	200	103	19	3,0	6	240 037 60	29	40 07157 31752 0
3,5 x 0,6	60	103	19	3,0	6	240 333 60	24	40 07157 61307 3
3,5 x 0,6	100	103	19	3,5	6	240 353 60	26	40 07157 31754 4
3,5 x 0,6	150	103	19	3,5	6	240 355 60	31	40 07157 31756 8
3,5 x 0,6	250	103	19	3,5	6	240 358 60	39	40 07157 31758 2
4,0 x 0,8	100	103	19	4,0	6	240 043 60	30	40 07157 31760 5
4,0 x 0,8	150	103	19	4,0	6	240 045 60	35	40 07157 31762 9
4,0 x 0,8	200	103	19	4,0	6	240 047 60	40	40 07157 31764 3

241



PZ						Артикул		EAN - код
0	60	90	14	3,0	6	241 001 60	19	40 07157 31766 7
1	60	103	19	4,5	6	241 102 60	31	40 07157 31768 1

242



PH						Артикул		EAN - код
000	60	90	14	2,5	6	242 000 60	20	40 07157 31770 4
00	60	90	14	2,5	6	242 009 60	20	40 07157 31772 8
0	60	90	14	3,0	6	242 001 60	21	40 07157 31774 2
1	60	103	19	4,5	6	242 102 60	29	40 07157 31776 6
1	150	103	19	4,5	6	242 105 60	41	40 07157 31778 0

243



Pentalobe						Артикул		EAN - код
P 2	60	90	14	2,5	6	243 021 60	20	40 07157 64005 5
P 5	60	90	14	2,5	6	243 051 60	20	40 07157 64007 9
P 6	60	90	14	2,5	6	243 061 60	20	40 07157 64009 3

245



Y0						Артикул		EAN - код
Y0	60	90	14	2,5	6	245 102 60	20	40 07157 64003 1

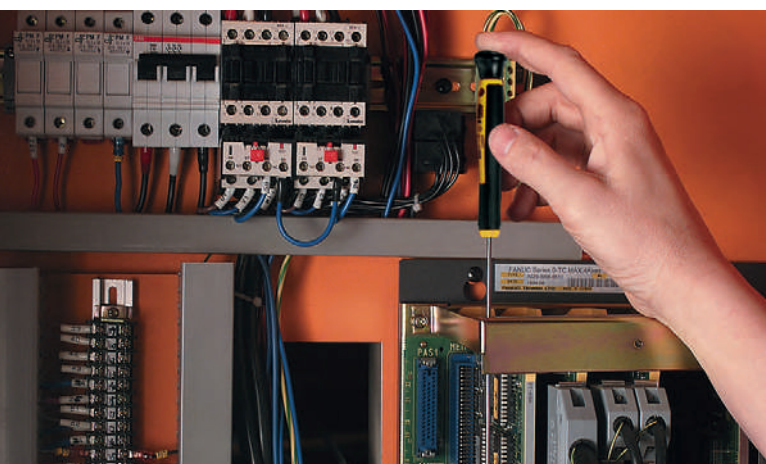



246



mm						Артикул		EAN - код
1,5	60	90	14	1,5	6	246 151 60	17	40 07157 31782 7
2	60	90	14	2,0	6	246 201 60	19	40 07157 31784 1
2,5	75	90	14	2,5	6	246 252 60	21	40 07157 31786 5
3	75	103	19	3,0	6	246 302 60	23	40 07157 31788 9

248



TORX [®]						Артикул		EAN - код
5	60	90	14	3,0	6	248 051 60	20	40 07157 31790 2
6	60	90	14	3,0	6	248 061 60	20	40 07157 31792 6
7	60	90	14	3,0	6	248 071 60	21	40 07157 31794 0
8	60	90	14	3,0	6	248 081 60	22	40 07157 31796 4
9	60	90	14	3,5	6	248 091 60	22	40 07157 31798 8
10	60	103	19	3,5	6	248 103 60	26	40 07157 31800 8
10	250	103	19	3,5	6	248 108 60	38	40 07157 50276 6
15	100	103	19	4,0	6	248 153 60	30	40 07157 31802 2
15	250	103	19	4,0	6	248 158 60	45	40 07157 50278 0
20	250	103	19	4,0	6	248 208 60	61	40 07157 50280 3

249



mm						Артикул		EAN - код
3	60	103	19		6	249 300 60	29	40 07157 50709 9
3,5	60	103	19		6	249 350 60	29	40 07157 50711 2
4	60	103	19		6	249 400 60	30	40 07157 50713 6
4,5	60	103	19		6	249 450 60	30	40 07157 50715 0
5	60	103	19		6	249 500 60	31	40 07157 50717 4
5,5	60	103	19		6	249 550 60	31	40 07157 50719 8



240



Артикул		EAN - код
240 961 66	195	40 07157 31844 2
(4 x) 240: 1,5 x 60 / 2,0 x 60 / 2,5 x 60 / 3,0 x 60		
(2 x) 242: Phillips 00 x 60 / Phillips 0 x 60		

248



Артикул		EAN - код
248 961 66	194	40 07157 31846 6
(4 x) 248: Torx [®] R6x60 / Torx [®] R7x60 / Torx [®] R8x60 / Torx [®] R9x60		
(2 x) 246: 1,5 mm x 60 mm / 2,0 mm x 60 mm		

243



Артикул		EAN - код
243 961 66	254	40 07157 64011 6
(1 x) 240: 2,5 x 0,4		
(1 x) 241: PH 000		
(3 x) 243: P 2 / P 5 / P 6		
(1 x) 245: Y 0		

249



	Артикул	EAN - код
(6 x) 249: 3,0 mm x 60 mm / 3,5 mm x 60 mm / 4,0 mm x 60 mm 4,5 mm x 60 mm / 5,0 mm x 60 mm / 5,5 mm x 60 mm	249 961 66	254 40 07157 50721 1

ESD Safe
10⁸ ñ 10¹⁰



250



	Артикул	EAN - код
(4 x) 250: 1,5 x 60 / 2,0 x 60 / 2,5 x 60 / 3,0 x 60	250 961 66	202 40 07157 31848 0
(2 x) 252: Phillips 00 x 60 / Phillips 0 x 60		



ESD Safe
10⁸ ñ 10¹⁰



250



	Артикул	EAN - код
1,5 x 0,23 60 90 14 2,5 6	250 151 60	20 40 07157 31806 0
2,0 x 0,4 60 90 14 2,5 6	250 201 60	21 40 07157 31808 4
2,5 x 0,4 60 90 14 2,5 6	250 252 60	21 40 07157 31810 7
3,0 x 0,5 60 90 14 3,0 6	250 033 60	23 40 07157 31812 1
3,0 x 0,5 100 103 19 3,0 6	250 035 60	24 40 07157 31814 5

251



PZ	Артикул	EAN - код
1 60 103 19 4,5 6	251 102 60	34 40 07157 64603 3

252



PH	Артикул	EAN - код
00 60 90 14 2,0 6	252 009 60	20 40 07157 31816 9
0 60 90 14 3,0 6	252 001 60	22 40 07157 31818 3
1 60 103 19 4,5 6	252 102 60	32 40 07157 31820 6

256



mm	Артикул	EAN - код
1,5 60 90 14 1,5 6	256 151 60	17 40 07157 64605 7
2 60 90 14 2,0 6	256 201 60	19 40 07157 64607 1
2,5 75 90 14 2,5 6	256 252 60	21 40 07157 64609 5
3 75 103 19 3,0 6	256 302 60	23 40 07157 64611 8

258



Torx Æ	Артикул	EAN - код
5 60 90 14 3,0 6	258 051 60	20 40 07157 64589 0
6 60 90 14 3,0 6	258 062 60	20 40 07157 64591 3
7 60 90 14 3,0 6	258 071 60	21 40 07157 64593 7
8 60 90 14 3,0 6	258 081 60	22 40 07157 64595 1
9 60 90 14 3,5 6	258 091 60	22 40 07157 64597 5
10 60 103 19 3,5 6	258 103 60	26 40 07157 64583 8
15 100 103 19 4,0 6	258 153 60	30 40 07157 64585 2
20 100 103 19 4,0 6	258 203 60	33 40 07157 64587 6



Отсек для хранения 7 бит



Эргономическая рукоятка для максимального комфорта и интенсивного использования

Гладкая, бесшовная ручка для максимального комфорта

Легкий доступ и замена бит, безопасно хранящихся внутри рукоятки

Комфортное мягкое внешнее покрытие для максимального крутящего момента



Универсальность и улучшенная эргономика

серии 370 (pat.)



серии 373

С держателем бит для электроинструмента

Держатель бит из нержавеющей стали и мощным магнитом



серии 374

Рукоятка с трещоткой

Реверсивная профессиональная трещотка - максимальный крутящий момент > 24 Нм



373



		Артикул		EAN - код
	6	373 108 05	160	40 07157 52227 6
(8 x)	4,0 X 0,8 / 5,5 x 1,0 / 6,5 x 1,2 PH 0 / PH 1 / PH 2 / PZ 1 / PZ 2			
		Артикул		EAN - код
	6	373 208 05	161	40 07157 52229 0
(8 x)	Bits C 6,3 x 25 mm 5,5 x 1,0 PH 1 / PH 2 / PZ 1 / PZ 2 Torx® 15 / Torx® 20 / Torx® 25			

374



		Артикул		EAN - код
	6	374 004 05	229	40 07157 52223 8
(8 x)	Bits C 6,3 x 25 mm 4,0 X 0,8 / 5,5 x 1,0 / 6,5 x 1,2 PH 0 / PH 1 / PH 2 / PZ 1 / PZ 2			
		Артикул		EAN - код
	6	374 204 05	229	40 07157 52225 2
(8 x)	Bits C 6,3 x 25 mm 5,5 x 1,0 PH 1 / PH 2 / PZ 1 / PZ 2 Torx® 15 / Torx® 20 / Torx® 25			

376



		Артикул		EAN - код
	6	376 041 05	188	40 07157 52221 4
(8 x)	Bits C 6,3 x 25 mm 4,0 X 0,8 / 5,5 x 1,0 / 6,5 x 1,2 PH 0 / PH 1 / PH 2 / PZ 1 / PZ 2			
		Артикул		EAN - код
	6	376 044 05	188	40 07157 52569 7
(8 x)	Bits C 6,3 x 25 mm 5,5 x 1,0 PH 1 / PH 2 / PZ 1 / PZ 2 Torx® 15 / Torx® 20 / Torx® 25			

Эргономичная усовершенствованная рукоятка с мягким покрытием

2-компонентная рукоятка для дополнительного комфорта



Сделано профессионалами для профессионалов
Т-образная

Прочный, долговечный сердечник для максимального крутящего момента

Отверстие для удобного хранения



без мягкого покрытия: точки экстремального давления



С мягким покрытием: точки пониженного давления

EAN- код на каждом товаре



Стержни из хром-ванадия и хром-молибден-ванадия

Превосходный крутящий момент, который превышает требования DIN и ISO на 100%



Хромированные стержни с матовой отделкой и черными наконечниками для точной посадки





303



mm					Артикул		EAN - код
2	100	100	2,0	6	303 203 60	58	40 07157 32248 7
2,5	100	100	2,5	6	303 253 60	60	40 07157 32250 0
3	150	100	3,0	6	303 035 60	66	40 07157 32252 4
4	150	100	4,0	6	303 045 60	74	40 07157 32254 8
5	150	100	5,0	6	303 055 60	84	40 07157 32256 2
6	150	100	6,0	6	303 065 60	100	40 07157 32258 6
8	200	100	8,0	6	303 087 60	155	40 07157 32262 3
10	200	100	10,0	6	303 107 60	198	40 07157 32264 7

304



mm				Артикул		EAN - код
5,5	230	100	6	304 558 60	113	40 07157 32266 1
6	125	100	6	304 064 60	94	40 07157 32296 8
6	230	100	6	304 068 60	167	40 07157 32268 5
7	230	100	6	304 078 60	138	40 07157 32270 8
8	125	100	6	304 084 60	109	40 07157 32300 2
8	230	100	6	304 088 60	141	40 07157 32272 2
8	350	100	6	304 089 60	177	40 07157 32274 6
9	230	100	6	304 098 60	142	40 07157 32276 0
10	125	100	6	304 104 60	124	40 07157 32304 0
10	230	100	6	304 108 60	166	40 07157 32278 4
10	350	100	6	304 109 60	213	40 07157 32280 7
11	230	100	6	304 118 60	174	40 07157 32282 1
12	230	100	6	304 128 60	175	40 07157 32284 5
13	125	100	6	304 134 60	138	40 07157 32310 1
13	230	100	6	304 138 60	177	40 07157 32286 9
13	350	100	6	304 139 60	225	40 07157 32288 3
17	230	100	6	304 178 60	202	40 07157 32292 0

308



Torx / [°]					Артикул		EAN - код
10	125	100	3,5	6	308 103 60	64	40 07157 50813 3
15	125	100	4,0	6	308 153 60	68	40 07157 50815 7
20	125	100	5,0	6	308 204 60	78	40 07157 32316 3
25	200	100	5,0	6	308 257 60	89	40 07157 32322 4
27	200	100	5,0	6	308 277 60	88	40 07157 32324 8
30	200	100	6,0	6	308 307 60	106	40 07157 32326 2
40	200	100	8,0	6	308 407 60	142	40 07157 32328 6
45	200	100	8,0	6	308 455 60	155	40 07157 32330 9



397



				Артикул		EAN - код
1/2"	125	100	6	397 127 60	150	40 07157 62897 8
1/4"	125	100	6	397 635 60	103	40 07157 62899 2
3/8"	125	100	6	397 952 60	135	40 07157 62901 2

338



				Артикул		EAN - код
1/4"	125	100	6	338 125 60	111	40 07157 32350 7



				Артикул		EAN - код
4,0 x 0,8	125 mm	4,0 mm	12	340 040 00	13	40 07157 31018 7
5,5 x 1,0	135 mm	5,5 mm	12	340 055 00	28	40 07157 31019 4
8,0 x 1,2	200 mm	8,0 mm	12	340 080 00	89	40 07157 26004 8



PZ						
1 + 2	135 mm	6,0 mm	12	341 120 00	35	40 07157 26006 2
3 + 4	200 mm	8,0 mm	12	341 340 00	74	40 07157 26008 6



PH						
1 + 2	135 mm	6,0 mm	12	342 120 00	35	40 07157 26010 9
3 + 4	200 mm	8,0 mm	12	342 340 00	94	40 07157 26012 3



PH						
6,0 + PH 2	135 mm	6,0 mm	12	343 260 00	35	40 07157 26014 7



Оптимальная точность формы
при производстве шестигранника

Более чем на 30%
увеличенная защита от коррозии,
благодаря защитному покрытию

Шестигранный Ключ

Тщательная обработка
гарантирует оптимальную
твердость и эластичность

Матовая
хромированная поверхность

Удлиненный стержень для
передачи максимального усилия

Шаровое окончание



348



Torx ^R			∅		Артикул		EAN - код
5	33	19	2,5	3	348 105 50	3	40 07157 53317 3
6	33	19	2,5	3	348 106 50	3	40 07157 53319 7
7	33	19	2,5	3	348 107 50	4	40 07157 53321 0
8	33	19	2,5	3	348 108 50	4	40 07157 53323 4
9	37	24	3,0	3	348 109 50	5	40 07157 53325 8
10	37	24	3,0	3	348 110 50	6	40 07157 53327 2
15	43	28	4,0	3	348 115 50	8	40 07157 53329 6
20	43	28	4,0	3	348 120 50	11	40 07157 53331 9



348



Torx ^R t.-Nr.	Артикул		EAN - код
	348 907 50	71	40 07157 60393 7
(7x) 348: Torx ^R 6 / Torx ^R 7 / Torx ^R 8 / Torx ^R 9 Torx ^R 10 / Torx ^R 15 / Torx ^R 20			

349



Torx Plus ^R			∅		Артикул		EAN - код
5 IP	33	19	2,5	3	349 105 50	3	40 07157 53333 3
6 IP	33	19	2,5	3	349 106 50	3	40 07157 53335 7
7 IP	33	19	2,5	3	349 107 50	4	40 07157 53337 1
8 IP	33	19	2,5	3	349 108 50	4	40 07157 53339 5
9 IP	37	24	3,0	3	349 109 50	5	40 07157 53341 8
10 IP	37	24	3,0	3	349 110 50	6	40 07157 53343 2
15 IP	43	28	4,0	3	349 115 50	8	40 07157 53345 6
20 IP	43	28	4,0	3	349 120 50	11	40 07157 53347 0

349



Torx Plus ^R t.-Nr.	Артикул		EAN - код
	349 907 50	71	40 07157 60395 1
(7x) 349: 6 IP / 7 IP / 8 IP / 9 IP / 10 IP / 15 IP / 20 IP			



345



				Артикул		EAN - код
1,5 mm	46,5	1,5	10	345 015 10	1	40 07157 64967 6
2,0 mm	52,0	2,0	10	345 020 10	2	40 07157 64969 0
2,5 mm	58,5	2,5	10	345 025 10	4	40 07157 64971 3
3,0 mm	66,0	3,0	10	345 030 10	5	40 07157 64973 7
3,5 mm	69,5	3,5	10	345 035 10	8	40 07157 64975 1
4,0 mm	74,0	4,0	10	345 040 10	10	40 07157 64977 5
4,5 mm	80,0	4,5	10	345 045 10	15	40 07157 64979 9
5,0 mm	85,0	5,0	10	345 050 10	18	40 07157 64981 2
6,0 mm	96,0	6,0	10	345 060 10	30	40 07157 64983 6
7,0 mm	102,0	7,0	10	345 070 10	43	40 07157 64985 0
8,0 mm	108,0	8,0	10	345 080 10	59	40 07157 64987 4
9,0 mm	114,0	9,0	10	345 090 10	79	40 07157 64989 8
10 mm	122,0	10,0	10	345 100 10	103	40 07157 64991 1
11 mm	129,0	11,0	5	345 110 10	131	40 07157 64993 5
12 mm	137,0	12,0	5	345 120 10	160	40 07157 64995 9
13 mm	145,0	13,0	5	345 130 10	215	40 07157 64997 3
14 mm	154,0	14,0	5	345 140 10	260	40 07157 64999 7
17 mm	177,0	17,0	5	345 170 10	430	40 07157 65001 6
19 mm	199,0	19,0	1	345 190 10	620	40 07157 65003 0
22 mm	222,0	22,0	1	345 220 10	950	40 07157 65005 4
24 mm	248,0	24,0	1	345 240 10	1250	40 07157 65007 8
27 mm	277,0	27,0	1	345 270 10	1740	40 07157 65009 2



345



		Артикул		EAN - код
	5	345 007 11	80	40 07157 65011 5

1,5 mm / 2,0 mm / 2,5 mm / 3,0 mm / 4,0 mm / 5,0 mm / 6,0 mm



346



				Артикул		EAN - код
1,5 mm	91,5	1,5	10	346 015 10	2	40 07157 65013 9
2,0 mm	102,0	2,0	10	346 020 10	4	40 07157 65015 3
2,5 mm	114,5	2,5	10	346 025 10	6	40 07157 65017 7
3,0 mm	129,0	3,0	10	346 030 10	9	40 07157 65019 1
4,0 mm	144,0	4,0	10	346 040 10	19	40 07157 65021 4
5,0 mm	165,0	5,0	10	346 050 10	33	40 07157 65023 8
6,0 mm	186,0	6,0	10	346 060 10	54	40 07157 65025 2
8,0 mm	208,0	8,0	10	346 080 10	105	40 07157 65027 6
10,0 mm	234,0	10,0	10	346 100 10	185	40 07157 65029 0



346



Артикул



EAN - код

346 009 11

430

40 07157 65031 3

1,5 mm / 2,0 mm / 2,5 mm / 3,0 mm / 4,0 mm

5,0 mm / 6,0 mm / 8,0 mm / 10,0 mm



348



Торх * Торх	Длина	Ø	Кол-во	Артикул	Кол-во	EAN - код
6	44,5	2,5	10	348 006 10	2	40 07157 65033 7
7	50,5	2,5	10	348 007 10	2	40 07157 65035 1
8	51,0	3,0	10	348 008 10	3	40 07157 65037 5
9	51,0	3,0	10	348 009 10	3	40 07157 65039 9
10	54,0	3,0	10	348 010 10	4	40 07157 65041 2
15	57,5	3,5	10	348 015 10	5	40 07157 65043 6
20	61,0	4,0	10	348 020 10	7	40 07157 65045 0
25	64,5	4,5	10	348 025 10	10	40 07157 65047 4
27	69,5	5,5	10	348 027 10	15	40 07157 65049 8
30	76,0	6,0	10	348 030 10	20	40 07157 65051 1
40	83,0	7,0	10	348 040 10	30	40 07157 65053 5
45	91,0	8,0	10	348 045 10	43	40 07157 65055 9
50	104,0	9,0	10	348 050 10	65	40 07157 65057 3



348



Артикул



EAN - код

5

348 888 11

160

40 07157 65059 7

Torx 9 / Торх 10 / Торх 15 / Торх 20 / Торх 25 / Торх 27 / Торх 30 / Торх 40



348



Артикул



EAN - код

5

348 080 11

270

40 07157 65061 0

Torx 9 / Торх 10 / Торх 15 / Торх 20 / Торх 25 / Торх 27 / Торх 30 / Торх 40



365



				Артикул		ЕАН - код
1,5 mm	91,5	1,5	10	365 015 10	2	40 07157 65063 4
2,0 mm	102,0	2,0	10	365 020 10	4	40 07157 65065 8
2,5 mm	114,5	2,5	10	365 025 10	6	40 07157 65067 2
3,0 mm	129,0	3,0	10	365 030 10	9	40 07157 65069 6
4,0 mm	144,0	4,0	10	365 040 10	19	40 07157 65071 9
5,0 mm	165,0	5,0	10	365 050 10	33	40 07157 65073 3
6,0 mm	186,0	6,0	10	365 060 10	54	40 07157 65077 1
8,0 mm	208,0	8,0	10	365 080 10	105	40 07157 65079 5
10,0 mm	234,0	10,0	10	365 100 10	185	40 07157 65081 8



365



		Артикул		ЕАН - код
1,5 mm / 2,0 mm / 2,5 mm / 3,0 mm / 4,0 mm 5,0 mm / 6,0 mm / 8,0 mm / 10,0 mm	5	365 009 11	430	40 07157 65083 2



375



				Артикул		ЕАН - код
.050" / 1/16" / 5/64" / 3/32" / 7/64" / 1/8" 9/64" / 5/32" / 3/16" / 7/32" / 1/4" / 5/16" / 3/8"			5	375 130 11	430	40 07157 65085 6



345



		Артикул		ЕАН - код
2,5 mm / 3,0 mm / 4,0 mm 5,0 mm / 6,0 mm / 8,0 mm	5	345 007 21	175	40 07157 65087 0



Держатели бит и переходники

038



Держатель бит магнитный E6,3



					Артикул		EAN - код
Держатель бит	47 mm	E 6,3	1/4"	6	038 109 90	17	40 07157 30850 4
Держатель бит	58 mm	E 6,3	1/4"	6	038 103 90	22	40 07157 30340 0
dto. в блистере				10	038 103 96	30	40 07157 10288 1
Держатель бит со стопорным кольцом	74 mm	E 6,3	1/4"	6	038 102 90	30	40 07157 30337 0
Держатель бит со стопорным кольцом	100 mm	E 6,3	1/4"	6	038 105 90	31	40 07157 50458 6
Держатель бит со стопорным кольцом	150 mm	E 6,3	1/4"	6	038 107 90	44	40 07157 50464 7
Держатель бит со стопорным кольцом	200 mm	E 6,3	1/4"	6	038 108 90	60	40 0715 763945 5

037



					Артикул		EAN - код
	51 mm	E 6,3	1/4"	6	037 103 90	25	40 07157 32146 6

059



					Артикул		EAN - код
	max. 79 mm	E 6,3	1/4"	6	059 103 90	74	40 07157 51897 2

018



					Артикул		EAN - код
	60 mm	A 5,5	1/4"	6	018 102 90	30	40 07157 30043 0

048



				Артикул		EAN - код
60 mm	G7	1/4"	6	048 102 80	31	40 07157 32452 8

058



				Артикул		EAN - код
98 mm	SDS	1/4"	6	058 102 90	58	40 07157 30978 5

097



				Артикул		EAN - код
50 mm	A 5,5	1/4"	6	097 011 10	15	40 07157 30479 7

097



				Артикул		EAN - код
50 mm	E 6,3	1/4"	6	097 013 10	15	40 07157 30481 0

097



				Артикул		EAN - код
50 mm	E 6,3	3/8"	6	097 020 10	23	40 07157 30489 6



4 IMPACT

С уникальным каскадом поглощения для лучшей защиты и самый долгий срок службы при самых тяжелых нагрузках!

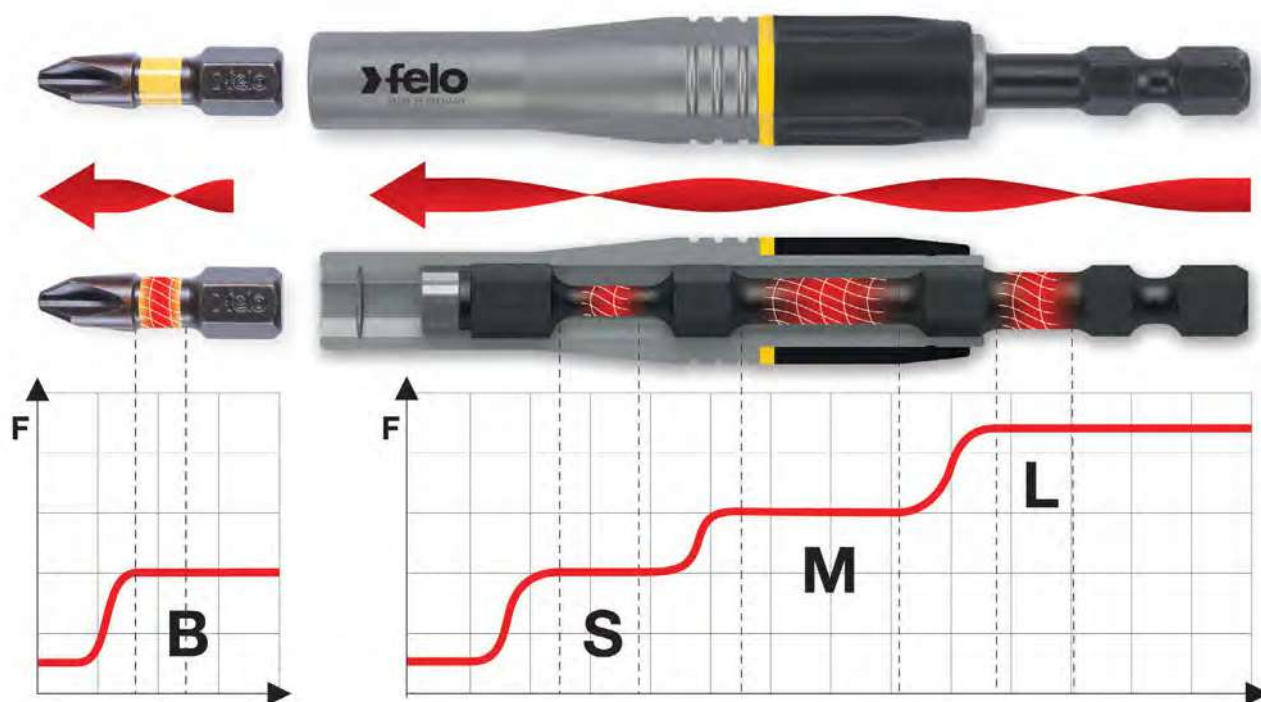

4 IMPACT

- S-M-L каскад поглощения для широкого диапазона крутящего момента (например, PH1 - PH3).
- Синхронизированные зоны вращения последовательно срабатывают для увеличения импульсов и поглощения пиков крутящего момента
- Дополнительная 4-я ступень поглощения при использовании бит Felo IMPACT.

- Специально разработан для ударных винтовертов.
- Со стопорным кольцом.

038
E 6,3



95 mm



E 6,3



6

Артикул

038 295 90



43

EAN - код

40 07157 63337 8

038
E 6,3



95 mm



E 6,3



6

Артикул

038 295 94



53

EAN - код

40 07157 63077 3

TORSION

Высокопроизводительная бита

- поглощает пики крутящего момента
- существенно увеличивает срок службы инструмента
- уменьшает контактное давление

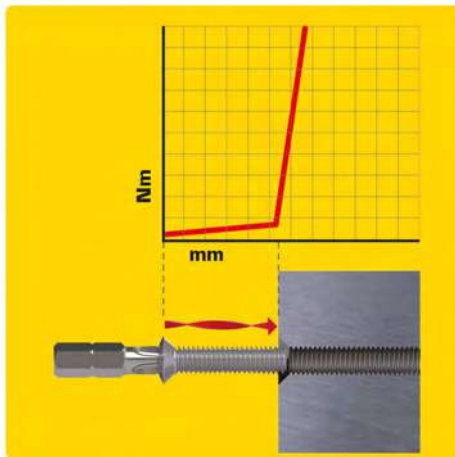

Жесткое винтовое соединение

Проблема:

Внезапный пик крутящего момента, когда головка винта ударяет в поверхность заготовки и может повредить винт и бит.

Решение:

Биты Felo TORSION поглощают пики крутящего момента и эффективно предотвращают повреждение.

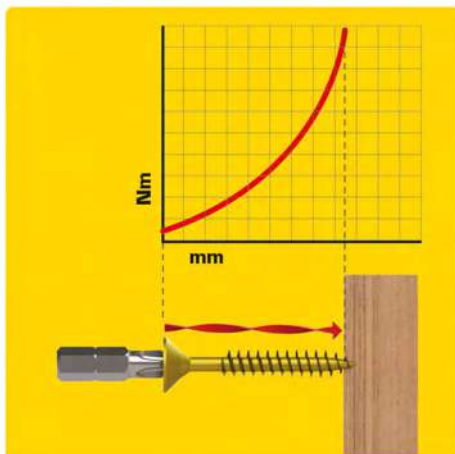

Плавное винтовое соединение

Плавное винтовое соединение например, при завинчивании в древесину, при которых крутящий момент непрерывно растет.

Дополнительное преимущество:

Особо износостойкие профили увеличивают срок службы битов

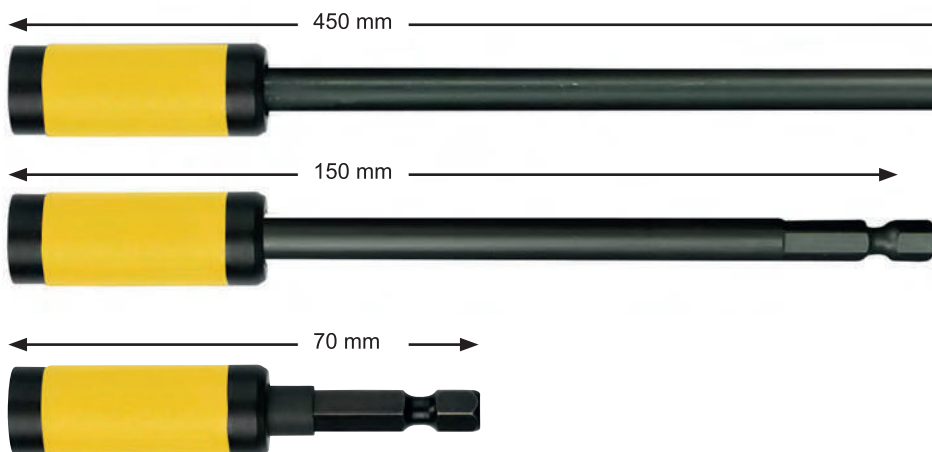

Подпружиненная подвижная втулка автоматического держателя Felo Star содержит сильный круглый магнит, который плотно прижимает головку винта к наконечнику биты, исключая необходимость ручного закрепления винта.

Это обеспечивает дополнительную безопасность и отличные результаты работы. Высококачественные материалы и точная обработка гарантируют долгий срок службы инструмента.

038



Felo Star	←→	⊕	⬡	📦	Артикул	📦	EAN - код
	70 mm	E 6,3	1/4"	6	038 165 90	31	40 07157 50799 0
	70 mm	E 6,3	1/4"	6	038 165 94	37	40 07157 52673 1
	150 mm	E 6,3	1/4"	6	038 169 90	55	40 07157 51979 5
	450 mm	E 6,3	1/4"	1	038 170 90	128	40 07157 60367 8

Биты Industrial



020 C6,3



				Артикул		EAN - код
3,0 x 0,5	25 mm	C 6,3 1/4"	10	020 300 10	4	40 07157 30066 9
3,5 x 0,6	25 mm	C 6,3 1/4"	10	020 310 10	4	40 07157 30070 6
4,0 x 0,8	25 mm	C 6,3 1/4"	10	020 410 10	5	40 07157 30079 9
5,5 x 1,0	25 mm	C 6,3 1/4"	10	020 520 10	5	40 07157 30105 5
6,5 x 1,2	25 mm	C 6,3 1/4"	10	020 610 10	6	40 07157 30119 2
8,0 x 1,2	25 mm	C 6,3 1/4"	10	020 800 10	7	40 07157 30918 1

021 C6,3



PZ				Артикул		EAN - код
0	25 mm	C 6,3 1/4"	10	021 000 10	4	40 07157 24025 5
1	25 mm	C 6,3 1/4"	10	021 010 10	5	40 07157 30159 8
1 (VE 100)	25 mm	C 6,3 1/4"	100	021 010 17	500	40 07157 30925 9
2	25 mm	C 6,3 1/4"	10	021 020 10	5	40 07157 30169 7
2 (VE 100)	25 mm	C 6,3 1/4"	100	021 020 17	520	40 07157 30928 0
3	25 mm	C 6,3 1/4"	10	021 030 10	6	40 07157 30180 2
3 (VE 100)	25 mm	C 6,3 1/4"	100	021 030 17	540	40 07157 31353 9
4	32 mm	C 6,3 1/4"	10	021 042 10	12	40 07157 30190 1

022 C6,3



PH				Артикул		EAN - код
0	25 mm	C 6,3 1/4"	10	022 000 10	4	40 07157 30937 2
1	25 mm	C 6,3 1/4"	10	022 010 10	5	40 07157 30193 2
1 (VE 100)	25 mm	C 6,3 1/4"	100	022 010 17	470	40 07157 30940 2
2	25 mm	C 6,3 1/4"	10	022 020 10	5	40 07157 30205 2
2 (VE 100)	25 mm	C 6,3 1/4"	100	022 020 17	510	40 07157 30943 3
3	25 mm	C 6,3 1/4"	10	022 030 10	6	40 07157 30218 2
3 (VE 100)	25 mm	C 6,3 1/4"	100	022 030 17	560	40 07157 31351 5
4	32 mm	C 6,3 1/4"	10	022 042 10	11	40 07157 30229 8

022 C6,3



extra slim



PH				Артикул		EAN - код
2	25 mm	C 6,3 1/4"	10	022 002 10	4	40 07157 10238 6

024 C6,3



mm				Артикул		EAN - код
2	25 mm	C 6,3 1/4"	10	024 200 10	5	40 07157 30952 5
2,5	25 mm	C 6,3 1/4"	10	024 250 10	5	40 07157 30253 3
3	25 mm	C 6,3 1/4"	10	024 300 10	5	40 07157 30255 7
4	25 mm	C 6,3 1/4"	10	024 400 10	5	40 07157 30257 1
5	25 mm	C 6,3 1/4"	10	024 500 10	6	40 07157 30259 5
5,5	25 mm	C 6,3 1/4"	10	024 550 10	6	40 07157 62319 5
6	25 mm	C 6,3 1/4"	10	024 600 10	7	40 07157 30261 8
8	25 mm	C 6,3 1/4"	10	024 800 10	9	40 07157 30263 2
3/32"	25 mm	C 6,3 1/4"	10	024 238 10	8	40 07157 64871 6
3/16"	25 mm	C 6,3 1/4"	10	024 476 20	8	40 07157 64873 0
1/4"	25 mm	C 6,3 1/4"	10	024 635 20	8	40 07157 64875 4

025 C6,3



SQ				Артикул		EAN - код
0 (1,75 mm)	25 mm	C 6,3 1/4"	10	025 000 10	4	40 07157 50350 3
1 (2,30 mm)	25 mm	C 6,3 1/4"	10	025 100 10	4	40 07157 50352 7
2 (2,80 mm)	25 mm	C 6,3 1/4"	10	025 200 10	5	40 07157 50354 1
3 (3,30 mm)	25 mm	C 6,3 1/4"	10	025 300 10	5	40 07157 50356 5

026 C6,3



Torx ^Æ				Артикул		EAN - код
5	25 mm	C 6,3 1/4"	10	026 050 10	4	40 07157 50779 2
6	25 mm	C 6,3 1/4"	10	026 060 10	4	40 07157 30953 2
7	25 mm	C 6,3 1/4"	10	026 070 10	4	40 07157 30954 9
8	25 mm	C 6,3 1/4"	10	026 080 10	4	40 07157 30955 6
9	25 mm	C 6,3 1/4"	10	026 090 10	4	40 07157 30956 3
10	25 mm	C 6,3 1/4"	10	026 100 10	5	40 07157 30957 0
10 (VE 100)	25 mm	C 6,3 1/4"	100	026 100 17	460	40 07157 31561 8
15	25 mm	C 6,3 1/4"	10	026 150 10	5	40 07157 30959 4
15 (VE 100)	25 mm	C 6,3 1/4"	100	026 150 17	480	40 07157 31563 2
20	25 mm	C 6,3 1/4"	10	026 200 10	5	40 07157 30961 7
20 (VE 100)	25 mm	C 6,3 1/4"	100	026 200 17	510	40 07157 31565 6
25	25 mm	C 6,3 1/4"	10	026 250 10	5	40 07157 30963 1
25 (VE 100)	25 mm	C 6,3 1/4"	100	026 250 17	530	40 07157 31567 0
27	25 mm	C 6,3 1/4"	10	026 270 10	5	40 07157 30965 5
30	25 mm	C 6,3 1/4"	10	026 300 10	6	40 07157 30967 9
30 (VE 100)	25 mm	C 6,3 1/4"	100	026 300 17	620	40 07157 31569 4
40	25 mm	C 6,3 1/4"	10	026 400 10	6	40 07157 30969 3
40 (VE 100)	25 mm	C 6,3 1/4"	100	026 400 17	620	40 07157 31571 7
45	25 mm	C 6,3 1/4"	10	026 450 10	7	40 07157 32076 6
50	26 mm	C 6,3 1/4"	10	026 500 10	8	40 07157 32450 4
50	32 mm	C 6,3 1/4"	10	026 501 10	10	40 07157 51399 1

027 C6,3



Torx ^Æ TR				Артикул		EAN - код
7 H	25 mm	C 6,3 1/4"	10	027 070 10	4	40 07157 50771 6
8 H	25 mm	C 6,3 1/4"	10	027 080 10	4	40 07157 50773 0
9 H	25 mm	C 6,3 1/4"	10	027 090 10	4	40 07157 50775 4
10 H	25 mm	C 6,3 1/4"	10	027 100 10	5	40 07157 30971 6
15 H	25 mm	C 6,3 1/4"	10	027 150 10	5	40 07157 30972 3
20 H	25 mm	C 6,3 1/4"	10	027 200 10	5	40 07157 30973 0
25 H	25 mm	C 6,3 1/4"	10	027 250 10	5	40 07157 30974 7
27 H	25 mm	C 6,3 1/4"	10	027 270 10	5	40 07157 30975 4
30 H	25 mm	C 6,3 1/4"	10	027 300 10	6	40 07157 30976 1
40 H	25 mm	C 6,3 1/4"	10	027 400 10	6	40 07157 30977 8

023 C6,3



Torx Plus ^Æ				Артикул		EAN - код
6 IP	25 mm	C 6,3 1/4"	10	023 060 10	4	40 07157 51341 0
7 IP	25 mm	C 6,3 1/4"	10	023 070 10	4	40 07157 51343 4
8 IP	25 mm	C 6,3 1/4"	10	023 080 10	4	40 07157 51345 8
9 IP	25 mm	C 6,3 1/4"	10	023 090 10	4	40 07157 51347 2
10 IP	25 mm	C 6,3 1/4"	10	023 100 10	5	40 07157 51349 6
15 IP	25 mm	C 6,3 1/4"	10	023 150 10	5	40 07157 51351 9
20 IP	25 mm	C 6,3 1/4"	10	023 200 10	5	40 07157 51353 3
25 IP	25 mm	C 6,3 1/4"	10	023 250 10	5	40 07157 51355 7
27 IP	25 mm	C 6,3 1/4"	10	023 270 10	6	40 07157 51357 1
30 IP	25 mm	C 6,3 1/4"	10	023 300 10	6	40 07157 51359 5
40 IP	25 mm	C 6,3 1/4"	10	023 400 10	6	40 07157 51361 8



028 C6,3



Clutch				Артикул		EAN - код
5/32"	25 mm	C 6,3 1/4"	10	028 930 10	5	40 07157 52271 9
1/4"	25 mm	C 6,3 1/4"	10	028 940 10	6	40 07157 52273 3

028 C6,3



XZN				Артикул		EAN - код
M 4	25 mm	C 6,3 1/4"	10	028 040 10	5	40 07157 50360 2
M 5	25 mm	C 6,3 1/4"	10	028 050 10	5	40 07157 50362 6
M 6	25 mm	C 6,3 1/4"	10	028 060 10	6	40 07157 50364 0
M 8	25 mm	C 6,3 1/4"	10	028 080 10	6	40 07157 50366 4
M10	25 mm	C 6,3 1/4"	10	028 100 10	8	40 07157 50368 8

029 C6,3



TS				Артикул		EAN - код
0	25 mm	C 6,3 1/4"	10	029 000 10	5	40 07157 50370 1
1	25 mm	C 6,3 1/4"	10	029 010 10	6	40 07157 50372 5
2	25 mm	C 6,3 1/4"	10	029 020 10	5	40 07157 50374 9
3	25 mm	C 6,3 1/4"	10	029 030 10	5	40 07157 50376 3
4	25 mm	C 6,3 1/4"	10	029 040 10	5	40 07157 50378 7
5	25 mm	C 6,3 1/4"	10	029 050 10	5	40 07157 50380 0
6	25 mm	C 6,3 1/4"	10	029 060 10	5	40 07157 50382 4
8	25 mm	C 6,3 1/4"	10	029 080 10	6	40 07157 50536 1
10	25 mm	C 6,3 1/4"	10	029 100 10	6	40 07157 50819 5

029 C6,3



Tri-Wing				Артикул		EAN - код
1	25 mm	C 6,3 1/4"	10	029 510 10	5	40 07157 52255 9
2	25 mm	C 6,3 1/4"	10	029 520 10	5	40 07157 52257 3
3	25 mm	C 6,3 1/4"	10	029 530 10	5	40 07157 52259 7
4	25 mm	C 6,3 1/4"	10	029 540 10	5	40 07157 52261 0
5	25 mm	C 6,3 1/4"	10	029 550 10	5	40 07157 52263 4

020 C6,3



Spanner				Артикул		EAN - код
6	25 mm	C 6,3 1/4"	10	020 906 10	5	40 07157 52265 8
8	25 mm	C 6,3 1/4"	10	020 908 10	5	40 07157 52267 2
10	25 mm	C 6,3 1/4"	10	020 910 10	5	40 07157 52269 6

030 E6,3



				Артикул		EAN - код
3,0 x 0,5	50 mm	E 6,3 1/4"	10	030 305 10	8	40 07157 30772 9
3,5 x 0,6	50 mm	E 6,3 1/4"	10	030 315 10	8	40 07157 30275 5
4,0 x 0,8	50 mm	E 6,3 1/4"	10	030 415 10	9	40 07157 30277 9
5,5 x 1,0	50 mm	E 6,3 1/4"	10	030 525 10	10	40 07157 30285 4
6,5 x 1,2	50 mm	E 6,3 1/4"	10	030 615 10	12	40 07157 30290 8
8,0 x 1,6	50 mm	E 6,3 1/4"	10	030 815 10	14	40 07157 30294 6
10,0 x 1,6	50 mm	E 6,3 1/4"	10	030 105 10	17	40 07157 30272 4

031 E6,3



PZ				Артикул		EAN - код
1	50 mm	E 6,3 1/4"	10	031 015 10	9	40 07157 30309 7
2	50 mm	E 6,3 1/4"	10	031 025 10	11	40 07157 30312 7
3	50 mm	E 6,3 1/4"	10	031 035 10	11	40 07157 30315 8



032 E6,3



PH				Артикул		EAN - код
0	50 mm	E 6,3 1/4"	10	032 005 10	8	40 07157 51015 0
1	50 mm	E 6,3 1/4"	10	032 015 10	9	40 07157 30317 2
2	50 mm	E 6,3 1/4"	10	032 025 10	11	40 07157 30320 2
2 (VE 100)	50 mm	E 6,3 1/4"	100	032 025 17	1100	40 07157 31956 2
3	50 mm	E 6,3 1/4"	10	032 035 10	12	40 07157 30323 3

033 E6,3



Torx Plus ^R				Артикул		EAN - код
10 IP	50 mm	E 6,3 1/4"	10	033 105 10	8	40 07157 51363 2
15 IP	50 mm	E 6,3 1/4"	10	033 155 10	9	40 07157 51365 6
20 IP	50 mm	E 6,3 1/4"	10	033 205 10	9	40 07157 51367 0
25 IP	50 mm	E 6,3 1/4"	10	033 255 10	10	40 07157 51369 4
30 IP	50 mm	E 6,3 1/4"	10	033 305 10	11	40 07157 51371 7

034 E6,3



mm				Артикул		EAN - код
2,5	50 mm	E 6,3 1/4"	10	034 255 10	11	40 07157 30325 7
3,0	50 mm	E 6,3 1/4"	10	034 305 10	11	40 07157 30327 1
4,0	50 mm	E 6,3 1/4"	10	034 405 10	12	40 07157 30329 5
5,0	50 mm	E 6,3 1/4"	10	034 505 10	12	40 07157 30331 8
6,0	50 mm	E 6,3 1/4"	10	034 605 10	13	40 07157 30333 2
8,0	50 mm	E 6,3 1/4"	10	034 805 10	17	40 07157 31878 7

035 E6,3



SQ				Артикул		EAN - код
1 (2,30 mm)	50 mm	E 6,3 1/4"	10	035 105 10	11	40 07157 63601 0
2 (2,80 mm)	50 mm	E 6,3 1/4"	10	035 205 10	11	40 07157 63603 4
3 (3,30 mm)	50 mm	E 6,3 1/4"	10	035 305 10	12	40 07157 63605 8

036 E6,3



Torx ^R				Артикул		EAN - код
5	50 mm	E 6,3 1/4"	10	036 055 10	7	40 07157 50973 4
6	50 mm	E 6,3 1/4"	10	036 065 10	7	40 07157 51375 5
7	50 mm	E 6,3 1/4"	10	036 075 10	7	40 07157 51377 9
8	50 mm	E 6,3 1/4"	10	036 085 10	8	40 07157 30834 4
9	50 mm	E 6,3 1/4"	10	036 095 10	8	40 07157 30835 1
10	50 mm	E 6,3 1/4"	10	036 105 10	9	40 07157 30836 8
15	50 mm	E 6,3 1/4"	10	036 155 10	8	40 07157 24026 2
20	50 mm	E 6,3 1/4"	10	036 205 10	9	40 07157 30839 9
25	50 mm	E 6,3 1/4"	10	036 255 10	9	40 07157 30841 2
27	50 mm	E 6,3 1/4"	10	036 275 10	9	40 07157 30843 6
30	50 mm	E 6,3 1/4"	10	036 305 10	11	40 07157 30845 0
40	50 mm	E 6,3 1/4"	10	036 405 10	12	40 07157 30847 4



030 E6,3



				Артикул		EAN - код
3,0 x 0,5	73 mm	E 6,3 1/4"	5	030 307 10	9	40 07157 30274 8
3,5 x 0,6	73 mm	E 6,3 1/4"	5	030 317 10	11	40 07157 30773 6
4,0 x 0,8	73 mm	E 6,3 1/4"	5	030 417 10	11	40 07157 30279 3
5,5 x 1,0	73 mm	E 6,3 1/4"	5	030 527 10	14	40 07157 30787 3
6,5 x 1,2	73 mm	E 6,3 1/4"	5	030 617 10	17	40 07157 30794 1

031 E6,3



PZ				Артикул		EAN - код
1	73 mm	E 6,3 1/4"	5	031 017 10	12	40 07157 30311 0
2	73 mm	E 6,3 1/4"	5	031 027 10	16	40 07157 30314 1
3	73 mm	E 6,3 1/4"	5	031 037 10	18	40 07157 30815 3

032 E6,3



PH				Артикул		EAN - код
1	73 mm	E 6,3 1/4"	5	032 017 10	12	40 07157 30319 6
2	73 mm	E 6,3 1/4"	5	032 027 10	16	40 07157 30322 6
3	73 mm	E 6,3 1/4"	5	032 037 10	18	40 07157 30833 7

035 E6,3



SQ				Артикул		EAN - код
0 (1,75 mm)	73 mm	E 6,3 1/4"	5	035 007 10	17	40 07157 31520 5
1 (2,30 mm)	73 mm	E 6,3 1/4"	5	035 017 10	17	40 07157 31522 9
2 (2,80 mm)	73 mm	E 6,3 1/4"	5	035 027 10	18	40 07157 31524 3
3 (3,30 mm)	73 mm	E 6,3 1/4"	5	035 037 10	18	40 07157 31526 7

036 E6,3



Torx ^R				Артикул		EAN - код
10	73 mm	E 6,3 1/4"	3	036 107 10	10	40 07157 30837 5
15	73 mm	E 6,3 1/4"	3	036 157 10	11	40 07157 30838 2
20	73 mm	E 6,3 1/4"	3	036 207 10	12	40 07157 30840 5
25	73 mm	E 6,3 1/4"	3	036 257 10	13	40 07157 30842 9
27	73 mm	E 6,3 1/4"	3	036 277 10	14	40 07157 30844 3
30	73 mm	E 6,3 1/4"	3	036 307 10	17	40 07157 30846 7
40	73 mm	E 6,3 1/4"	3	036 407 10	19	40 07157 30848 1

031 E6,3



PlusMinus				Артикул		EAN - код
Z 1	73 mm	E 6,3 1/4"	5	031 101 10	12	40 07157 51883 5
Z 2	73 mm	E 6,3 1/4"	5	031 202 10	16	40 07157 51885 9

032 E6,3



PlusMinus				Артикул		EAN - код
H 1	73 mm	E 6,3 1/4м	5	032 101 10	12	40 07157 51879 8
H 2	73 mm	E 6,3 1/4м	5	032 202 10	16	40 07157 51881 1



036 E6,3



Torx ^R				Артикул		EAN - код
T 10	100 mm	E 6,3 1/4"	3	036 109 10	14	40 07157 64907 2
T 15	100 mm	E 6,3 1/4"	3	036 159 10	15	40 07157 64909 6
T 20	100 mm	E 6,3 1/4"	3	036 209 10	17	40 07157 51255 0
T 25	100 mm	E 6,3 1/4"	3	036 259 10	18	40 07157 51253 6
T 30	100 mm	E 6,3 1/4"	3	036 309 10	23	40 07157 51407 3
T 40	100 mm	E 6,3 1/4"	3	036 409 10	25	40 07157 51409 7

030 E6,3



				Артикул		EAN - код
4,0 x 0,8	100 mm	E 6,3 1/4"	3	030 418 10	14	40 07157 30778 1
5,5 x 1,0	100 mm	E 6,3 1/4"	3	030 528 10	19	40 07157 30788 0
6,5 x 1,2	100 mm	E 6,3 1/4"	3	030 618 10	24	40 07157 30795 8
8,0 x 1,2	100 mm	E 6,3 1/4"	3	030 818 10	33	40 07157 30800 9

031 E6,3



PZ				Артикул		EAN - код
1	100 mm	E 6,3 1/4"	3	031 018 10	15	40 07157 30805 4
2	100 mm	E 6,3 1/4"	3	031 028 10	22	40 07157 30810 8
3	100 mm	E 6,3 1/4"	3	031 038 10	25	40 07157 30816 0

032 E6,3



PH				Артикул		EAN - код
1	100 mm	E 6,3 1/4"	3	032 018 10	15	40 07157 30822 1
2	100 mm	E 6,3 1/4"	3	032 028 10	22	40 07157 30828 3

031 E6,3



PZ				Артикул		EAN - код
1	150 mm	E 6,3 1/4"	3	031 019 10	22	40 07157 30752 1
2	150 mm	E 6,3 1/4"	3	031 029 10	33	40 07157 30812 2
3	150 mm	E 6,3 1/4"	3	031 039 10	39	40 07157 30817 7

032 E6,3



PH				Артикул		EAN - код
1	150 mm	E 6,3 1/4"	3	032 019 10	22	40 07157 30823 8
2	150 mm	E 6,3 1/4"	3	032 029 10	33	40 07157 30830 6

036 E6,3



Torx ^R				Артикул		EAN - код
10	150 mm	E 6,3 1/4"	3	036 100 10	22	40 07157 63839 7
15	150 mm	E 6,3 1/4"	3	036 150 10	22	40 07157 63565 5
20	150 mm	E 6,3 1/4"	3	036 200 10	33	40 07157 63567 9
25	150 mm	E 6,3 1/4"	3	036 250 10	39	40 07157 63569 3
30	150 mm	E 6,3 1/4"	3	036 300 10	42	40 07157 63571 6

Биты Impact



021 C6,3



IMPACT PZ				Артикул		EAN - код
1	25 mm	C 6,3 1/4"	5	021 010 40	3	40 07157 62939 5
2	25 mm	C 6,3 1/4"	5	021 020 40	4	40 07157 62941 8
3	25 mm	C 6,3 1/4"	5	021 030 40	5	40 07157 62943 2

022 C6,3



IMPACT PH				Артикул		EAN - код
1	25 mm	C 6,3 1/4"	5	022 010 40	3	40 07157 62933 3
2	25 mm	C 6,3 1/4"	5	022 020 40	4	40 07157 62935 7
3	25 mm	C 6,3 1/4"	5	022 030 40	5	40 07157 62937 1

024 C6,3



IMPACT HEX				Артикул		EAN - код
3,0 mm	25 mm	C 6,3 1/4"	5	024 300 40	5	40 07157 64877 8
4,0 mm	25 mm	C 6,3 1/4"	5	024 400 40	5	40 07157 64879 2
5,0 mm	25 mm	C 6,3 1/4"	5	024 500 40	6	40 07157 64881 5
6,0 mm	25 mm	C 6,3 1/4"	5	024 600 40	7	40 07157 64883 9

025 C6,3



IMPACT SQ				Артикул		EAN - код
SQ 1	25 mm	C 6,3 1/4"	5	025 100 40	4	40 07157 64885 3
SQ 2	25 mm	C 6,3 1/4"	5	025 200 40	5	40 07157 64887 7
SQ 3	25 mm	C 6,3 1/4"	5	025 300 40	5	40 07157 64889 1

026 C6,3



IMPACT Torx [®]				Артикул		EAN - код
10	25 mm	C 6,3 1/4"	5	026 100 40	3	40 07157 62945 6
15	25 mm	C 6,3 1/4"	5	026 150 40	3	40 07157 62947 0
20	25 mm	C 6,3 1/4"	5	026 200 40	4	40 07157 62949 4
25	25 mm	C 6,3 1/4"	5	026 250 40	4	40 07157 62951 7
27	25 mm	C 6,3 1/4"	5	026 270 40	5	40 07157 64891 4
30	25 mm	C 6,3 1/4"	5	026 300 40	5	40 07157 62953 1
40	25 mm	C 6,3 1/4"	5	026 400 40	5	40 07157 62955 5

031 E6,3



IMPACT PZ				Артикул		EAN - код
1	50 mm	E 6,3 1/4"	5	031 015 40	6	40 07157 62963 0
2	50 mm	E 6,3 1/4"	5	031 025 40	7	40 07157 62965 4
3	50 mm	E 6,3 1/4"	5	031 035 40	8	40 07157 62967 8

032 E6,3



IMPACT PH				Артикул		EAN - код
1	50 mm	E 6,3 1/4"	5	032 015 40	6	40 07157 62957 9
2	50 mm	E 6,3 1/4"	5	032 025 40	7	40 07157 62959 3
3	50 mm	E 6,3 1/4"	5	032 035 40	8	40 07157 62961 6

034
E6,3



IMPACT HEX				Артикул		EAN - код
3,0 mm	50 mm	E 6,3 1/4"	5	034 305 40	8	40 07157 64893 8
4,0 mm	50 mm	E 6,3 1/4"	5	034 405 40	8	40 07157 64895 2
5,0 mm	50 mm	E 6,3 1/4"	5	034 505 40	9	40 07157 64897 6
6,0 mm	50 mm	E 6,3 1/4"	5	034 605 40	10	40 07157 64899 0

035
E6,3



IMPACT SQ				Артикул		EAN - код
SQ 1	50 mm	E 6,3 1/4"	5	035 105 40	8	40 07157 64901 0
SQ 2	50 mm	E 6,3 1/4"	5	035 205 40	8	40 07157 64903 4
SQ 3	50 mm	E 6,3 1/4"	5	035 305 40	8	40 07157 64905 8

036
E6,3



IMPACT Torx				Артикул		EAN - код
10	50 mm	E 6,3 1/4"	5	036 105 40	8	40 07157 62969 2
15	50 mm	E 6,3 1/4"	5	036 155 40	8	40 07157 62971 5
20	50 mm	E 6,3 1/4"	5	036 205 40	8	40 07157 62973 9
25	50 mm	E 6,3 1/4"	5	036 255 40	8	40 07157 62975 3
27	50 mm	E 6,3 1/4"	5	036 275 40	8	40 07157 64911 9
30	50 mm	E 6,3 1/4"	5	036 305 40	9	40 07157 62977 7
40	50 mm	E 6,3 1/4"	5	036 405 40	9	40 07157 62979 1

Биты Diamond Алмазное напыление



Diamond
coated



021
C6,3



PZ				Артикул		EAN - код
1	25 mm	C 6,3 1/4"	10	021 010 80	4	40 07157 50661 0
2	25 mm	C 6,3 1/4"	10	021 020 80	5	40 07157 50663 4
3	25 mm	C 6,3 1/4"	10	021 030 80	5	40 07157 50665 8

022
C6,3



PH				Артикул		EAN - код
1	25 mm	C 6,3 1/4"	10	022 010 80	4	40 07157 50655 9
2	25 mm	C 6,3 1/4"	10	022 020 80	5	40 07157 50657 3
3	25 mm	C 6,3 1/4"	10	022 030 80	5	40 07157 50659 7

Биты TiN

TiN (>90 HRC)

SX 75 (>60 HRC)



021 C6,3 TiN



PZ				Артикул		EAN - код
1	25 mm	C 6,3 1/4"	10	021 010 70	5	40 07157 10313 0
1 (VE 100)	25 mm	C 6,3 1/4"	100	021 010 77	500	40 07157 53415 6
2	25 mm	C 6,3 1/4"	10	021 020 70	5	40 07157 10314 7
2 (VE 100)	25 mm	C 6,3 1/4"	100	021 020 76	500	40 07157 53417 0
3	25 mm	C 6,3 1/4"	10	021 030 70	5	40 07157 10315 4
3 (VE 100)	25 mm	C 6,3 1/4"	100	021 030 77	500	40 07157 53419 4

022 C6,3 TiN



PH				Артикул		EAN - код
1	25 mm	C 6,3 1/4"	10	022 010 70	5	40 07157 10316 1
1 (VE 100)	25 mm	C 6,3 1/4"	100	022 010 77	500	40 07157 53421 7
2	25 mm	C 6,3 1/4"	10	022 020 70	5	40 07157 10317 8
2 (VE 100)	25 mm	C 6,3 1/4"	100	022 020 77	500	40 07157 52339 6
3	25 mm	C 6,3 1/4"	10	022 030 70	5	40 07157 10318 5
3 (VE 100)	25 mm	C 6,3 1/4"	100	022 030 77	500	40 07157 53423 1

022 C6,3 TiN



extra slim



PH				Артикул		EAN - код
2	25 mm	C 6,3 1/4"	10	022 002 70	5	40 07157 52471 3

026 C6,3 TiN



Torx *				Артикул		EAN - код
10	25 mm	C 6,3 1/4"	10	026 100 70	5	40 07157 50220 9
15	25 mm	C 6,3 1/4"	10	026 150 70	5	40 07157 50222 3
15 (VE 100)	25 mm	C 6,3 1/4"	100	026 150 77	500	40 07157 52321 1
20	25 mm	C 6,3 1/4"	10	026 200 70	5	40 07157 50224 7
20 (VE 100)	25 mm	C 6,3 1/4"	100	026 200 77	500	40 07157 52323 5
25	25 mm	C 6,3 1/4"	10	026 250 70	5	40 07157 50226 1
25 (VE 100)	25 mm	C 6,3 1/4"	100	026 250 77	500	40 07157 52325 9
27	25 mm	C 6,3 1/4"	10	026 270 70	5	40 07157 50228 5
30	25 mm	C 6,3 1/4"	10	026 300 70	6	40 07157 50230 8
40	25 mm	C 6,3 1/4"	10	026 400 70	6	40 07157 50232 2
45	25 mm	C 6,3 1/4"	10	026 450 70	7	40 07157 50234 6

031 E6,3 TiN



PZ				Артикул		EAN - код
1	50 mm	E 6,3 1/4"	10	031 015 70	9	40 07157 30801 6
2	50 mm	E 6,3 1/4"	10	031 025 70	11	40 07157 30806 1
3	50 mm	E 6,3 1/4"	10	031 035 70	12	40 07157 30813 9

032 E6,3 TiN



PH				Артикул		EAN - код
1	50 mm	E 6,3 1/4"	10	032 015 70	9	40 07157 30818 4
2	50 mm	E 6,3 1/4"	10	032 025 70	11	40 07157 30824 5
3	50 mm	E 6,3 1/4"	10	032 035 70	12	40 07157 30831 3

Специальные биты и адаптеры

029
C 6,3



LocTec®						
15- LID	25	C 6,3	1/4"	10	029 300 10	5 40 07157 60379 1
20- LID	25	C 6,3	1/4"	10	029 400 10	5 40 07157 60381 4
25- LID	25	C 6,3	1/4"	10	029 500 10	6 40 07157 60383 8
30- LID	25	C 6,3	1/4"	10	029 600 10	6 40 07157 60385 2

079
C 8



LocTec®						
45- LID	30	C 8	5/16"	10	079 080 10	11 40 07157 60389 0
50- LID	30	C 8	5/16"	10	079 100 10	11 40 07157 60387 6

Вкручивать

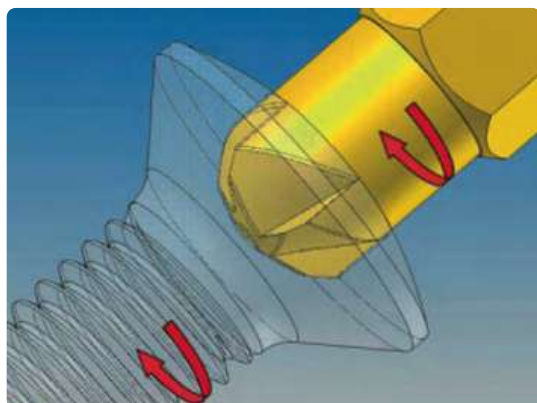

Винт LocTec® просто закручивается специальной битой. Дополнительные меры фиксации не требуются.

Попытка выкручивания

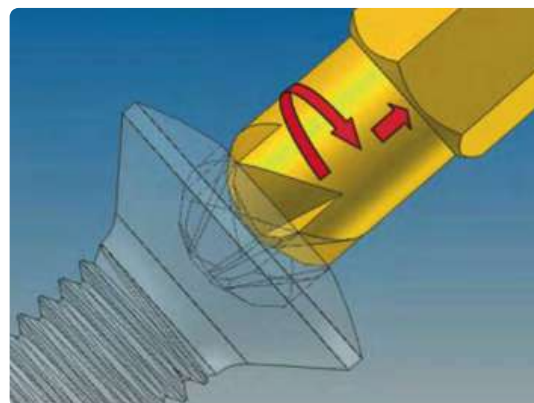

Специальная геометрия гарантирует, что любая попытка выкрутить винт даже со специальной битой будет неудачной, так как бита будет выскакивать из винта.

Для получения дополнительной информации посетите

www.arnold-umformtechnik.de

039
E6,3



mm				Артикул		EAN - код
5	66 mm	E 6,3 1/4"	5	039 050 10	28	40 07157 50404 3
6	66 mm	E 6,3 1/4"	5	039 060 10	27	40 07157 50406 7
7	66 mm	E 6,3 1/4"	5	039 070 10	26	40 07157 51373 1
8	66 mm	E 6,3 1/4"	5	039 080 10	31	40 07157 50408 1
9	66 mm	E 6,3 1/4"	5	039 090 10	33	40 07157 53245 9
10	66 mm	E 6,3 1/4"	5	039 100 10	36	40 07157 50410 4
11	66 mm	E 6,3 1/4"	5	039 110 10	36	40 07157 53247 3
12	66 mm	E 6,3 1/4"	5	039 120 10	39	40 07157 53249 7
13	66 mm	E 6,3 1/4"	5	039 130 10	54	40 07157 50412 8

039
E6,3



				Артикул		EAN - код
5/16"	66 mm	E 6,3 1/4"	5	039 516 10	31	40 07157 50414 2
3/8"	66 mm	E 6,3 1/4"	5	039 038 10	36	40 07157 50416 6

039
E6,3



		Артикул		EAN - код
Набор бит с 6-ти гранной торцевой головкой 6 / 7 / 8 / 10 / 12 / 13 mm	1	039 961 06	550	40 07157 63841

Специальные биты для прямой посадки

A5,5
AEG
BOSC
HOLZ-HER
KRESS
METABO

G7
BAIER
FEIN

C8
BOSCH
FEIN
HOLZ-HER
LECUREUX
METABO

M5
B4LLHOFF/
UNIQUIC
HOLZ-HER
WEBER

10/32" NA
USM
DUOFAST
DVSG

011 A 5,5



PZ				Артикул		ЕАН - код
2	50 mm	A 5,5	5,5 mm 10	011 025 10	10	40 07157 30021 8
3	50 mm	A 5,5	5,5 mm 10	011 035 10	12	40 07157 30023 2

012 A 5,5



PH				Артикул		ЕАН - код
2	50 mm	A 5,5	5,5 mm 10	012 025 10	10	40 07157 30027 0
3	50 mm	A 5,5	5,5 mm 10	012 035 10	13	40 07157 30029 4

014 A 5,5



mm				Артикул		ЕАН - код
2,5	50 mm	A 5,5	5,5 mm 10	014 255 10	7	40 07157 30031 7
3,0	50 mm	A 5,5	5,5 mm 10	014 305 10	8	40 07157 30033 1
4,0	50 mm	A 5,5	5,5 mm 10	014 405 10	9	40 07157 30035 5
5,0	50 mm	A 5,5	5,5 mm 10	014 505 10	11	40 07157 30037 9
6,0	50 mm	A 5,5	5,5 mm 10	014 605 10	12	40 07157 30039 3

felo ваш специалист с большим опытом в изготовлении продукции под нужды потребителей и решений самого высокого качества.



061 6,3 mm



PZ				Артикул		EAN - код
1/2	60 mm	1/4"	10	061 126 10	13	40 07157 30429 2
2/2	60 mm	1/4"	10	061 226 10	13	40 07157 50522 4
2/3	60 mm	1/4"	10	061 236 10	14	40 07157 30431 5

062 6,3 mm



PH				Артикул		EAN - код
1/2	60 mm	1/4"	10	062 126 10	12	40 07157 30433 9
2/2	60 mm	1/4"	10	062 226 10	13	40 07157 50524 8
2/3	60 mm	1/4"	10	062 236 10	13	40 07157 30435 3

063 6,3 mm



PH				Артикул		EAN - код
5,5 PH2	60 mm	1/4"	10	063 255 10	12	40 07157 32556 3

070 C 8



				Артикул		EAN - код
5,5 x 0,8	32 mm	C 8	5/16"	070 514 10	8	40 07157 30988 4
5,5 x 1,0	32 mm	C 8	5/16"	070 524 10	8	40 07157 30989 1
6,0 x 1,0	32 mm	C 8	5/16"	070 604 10	9	40 07157 30990 7
6,5 x 1,2	32 mm	C 8	5/16"	070 614 10	9	40 07157 30991 4
8,0 x 1,2	32 mm	C 8	5/16"	070 804 10	11	40 07157 30992 1
8,0 x 1,6	32 mm	C 8	5/16"	070 814 10	11	40 07157 30993 8
10,0 x 1,6	38 mm	C 8	5/16"	070 104 10	17	40 07157 30986 0
12,0 x 2,0	38 mm	C 8	5/16"	070 204 10	21	40 07157 30987 7

071 C 8



PZ				Артикул		EAN - код
1	32 mm	C 8	5/16"	071 010 10	9	40 07157 30994 5
2	32 mm	C 8	5/16"	071 020 10	10	40 07157 30995 2
3	32 mm	C 8	5/16"	071 030 10	11	40 07157 30996 9
4	38 mm	C 8	5/16"	071 042 10	17	40 07157 30997 6

072 C 8



PH				Артикул		ЕАН - код
1	32 mm	C 8	5/16"	10	072 010 10	9 40 07157 30998 3
2	32 mm	C 8	5/16"	10	072 020 10	10 40 07157 30999 0
3	32 mm	C 8	5/16"	10	072 030 10	10 40 07157 31000 2
4	38 mm	C 8	5/16"	10	072 042 10	16 40 07157 31001 9

074 C 8



mm				Артикул		ЕАН - код
3	32 mm	C 8	5/16"	10	074 300 10	10 40 07157 31003 3
4	32 mm	C 8	5/16"	10	074 400 10	10 40 07157 31004 0
5	32 mm	C 8	5/16"	10	074 500 10	11 40 07157 31005 7
6	32 mm	C 8	5/16"	10	074 600 10	12 40 07157 31006 4
8	32 mm	C 8	5/16"	10	074 800 10	13 40 07157 31007 1
10	32 mm	C 8	5/16"	10	074 100 10	20 40 07157 31002 6

076 C 8



Torx®				Артикул		ЕАН - код
25	32 mm	C 8	5/16"	10	076 253 10	10 40 07157 31008 8
27	32 mm	C 8	5/16"	10	076 273 10	10 40 07157 31009 5
30	32 mm	C 8	5/16"	10	076 303 10	11 40 07157 31010 1
40	32 mm	C 8	5/16"	10	076 403 10	11 40 07157 31011 8
45	32 mm	C 8	5/16"	10	076 453 10	12 40 07157 31012 5
50	32 mm	C 8	5/16"	10	076 503 10	13 40 07157 31013 2
55	32 mm	C 8	5/16"	10	076 553 10	18 40 07157 31014 9

078 C 8



XZN				Артикул		ЕАН - код
M 5	35 mm	C 8	5/16"	10	078 050 10	11 40 07157 50384 8
M 6	35 mm	C 8	5/16"	10	078 060 10	12 40 07157 50386 2
M 8	35 mm	C 8	5/16"	10	078 080 10	13 40 07157 50388 6
M10	35 mm	C 8	5/16"	10	078 100 10	17 40 07157 50390 9
M12	35 mm	C 8	5/16"	10	078 120 10	22 40 07157 50392 3

078 C 8



XZN				Артикул		ЕАН - код
M 5	120 mm	C 8	5/16"	10	078 005 10	27 40 07157 50394 7
M 6	120 mm	C 8	5/16"	10	078 006 10	48 40 07157 50396 1
M 8	120 mm	C 8	5/16"	10	078 008 10	45 40 07157 50398 5
M 10	120 mm	C 8	5/16"	10	078 010 10	71 40 07157 50400 5
M 12	120 mm	C 8	5/16"	10	078 012 10	95 40 07157 50402 9

081

Резьба



PZ				Артикул		EAN - код
2	44,5 mm	M 5	6 mm 10	081 020 10	9	40 07157 31354 6
2	44,5 mm	10/32" NFA	6 mm 10	081 025 10	8	40 07157 31355 3

082

Резьба



PH				Артикул		EAN - код
2	33 mm	M 5	6 mm 10	082 020 20	6	40 07157 53645 7
2	44,5 mm	M 5	6 mm 10	082 020 10	8	40 07157 31356 0
2	44,5 mm	M 6	8 mm 10	082 225 10	8	40 07157 62407 9
2	44,5 mm	10/32" NFA	6 mm 10	082 025 10	8	40 07157 31357 7

086

Резьба



Torx *				Артикул		EAN - код
20	44,5 mm	M 5	6 mm 10	086 200 10	9	40 07157 31358 4
20	44,5 mm	M 5	6 mm 10	086 250 10	10	40 07157 31359 1
20	44,5 mm	M 6	8 mm 10	086 020 10	9	40 07157 63843 4
20	44,5 mm	M 6	8 mm 10	086 025 10	10	40 07157 63845 8



038

Резьба



			Артикул		EAN - код
185 mm	M 6	8,5 mm 1	038 200 10	88	40 07157 63847 2





038

Резьба







			Артикул		EAN - код
200 mm	M 6	8,5 mm 1	038 200 20	81	40 07157 63849 6



						Артикул		EAN - код
	2 x	IMPACT PZ 1	25 mm	C 6,3	10	021 012 41	13	40 07157 63001 8
	2 x	IMPACT PZ 2	25 mm	C 6,3	10	021 022 41	13	40 07157 63003 2
	2 x	IMPACT PZ 3	25 mm	C 6,3	10	021 032 41	15	40 07157 63005 6
	1 x	IMPACT PZ 1	50 mm	E 6,3	10	031 015 41	18	40 07157 63025 4
	1 x	IMPACT PZ 2	50 mm	E 6,3	10	031 025 41	18	40 07157 63027 8
	1 x	IMPACT PZ 3	50 mm	E 6,3	10	031 035 41	19	40 07157 63029 2
	2 x	IMPACT PH 1	25 mm	C 6,3	10	022 012 41	13	40 07157 62995 1
	2 x	IMPACT PH 2	25 mm	C 6,3	10	022 022 41	13	40 07157 62997 5
	2 x	IMPACT PH 3	25 mm	C 6,3	10	022 032 41	15	40 07157 62999 9
	1 x	IMPACT PH 1	50 mm	E 6,3	10	032 015 41	18	40 07157 63019 3
	1 x	IMPACT PH 2	50 mm	E 6,3	10	032 025 41	18	40 07157 63021 6
	1 x	IMPACT PH 3	50 mm	E 6,3	10	032 035 41	19	40 07157 63023 0
	2 x	IMPACT Torx *10	25 mm	C 6,3	10	026 102 41	13	40 07157 63007 0
	2 x	IMPACT Torx *15	25 mm	C 6,3	10	026 152 41	13	40 07157 63009 4
	2 x	IMPACT Torx *20	25 mm	C 6,3	10	026 202 41	13	40 07157 63011 7
	2 x	IMPACT Torx *25	25 mm	C 6,3	10	026 252 41	13	40 07157 63013 1
	2 x	IMPACT Torx *30	25 mm	C 6,3	10	026 302 41	15	40 07157 63015 5
	2 x	IMPACT Torx *40	25 mm	C 6,3	10	026 402 41	15	40 07157 63017 9
	1 x	IMPACT Torx *10	50 mm	E 6,3	10	036 105 41	18	40 07157 63031 5
	1 x	IMPACT Torx *15	50 mm	E 6,3	10	036 155 41	18	40 07157 63033 9
	1 x	IMPACT Torx *20	50 mm	E 6,3	10	036 205 41	18	40 07157 63035 3
	1 x	IMPACT Torx *25	50 mm	E 6,3	10	036 255 41	18	40 07157 63037 7
	1 x	IMPACT Torx *30	50 mm	E 6,3	10	036 305 41	19	40 07157 63039 1
	1 x	IMPACT Torx *40	50 mm	E 6,3	10	036 405 41	19	40 07157 63041 4



					Артикул		EAN - код
	2 x	3,5 x 0,6	25 mm C 6,3	10	020 310 36	13	40 07157 10263 8
	2 x	4,0 x 0,8	25 mm C 6,3	10	020 410 36	15	40 07157 10264 5
	2 x	5,5 x 1,0	25 mm C 6,3	10	020 520 36	15	40 07157 10265 2
	2 x	6,5 x 1,2	25 mm C 6,3	10	020 610 36	17	40 07157 10266 9
	2 x	8,0 x 1,2	25 mm C 6,3	10	020 800 36	19	40 07157 10267 6
	2 x	PZ 1	25 mm C 6,3	10	021 010 36	15	40 07157 10275 1
	2 x	PZ 2	25 mm C 6,3	10	021 020 36	15	40 07157 10276 8
	2 x	PZ 3	25 mm C 6,3	10	021 030 36	17	40 07157 10277 5
	3 x 1	PZ 1 / PZ 2 / PZ 3	25 mm C 6,3	10	021 932 16	21	40 07157 10281 2
	1 x	PZ 4	32 mm C 6,3	10	021 042 36	18	40 07157 51799 9
	2 x	PZ 1	50 mm E 6,3	10	031 015 36	28	40 07157 51637 4
	2 x	PZ 2	50 mm E 6,3	10	031 025 36	32	40 07157 10287 4
	3 x 1	PZ 1 / PZ 2 / PZ 3	50 mm E 6,3	10	031 932 16	41	40 07157 31306 5
	2 x	PZ 2	73 mm E 6,3	10	031 027 36	42	40 07157 10292 8
	2 x	PH 1	25 mm C 6,3	10	022 010 36	15	40 07157 10270 6
	2 x	PH 2	25 mm C 6,3	10	022 020 36	15	40 07157 10271 3
	2 x	PH 3	25 mm C 6,3	10	022 030 36	17	40 07157 10272 0
	3 x 1	PH 1 / PH2 / PH 3	25 mm C 6,3	10	022 931 16	21	40 07157 10280 5



					📦	Артикул		📦	EAN - код
2 x	PH 1	50 mm	E 6,3	10	032 015 36	30	40 07157 51639 8		
2 x	PH 1	73 mm	E 6,3	10	032 017 36	34	40 07157 50520 0		
2 x	PH 2	50 mm	E 6,3	10	032 025 36	32	40 07157 10286 7		
2 x	PH 2	73 mm	E 6,3	10	032 027 36	42	40 07157 10304 8		
3 x 1	PH 1 / PH 2 / PH 3	50 mm	E 6,3	10	032 931 16	42	40 07157 31305 8		



2 x	2 mm	25 mm	C 6,3	10	024 200 36	15	40 07157 31880 0
2 x	2,5 mm	25 mm	C 6,3	10	024 250 36	15	40 07157 31882 4
2 x	3 mm	25 mm	C 6,3	10	024 300 36	15	40 07157 31884 8
2 x	4 mm	25 mm	C 6,3	10	024 400 36	15	40 07157 31886 2
2 x	5 mm	25 mm	C 6,3	10	024 500 36	17	40 07157 10291 1
2 x	6 mm	25 mm	C 6,3	10	024 600 36	19	40 07157 10290 4
2 x	8 mm	25 mm	C 6,3	10	024 800 36	23	40 07157 31888 6





2 x	Torx ^R 5	25 mm	C 6,3	10	026 050 36	13	40 07157 52865 0
2 x	Torx ^R 6	25 mm	C 6,3	10	026 060 36	13	40 07157 10303 1
2 x	Torx ^R 7	25 mm	C 6,3	10	026 070 36	13	40 07157 10302 4
2 x	Torx ^R 8	25 mm	C 6,3	10	026 080 36	13	40 07157 10301 7
2 x	Torx ^R 9	25 mm	C 6,3	10	026 090 36	13	40 07157 10300 0
2 x	Torx ^R 10	25 mm	C 6,3	10	026 100 36	15	40 07157 10299 7
2 x	Torx ^R 15	25 mm	C 6,3	10	026 150 36	15	40 07157 10298 0
2 x	Torx ^R 20	25 mm	C 6,3	10	026 200 36	15	40 07157 10297 3
2 x	Torx ^R 25	25 mm	C 6,3	10	026 250 36	15	40 07157 10296 6
2 x	Torx ^R 27	25 mm	C 6,3	10	026 270 36	15	40 07157 10295 9
2 x	Torx ^R 30	25 mm	C 6,3	10	026 300 36	17	40 07157 10294 2
2 x	Torx ^R 40	25 mm	C 6,3	10	026 400 36	17	40 07157 22194 0
3 x 1	Torx ^R 10 / Torx ^R 15 / Torx ^R 20	25 mm	C 6,3	10	026 931 16	20	40 07157 32222 7
3 x 1	Torx ^R 15 / Torx ^R 20 / Torx ^R 25	25 mm	C 6,3	10	026 933 16	20	40 07157 52157 6
2 x	Torx ^R 15	50 mm	E 6,3	10	036 155 36	24	40 07157 51867 5
2 x	Torx ^R 20	50 mm	E 6,3	10	036 205 36	26	40 07157 51869 9
2 x	Torx ^R 25	50 mm	E 6,3	10	036 255 36	26	40 0715 751871 2
2 x	Torx ^R 30	50 mm	E 6,3	10	036 305 36	30	40 0715 751875 0
3 x 1	Torx ^R 10 / Torx ^R 15 / Torx ^R 20	50 mm	E 6,3	10	036 931 16	34	40 07157 52243 6
3 x 1	Torx ^R 20 / Torx ^R 25 / Torx ^R 30	50 mm	E 6,3	10	036 932 16	37	40 07157 52241 2



020



		Артикул		EAN - код
	10	020 801 06	152	40 07157 63427 6
(1 x) 020:		5,5 x 1,0		
(1 x) 021:		PZ 2		
(3 x) 022:		PH 1 / PH 2 / PH 3		
(3 x) 026:		Torx [®] 15 / Torx [®] 20 / Torx [®] 25		
(1 x) 038:		Держатель бит (58 mm)		



020



		Артикул		EAN - код
	10	020 802 46	193	40 07157 63429 0
(1 x) 026:		Torx [®] 10		
(1 x) 026:		Torx [®] 15		
(1 x) 026:		Torx [®] 20		
(2 x) 026:		Torx [®] 25		
(2 x) 026:		Torx [®] 30		
(1 x) 026:		Torx [®] 40		
(1 x) 038:		Держатель бит (58 mm)		
(1 x) 038:		ИМПАСТ Держатель бит		





020



		Артикул		EAN - код
Набор бит 7 шт.	10	020 601 16	72	40 07157 51391 5
(2 x) 026:	5,5 x 1,0 / 6,5 x 1,2			
(2 x) 026:	PZ 1 / PZ 2			
(2 x) 026:	PH 1 / PH 2			
(1 x) 038:	Держатель бит			

020



		Артикул		EAN - код
Набор бит 7 шт.	10	020 603 16	73	40 07157 51395 3
(6 x) 026:	Torx ^R 10 / Torx ^R 15 / Torx ^R 20 / Torx ^R 25 / Torx ^R 30 / Torx ^R 40 /			
(1 x) 038:	Держатель бит			

020





		Артикул		EAN - код
Набор бит 7 шт.	10	020 603 26	72	40 07157 51689 3
(3 x) 021:	PZ 1 / PZ 2 / PZ 3			
(3 x) 022:	PH 1 / PH 2 / PH 3			
(1 x) 038:	Держатель бит			



020



		Артикул		EAN - код
Набор бит 31 шт.	10	020 131 16	286	40 07157 64417 6
(30 x)	Биты С6,3 x 25 mm			
	1x 0,6 x 4,5 / 1x 5,5 x 0,8 / 1x 6,5 x 1,2			
	2x PH 1 / 2x PH 2 / 1x PH 3 / 1x PZ 1 / 2x PZ 2 / 1x PZ 3			
	1x T 10 / 1x T 15 / 5x T 20 / 4x T 25 / 1x T 27 / 1x T 30 / 1x T 40			
	1x 3 mm / 1x 4 mm / 1x 5 mm / 1x 6 mm			
(1 x)	Держатель бит E 6,3 x 58 mm			



020



		Артикул		EAN - код
Набор бит 13 шт.	10	020 910 16	107	40 07157 31405 5
(4 x) 020:	4,0 x 0,8 / 5,5 x 1,0 / 6,5 x 1,2 / 8,0 x 1,2			
(2 x) 021:	PZ 1 / PZ 3			
(2 x) 021:	PZ 2			
(2 x) 022:	PH 1 / PH 3			
(2 x) 022:	PH 2			
(1 x) 038:	Держатель бит 58 mm			

022



		Артикул		EAN - код
Набор бит 13 шт.	10	022 910 16	104	40 07157 31407 9
(2 x) 021:	PZ 1			
(3 x) 021:	PZ 2			
(1 x) 021:	PZ 3			
(2 x) 022:	PH 1			
(3 x) 022:	PH 2			
(1 x) 022:	PH 3			
(1 x) 038:	Держатель бит 58 mm			

026



		Артикул		EAN - код
Набор бит 13 шт.	10	026 910 16	104	40 07157 31409 3
(10 x) 026:	Torx ^R 6 / Torx ^R 7 / Torx ^R 8 / Torx ^R 9 / Torx ^R 10 / Torx ^R 15 / Torx ^R 20 / Torx ^R 27 / Torx ^R 30 / Torx ^R 40 /			
(2 x) 026:	Torx ^R 25			
(1 x) 038:	Держатель бит 58 mm			



030



		Артикул		EAN - код
	10	030 915 16	78	40 07157 31410 9
(6 x) 030:	3,0 x 0,5 / 3,5 x 0,6 / 4,0 x 0,8 5,5 x 1,0 / 6,5 x 1,2 / 8,0 x 1,2			

032



		Артикул		EAN - код
	10	032 915 16	78	40 07157 31412 3
(3 x) 031:	PZ 1 / PZ 2 / PZ 3			
(3 x) 032:	PH 1 / PH 2 / PH 3			

036



		Артикул		EAN - код
	10	036 915 16	75	40 07157 31419 2
(6 x) 036:	Torx [®] 10 / Torx [®] 15 / Torx [®] 20 Torx [®] 25 / Torx [®] 30 / Torx [®] 40			

030



		Артикул		EAN - код
	10	030 925 16	75	40 07157 63075 9
(3 x) 030:	3,0 x 0,5 / 4,0 x 0,8 / 5,5 x 1,0			
(1 x) 031:	PZ 2			
(2 x) 032:	PH 1 / PH 2			

030



		Артикул		EAN - код
	10	030 927 16	100	40 07157 63069 8
(3 x) 030:	3,0 x 0,5 / 4,0 x 0,8 / 5,5 x 1,0			
(1 x) 031:	PZ 2			
(2 x) 032:	PH 1 / PH 2			



031



		Артикул		EAN - код
	10	031 927 16	100	40 07157 63071 1
(3 x) 030:	3,0 x 0,5 / 4,0 x 0,8 / 5,5 x 1,0			
(2 x) 031:	Z(+/-) 1 / Z(+/-) 2			
(1 x) 032:	PH 2			

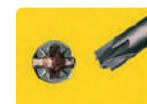

032



		Артикул		EAN - код
	10	032 927 16	100	40 07157 63073 5
(3 x) 030:	3,0 x 0,5 / 4,0 x 0,8 / 5,5 x 1,0			
(2 x) 031:	(+/-) 1 / H(+/-) 2			
(1 x) 032:	PH 2			

030



		Артикул		EAN - код
	10	030 917 16	83	40 07157 31411 6
(5 x) 030:	3,0 x 0,5 / 3,5 x 0,6 / 4,0 x 0,8 5,5 x 1,0 / 6,5 x 1,2			

032



		Артикул		EAN - код
	10	032 917 16	112	40 07157 31385 0
(3 x) 031:	PZ 1 / PZ 2 / PZ 3			
(3 x) 032:	PH 1 / PH 2 / PH 3			

036



		Артикул		EAN - код
	10	036 917 16	100	40 07157 31417 8
(6 x) 036:	Torx [®] * 10 / Torx [®] * 15 / Torx [®] * 20 Torx [®] * 25 / Torx [®] * 30 / Torx [®] * 40			



Плоскогубцы электрика с многофункциональными возможностями для точной и эффективной работы при самых высоких стандартах безопасности.

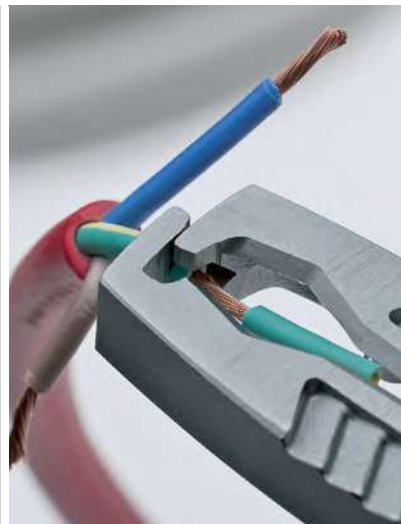

Плоскогубцы **felo**: инновации, изысканный дизайн



Лучшие клещи немецкого производства, которые производятся при самых строгих требованиях к качеству.



Захват и отрезание: только при выполнении тяжелых работ можно оценить качество профессионального инструмента.





Точно зазубренные губки
обеспучивают надёжный захват

Длительная защита от
коррозии за счёт
специальной матовой
хромированной
поверхности

Индукционная закаленная
режущая кромка (60/64 HRC)

Выдающиеся режущие
характеристики и
высочайшая точность

Точное соединение для оптимального рычага

Плоскогубцы

Профессиональное
качество для
интенсивного
ИСПОЛЬЗОВАНИЯ

Форма ручек обеспечивает
безопасность хвата

Выкованные из
специальной стали

Эргономичный
усовершенствованный дизайн
для максимального комфорта

Технология
двухкомпонентной ручки

Красная / желтая модель,
индивидуально протестированная с
напряжением 10000 В,
сертифицированная для
1000 В (VDE IEC 60900)

Проверен на
безопасность GS

Превосходная твердость,
которая превышает
требования DIN ISO на 100 %



EAN- код на каждом
товаре



Соединение SystemClip
для страховочного шнура.

Качество производства и
материалов гарантировано

590



		Артикул		EAN - код
165 mm	6	590 016 40	170	40 07157 63771 0
180 mm	6	590 018 40	240	40 07157 63773 4

590



		Артикул		EAN - код
240 mm	6	590 024 40	380	40 07157 63817 5

НОВИНКА

591



		Артикул		EAN - код
128 mm	6	591 128 40	75	40 07157 64701 6

591



		Артикул		EAN - код
145 mm	6	591 014 40	160	40 07157 63775 8
160 mm	6	591 016 40	200	40 07157 63777 2
180 mm	6	591 018 40	240	40 07157 63779 6



591



		Артикул		EAN - код
180 mm	6	591 118 40	245	40 07157 63781 9



591



		Артикул		EAN - код
180 mm	6	591 318 40	245	40 07157 64283 7
200 mm	6	591 020 40	330	40 07157 63789 5



592



		Артикул		EAN - код
170 mm	6	592 017 40	145	40 07157 64281 3
205 mm	6	592 020 40	190	40 07157 63783 3



592



		Артикул		EAN - код
205 mm	6	592 220 40	195	40 07157 63785 7

580



		Артикул		EAN - код
	5	580 001 00	10	40 07157 63851 9



НОВИНКА

895

		Артикул		EAN - код
180 mm	6	895 018 40	180	40 07157 64695 8
240 mm	6	895 025 40	330	40 07157 63787 1
300 mm	6	895 030 40	490	40 07157 64697 2



895

		Артикул		EAN - код
180 mm	6	895 180 40	190	40 07157 64395 7
250 mm	6	895 250 40	340	40 07157 63815 1
300 mm	6	895 300 40	480	40 07157 63819 9
400 mm	6	895 400 40	1105	40 07157 64397 1

НОВИНКА

897



		Артикул		EAN - код
250 mm	6	897 025 40	350	40 07157 65097 9

894



		Артикул		EAN - код
210 mm	6	894 020 40	365	40 07157 63813 7

894



		Артикул		EAN - код
260 mm	6	894 026 40	355	40 07157 64327 8
300 mm	6	894 030 40	490	40 07157 64329 2

Съемники для установки внешних стопорных колец

Противоскользящие наконечники для точных работ

Съемники для установки внутренних стопорных колец

С прямыми губками или под углом 90°



Съемники



С открывающейся пружиной

Ручки с пластиковым покрытием

Изготовлены из хромованадиевой стали, кованные, закаленные в масле



A 2
Ø 19 - 60 mm



593



		Артикул		EAN - код
10 - 25 mm	6	593 010 40	100	40 07157 64287 5
19 - 60 mm	6	593 019 40	150	40 07157 64297 4
40 - 100 mm	6	593 040 40	255	40 07157 64301 8
85 - 140 mm	6	593 085 40	450	40 07157 64305 6

593



		Артикул		EAN - код
10 - 25 mm	6	593 210 40	100	40 07157 64295 0
19 - 60 mm	6	593 219 40	150	40 07157 64299 8
40 - 100 mm	6	593 240 40	255	40 07157 64303 2
85 - 140 mm	6	593 285 40	450	40 07157 64307 0







594

		Артикул		EAN - код
8 - 13 mm	6	594 008 40	100	40 07157 64309 4
12 - 25 mm	6	594 012 40	100	40 07157 64547 0
19 - 60 mm	6	594 019 40	150	40 07157 64313 1
40 - 100 mm	6	594 040 40	255	40 07157 64317 9
85 - 140 mm	6	594 085 40	450	40 07157 64321 6



594

		Артикул		EAN - код
12 - 25 mm	6	594 212 40	100	40 07157 64311 7
19 - 60 mm	6	594 219 40	150	40 07157 64315 5
40 - 100 mm	6	594 240 40	255	40 07157 64319 3
85 - 140 mm	6	594 285 40	450	40 07157 64323 0

Точно зазубренные губки обеспечивают надёжный захват

Индукционная закаленная режущая кромка (60/64 HRC)

Точное соединение для оптимального рычага



Длительная защита от коррозии из специальной матовой хромированной поверхности

Выдающиеся режущие характеристики и высочайшая точность

Плоскогубцы

Профессиональное качество для интенсивного использования

Форма ручек обеспечивает безопасность хвата

Эргономичный усовершенствованный дизайн для максимального комфорта

Красная / желтая модель, индивидуально протестированная с напряжением 10000 В, сертифицированная для 1000 В (VDE IEC 60900)

Превосходная твердость, которая превышает требования DIN ISO на 100 %



Соединение SystemClip для страховочного шнура.

Выкованные из специальной стали

Технология двухкомпонентной ручки



Проверен на безопасность GS



EAN- код на каждом товаре

Качество производства и материалов гарантировано

Плоскогубцы VDE



Диэлектрический инструмент
произведенный в Германии

   **AC 1000 V**
IEC 60900:2018

580



  **1000 V**
IEC 60900:2018



		Артикул		EAN - код
165 mm	6	580 016 40	180	40 07157 63791 8
180 mm	6	580 018 40	250	40 07157 63793 2
205 mm	6	580 205 40	300	40 07157 64401 5

581

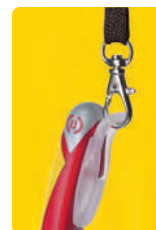

  **1000 V**
IEC 60900:2018





		Артикул		EAN - код
160 mm	6	581 016 40	210	40 07157 63795 6
180 mm	6	581 018 40	240	40 07157 63797 0

582

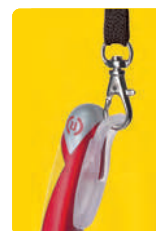

  **1000 V**
IEC 60900:2018



		Артикул		EAN - код
170 mm	6	582 017 40	150	40 07157 63799 4
205 mm	6	582 020 40	200	40 07157 64289 9



582





1000 V
 IEC 60900:2018



		Артикул		ЕАН - код
205 mm	6	582 225 40	200	40 07157 63801 4



583





1000 V
 IEC 60900:2018



		Артикул		ЕАН - код
160 mm	6	583 016 40	180	40 07157 63803 8



584





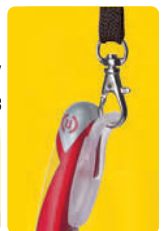



1000 V
 IEC 60900:2018

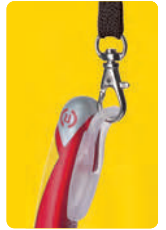

		Артикул		ЕАН - код
160 mm	6	584 016 40	305	40 07157 63805 2
210 mm		584 021 40	315	40 07157 64291 2



581



200 mm		6	581 020 40		305	40 07157 63807 6
--------	---	---	------------	---	-----	------------------

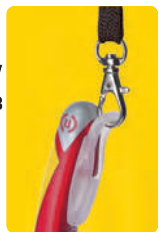

583



190 mm		6	583 019 40		250	40 07157 64399 5
--------	--	---	------------	--	-----	------------------

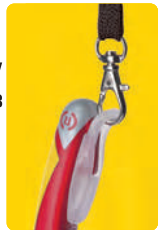

586

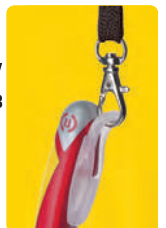

180 mm		6	586 018 40		231	40 07157 63811 3
--------	---	---	------------	---	-----	------------------

580



200 mm		6	580 120 40		295	40 07157 64293 6
--------	---	---	------------	---	-----	------------------

E-Detector

Бесконтактный тестер напряжения сети для шарнирно-губцевого инструмента

Диапазон напряжения 90 - 1000 В

Фонарик для освещения мест измерения

Соответствует стандарту EN 61010-1, категория измерений CAT III/300V



580

	Артикул		EAN - код
6	580 002 00	34	40 03758 81904 3



580

	Артикул		EAN - код
5	580 001 00	10	40 07157 63851 9

Инструмент для снятия изоляции с проводов Превосходное качество для Профессионалов

583



Клещи для снятия изоляции

6

583 999 11

119

40 07157 62681 3

Запасные стержни
хранятся
в рукоятке

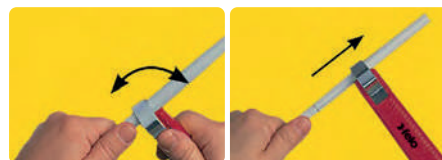

8 ñ 28 mm ÿ
5/16" ñ 1.1/8" ÿ

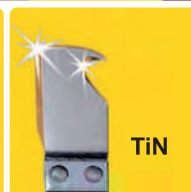
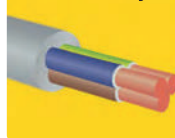

TiN

584



Нож для снятия изоляции

12

584 018 11

96

40 07157 62683 7

592

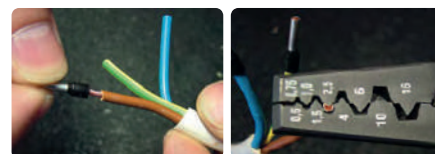

190 mm

6

592 319 40

250

4007157643254

НОВИНКИ

583



		Артикул		EAN - код
220 mm	1	583 220 40	606	40 07157 64811 2
Матрица 1:	0,50 - 6,00 мм ² - Изолированные кабельные наконечники DIN - красный/синий/желтый			
Матрица 2:	0,14 - 10,00 мм ² - Неизолированные кабельные наконечники по DIN			
Матрица 3:	0,10 - 16,00 мм ² - Неизолированные втулочные наконечники			

583



		Артикул		EAN - код
Клещи для снятия изоляции 0,03 - 16 мм ²	1	583 200 40	195	40 07157 64813 6
202 mm				

583



		Артикул		EAN - код
Ручной обжимник 0,08 - 16 мм ²	1	583 190 40	596	40 07157 64815 0
215 mm				

583



		Артикул		EAN - код
Торцевые пресс-клещи для опрессовки НШВИ 0,08 - 16 мм ² поворотные	1	583 230 40	418	40 07157 64839 6
193 mm				

584



		Артикул		EAN - код
Кабелерез секторный	1	584 250 40	602	40 07157 64817 4
260 mm				

Наборы инструментов VDE: идеальное оборудование для Profi



НОВИНКА

413



	Артикул		EAN - код
Набор инструментов Ergonic VDE, E-SMART VDE в кейсе L-Box, 75 шт	413 975 08	6260	40 07157 64961 4
(3 x) 400: 4,0 x 100 / 5,5 x 125 / 6,5 x 150			
(2 x) 401: PZ 1 x 80 / PZ 2 x 100			
(3 x) 408: Torx® 15 x 100 / Torx® 20 x 100 / Torx® 25 x 100			
(1 x) 413: 3,5 x 100			
(1 x) 361: 3,0 x 70			
(1 x) 397: Т-образная отвертка под головки 1/4"			
(1 x) 057: Набор бит с трещоткой Ergonic в кейсе, 36 шт			
(1 x) 063: Набор E-Smart в кейсе, 14 шт			
(1 x) 365: Набор шестигранных ключей с шаровым окончанием, 9 шт			
(1 x) 580: Пассатижи диэлектрические 180 мм			
(1 x) 581: Бокорезы диэлектрические 160 мм			
(1 x) 895: Клещи переставные 250 мм			
(1 x) 580: Бесконтактный тестер сети			
(1 x) C00: Универсальный трещоточный нож L-5			
L-Box			



НОВИНКА

413



VDE GS
1000 V
 IEC 60900:2018

	Артикул		EAN - код
Набор инструментов Ergonic VDE E-slim в кейсе XL-Box, 78 шт	413 878 18	9500	40 07157 64963 8
(7 x) 413:	3,0 x 100 / 3,5 x 0,6 x 100 / 3,5 x 0,8 x 100 / 4,0 x 100 / 4,5 x 125 / 5,5 x 125 / 6,5 x 125		
(2 x) 414:	PH 1 x 80 / PH 2 x 100		
(2 x) 415:	PZ 1 x 80 / PZ 2 x 100		
(2 x) 416:	H 1 x 80 / H 2 x 100		
(3 x) 418:	Torx® 15 x 100 / Torx® 20 x 125 / Torx® 25 x 125		
(1 x) 450:	12,0 x 210		
(1 x) 361:	3,0 x 70		
(1 x) 063:	Ключ универсальный для ящиков		
(1 x) 580:	Бесконтактный тестер сети "E-Detector"		
(1 x) 580:	Пассатижи диэлектрические 180 мм		
(1 x) 581:	Бокорезы диэлектрические 160 мм		
(2 x) 584:	Нож для снятия изоляции		
(2 x) 582:	Длинногубцы диэлектрические с резцом 205 мм / Длинногубцы диэлектрические угловые с резцом 205 мм		
(1 x) 583:	Клещи для снятия изоляции 16 мм		
(1 x) 583:	Торцевые пресс-клещи для опрессовки НШВИ поворотные		
(1 x) 057:	Набор бит с трещоткой Ergonic в кейсе, 36 шт		
(1 x) 365:	Набор шестигранных ключей с шаровым окончанием, 9 шт		
(1 x) 895:	Клещи переставные 250 мм		
(1 x) C00:	Универсальный трещоточный нож L-5		
(2 x) 000:	Уровень электрика / Метр складной деревянный XL-Box		



413



	Артикул		EAN - код
Набор диэлектрических инструментов Ergonic VDE, 11 шт в сумке	413 911 04	1580	40 07157 63855 7
(3 x) 413: 3,5 x 100 / 4,0 x 100 / 5,5 x 125			
(3 x) 414: PH 0 x 60 / PH 1 x 80 / PH 2 x 100			
(1 x) 580: Плоскогубцы VDE 180 mm			
(1 x) 582: Бокорезы VDE 160 mm			
(1 x) 582: Длинногубцы VDE 170 mm			
(1 x) 584: Стриппер			
(1 x) 361: VDE Отвертка- тестер напряжения сети 3,0 mm x 70 mm			
(1 x) Сумка 330x270x55 мм			



413



	Артикул		EAN - код
Набор диэлектрических инструментов Ergonic Slim VDE, 11 шт в сумке	413 811 04	1615	40 07157 63857 1
(3 x) 413: 3,5 x 100 / 4,0 x 100 / 5,5 x 125			
(3 x) 414: PH 1 x 80 / PH 2 x 100			
(3 x) 415: PZ 2 x 100			
(1 x) 580: Плоскогубцы VDE 180 mm			
(1 x) 582: Бокорезы VDE 160 mm			
(1 x) 582: Длинногубцы VDE 170 mm			
(1 x) 584: Стриппер			
(1 x) 361: VDE Отвертка- тестер напряжения сети 3,0 mm x 70 mm			
(1 x) Сумка 330x270x55 мм			



DVE GS
1000 V
 IEC 60900:2013

413



	Артикул		EAN - код
Набор диэлектрических инструментов Ergonic VDE, 9 шт в поясной сумке	413 995 04	1040	40 07157 63859 5
(3 x) 413:	3,5 x 100 / 4,0 x 100 / 5,5 x 125		
(2 x) 414:	PH 1 x 80 / PH 2 x 100		
(3 x) 415:	PZ 2 x 100		
(1 x) 580:	Плоскогубцы VDE 180 mm		
(1 x) 582:	Бокорезы VDE 160 mm		
(1 x) 361:	VDE Отвертка- тестер напряжения сети 3,0 mm x 70 mm		
(1 x)	Стриппер		
Сумка 290x250x20 мм			



DVE GS
1000 V
 IEC 60900:2013

413



	Артикул		EAN - код
Набор диэлектрических инструментов Ergonic VDE, 8 шт	413 985 17	1070	40 07157 63853 3
(3 x) 413:	3,5 x 100 / 4,0 x 100 / 5,5 x 125		
(2 x) 414:	PH 0 x 60 / PH 1 x 80 / PH 2 x 100		
(1 x) 580:	Плоскогубцы VDE 180 mm		
(1 x) 581:	Бокорезы VDE 160 mm		

Торговое оборудование Дисплей

Наши выставочные стенды могут быть размещены в любом месте в торговой точке и полезны для рекламных акций в точках продаж.



Интеллектуальные концепции продаж для специализированной торговли и идеальной демонстрации продукции. Мы дадим вам профессиональный совет и разработаем концепцию, соответствующую вашим потребностям.



Индекс артикула

Art.-Nr. Item No	Seite Page
01102510	112
01103510	112
01202510	112
01203510	112
01425510	112
01430510	112
01440510	112
01450510	112
01460510	112
01810290	96
02013116	120
02030010	101
02031010	101
02031036	117
02041010	101
02041036	117
02052010	101
02052036	117
02060116	120
02060316	120
02060326	120
02061010	101
02061036	117
02071906	72
02071946	72
02073006	69
02073016	69
02073516	71
02073526	71
02073806	70
02080010	101
02080036	117
02080106	119
02080246	119
02082136	70
02090610	103
02090810	103
02091010	103
02091016	121
02093100	120
02100010	101
02101010	101
02101017	101
02101036	117
02101040	107
02101070	109
02101077	109
02101080	108
02101241	116
02102010	101
02102017	101

Art.-Nr. Item No	Seite Page
02102036	117
02102040	107
02102070	109
02102076	109
02102080	108
02102241	116
02103010	101
02103017	101
02103036	117
02103040	107
02103070	109
02103077	109
02103080	108
02103241	116
02104210	101
02104236	117
02193216	117
02200010	101
02200210	101
02200270	109
02201010	101
02201017	101
02201036	117
02201040	107
02201070	109
02201077	109
02201080	108
02201241	116
02202010	101
02202017	101
02202036	117
02202040	107
02202070	109
02202077	109
02202080	108
02202241	116
02203010	101
02203017	101
02203036	117
02203040	107
02203070	109
02203077	109
02203080	108
02203241	116
02204210	101
02291016	121
02293116	117
02306010	102
02307010	102
02308010	102
02309010	102

Art.-Nr. Item No	Seite Page
02310010	102
02315010	102
02320010	102
02325010	102
02327010	102
02330010	102
02340010	102
02420010	101
02420036	118
02423810	101
02425010	101
02425036	118
02430010	101
02430036	118
02430040	107
02440010	101
02440036	118
02440040	107
02447620	101
02450010	101
02450036	118
02450040	107
02455010	101
02460010	101
02460036	118
02460040	107
02463520	101
02480010	101
02480036	118
02500010	102
02510010	102
02510040	107
02520010	102
02520040	107
02530010	102
02530040	107
02605010	102
02605036	118
02606010	102
02606036	118
02607010	102
02607036	118
02608010	102
02608036	118
02609010	102
02609036	118
02610010	102
02610017	102
02610036	118
02610040	107
02610070	109

Art.-Nr. Item No	Seite Page
02610241	116
02615010	102
02615017	102
02615036	118
02615040	107
02615070	109
02615077	109
02615241	116
02620010	102
02620017	102
02620036	118
02620040	107
02620070	109
02620077	109
02620241	116
02625010	102
02625017	102
02625036	118
02625040	107
02625070	109
02625077	109
02625241	116
02627010	102
02627036	118
02627040	107
02627070	109
02630010	102
02630017	102
02630036	118
02630040	107
02630070	109
02630241	116
02640010	102
02640017	102
02640036	118
02640040	107
02640070	109
02640241	116
02645010	102
02645070	109
02650010	102
02650110	102
02691016	121
02693116	118
02693316	118
02707010	102
02708010	102
02709010	102
02710010	102
02715010	102
02720010	102
02725010	102
02727010	102
02730010	102
02740010	102
02804010	103
02805010	103
02806010	103
02808010	103

Art.-Nr. Item No	Seite Page
02810010	103
02893010	103
02894010	103
02900010	103
02901010	103
02902010	103
02903010	103
02904010	103
02905010	103
02906010	103
02908010	103
02910010	103
02930010	110
02940010	110
02950010	110
02951010	103
02952010	103
02953010	103
02954010	103
02955010	103
02960010	110
03010510	103
03030510	103
03030710	105
03031510	103
03031710	105
03041510	103
03041710	105
03041810	106
03052510	103
03052710	105
03052810	106
03061510	103
03061710	105
03061810	106
03081510	103
03081810	106
03091516	121
03091716	122
03092516	122
03092716	122
03101510	103
03101536	117
03101540	107
03101541	116
03101570	109
03101710	105
03101810	106
03101910	106
03102510	103
03102536	117
03102540	107
03102541	116
03102570	109
03102710	105
03102736	117
03102810	106
03102910	106
03103510	103

Art.-Nr. Item No	Seite Page
03103540	107
03103541	116
03103570	109
03103710	105
03103810	106
03103910	106
03110110	105
03120210	105
03192716	122
03193216	117
03200510	104
03201510	104
03201536	118
03201540	107
03201541	116
03201570	109
03201710	105
03201736	118
03201810	106
03201910	106
03202510	104
03202517	104
03202536	118
03202540	107
03202541	116
03202570	109
03202710	105
03202736	118
03202810	106
03202910	106
03203510	104
03203540	107
03203541	116
03203570	109
03203710	105
03210110	105
03220210	105
03291516	121
03291716	122
03292716	122
03293116	118
03310510	104
03315510	104
03320510	104
03325510	104
03330510	104
03425510	104
03430510	104
03430540	108
03440510	104
03440540	108
03450510	104
03450540	108
03460510	104
03460540	108
03480510	104
03500710	105
03501710	105
03502710	105

Art.-Nr. Item No	Seite Page
03503710	105
03510510	104
03510540	108
03520510	104
03520540	108
03530510	104
03530540	108
03605510	104
03606510	104
03607510	104
03608510	104
03609510	104
03610010	106
03610510	104
03610540	108
03610541	116
03610710	105
03610910	106
03615010	106
03615510	104
03615536	118
03615540	108
03615541	116
03615710	105
03615910	106
03620010	106
03620510	104
03620536	118
03620540	108
03620541	116
03620710	105
03620910	106
03625010	106
03625510	104
03625536	118
03625540	108
03625541	116
03625710	105
03625910	106
03627510	104
03627540	108
03627710	105
03630010	106
03630510	104
03630536	118
03630540	108
03630541	116
03630710	105
03630910	106
03640510	104
03640540	108
03640541	116
03640710	105
03640910	106
03691516	122
03691716	122
03693116	118
03693216	118
03710390	96

Art.-Nr. Item No	Seite Page
03810290	96
03810390	96
03810396	96
03810590	96
03810790	96
03810890	96
03810990	96
03816590	100
03816594	100
03816990	100
03817090	100
03820010	115
03820020	115
03829590	99
03829594	99
03903810	111
03905010	111
03906010	111
03907010	111
03908010	111
03909010	111
03910010	111
03911010	111
03912010	111
03913010	111
03951610	111
03996106	111
04810280	97
05681318	75
05763501	73
05771806	67
05771856	68
05771866	25
05772306	67
05773306	68
05781006	63
05781906	62
05781956	65
05782706	64
05783606	64
05783616	62
05783656	65
05798106	75
05810290	97
05910390	96
06071604	49
06072006	49
06072206	50
06080904	53
06081306	53
06081506	54
06082006	55
06092006	56
06092036	57
06110504	59
06112610	113
06120604	59
06122610	113
06123610	113

Art.-Nr. Item No	Seite Page
06130704	59
06202304	59
06210404	59
06210704	59
06212610	113
06220604	59
06222610	113
06223610	113
06300004	42
06300094	46
06302504	42
06302594	46
06303004	42
06303094	46
06303504	42
06303594	46
06304004	42
06304094	46
06305504	42
06305594	46
06306504	42
06306594	46
06308304	42
06310004	42
06310094	46
06310204	42
06310214	42
06310294	46
06310295	46
06310304	42
06310394	46
06310500	42
06311204	42
06311214	42
06311294	46
06311295	46
06315304	42
06315394	46
06320004	42
06320094	46
06320304	42
06320314	42
06320324	42
06320394	46
06320395	46
06320396	46
06320500	46
06322304	42
06322314	42
06322394	46
06322395	46
06325510	113
06330004	42
06330094	46
06381204	45
06381206	45
06391306	40
06391316	41
06391904	41

Art.-Nr. Item No	Seite Page
06399901	42
06403404	59
06405604	59
06500104	59
06502304	59
06606704	59
06608904	59
06611504	59
06622504	59
06634004	59
06711504	59
06722504	59
06734004	59
06805504	56
06805524	55
06806004	56
06806024	55
06807004	56
06807024	55
06808004	56
06808024	55
06810004	56
06810024	55
06811004	56
06811104	57
06812704	57
06813004	56
06813024	56
06814204	57
06817004	56
06817024	55
06855504	57
06863504	57
06863514	59
06871404	57
06879304	57
06895204	57
06910500	58
06920500	58
07010410	113
07020410	113
07051410	113
07052410	113
07060410	113
07061410	113
07080410	113
07081410	113
07101010	113
07102010	113
07103010	113
07104210	113
07201010	114
07202010	114
07203010	114
07204210	114
07410010	114
07430010	114
07440010	114
07450010	114

Art.-Nr. Item No	Seite Page
07460010	114
07480010	114
07625310	114
07627310	114
07630310	114
07640310	114
07645310	114
07650310	114
07655310	114
07800510	114
07800610	114
07800810	114
07801010	114
07801210	114
07805010	114
07806010	114
07808010	114
07810010	114
07812010	114
07908010	110
07910010	110
08102010	115
08102510	115
08202010	115
08202020	115
08202510	115
08222510	115
08602010	115
08602510	115
08620010	115
08625010	115
09604010	74
09604510	74
09605010	74
09605510	74
09605520	63
09606010	74
09606020	63
09607010	74
09607020	63
09608010	74
09608020	63
09609010	74
09610010	74
09610020	63
09611010	74
09612010	74
09613010	74
09613020	63
09614010	74
09620010	74
09621010	74
09622010	74
09623010	74
09624010	74
09625010	74
09626010	74
09627010	74
09628010	74

Art.-Nr. Item No	Seite Page
09629010	74
09630010	74
09631010	74
09632010	74
09700010	74
09701110	97
09701310	97
09701810	73
09701910	73
09702010	97
09705010	73
09707010	73
09710010	73
09715014	59
09771310	76
09771410	76
09792010	76
09913010	76
09914010	76
09915010	76
09916010	76
09917010	76
09918010	76
09919010	76
09921010	76
09922010	76
10000106	79
10000206	79
10000306	79
10000600	79
10003204	80
10004304	80
10004394	81
10006000	79
10035304	80
10035394	81
10055404	80
10055494	81
10099116	78
10099216	78
10099316	78
10100104	80
10110204	80
10110294	81
10120304	80
10120394	81
10200104	80
10210204	80
10210294	81
10220304	80
10220394	81
10401504	80
10402004	80
10402504	80
10403004	80
10404004	80
10610204	80
10620304	80
10620394	81



Art.-Nr. Item No	Seite Page
10710204	80
10710294	81
10720304	80
10720394	81
10806104	80
10807104	80
10808304	80
10809304	80
10810304	80
10810394	81
10815304	80
10815394	81
10820304	80
10820394	81
10825304	80
10825394	81
10906104	80
10907104	80
10908304	80
10909304	80
10910304	80
10915304	80
10920304	80
10925304	80
11812504	80
24003360	83
24003560	83
24003760	83
24004360	83
24004560	83
24004760	83
24015160	83
24020160	83
24025260	83
24025560	83
24025760	83
24033360	83
24035360	83
24035560	83
24035860	83
24096166	84
24100160	83
24110260	83
24200060	83
24200160	83
24200960	83
24210260	83
24210560	83
24302160	83
24305160	83
24306160	83
24396166	84
24510260	83
24615160	84
24620160	84
24625260	84
24630260	84
24805160	84
24806160	84

Art.-Nr. Item No	Seite Page
24807160	84
24808160	84
24809160	84
24810360	84
24810860	84
24815360	84
24815860	84
24820860	84
24896166	84
24930060	84
24935060	84
24940060	84
24945060	84
24950060	84
24955060	84
24996166	85
25003360	85
25003560	85
25015160	85
25020160	85
25025260	85
25096166	85
25110260	85
25200160	85
25200960	85
25210260	85
25615160	85
25620160	85
25625260	85
25630260	85
25805160	85
25806260	85
25807160	85
25808160	85
25809160	85
25810360	85
25815360	85
25820360	85
30303560	89
30304560	89
30305560	89
30306560	89
30308760	89
30310760	89
30320360	89
30325360	89
30397160	91
30406460	89
30406860	89
30407860	89
30408460	89
30408860	89
30408960	89
30409860	89
30410460	89
30410860	89
30410960	89
30411860	89
30412860	89

Art.-Nr. Item No	Seite Page
30413460	89
30413860	89
30413960	89
30417860	89
30455860	89
30810360	89
30815360	89
30820460	89
30825760	89
30827760	89
30830760	89
30840760	89
30845560	89
33503590	24
33504590	24
33505590	24
33506590	24
33508090	24
33510090	24
33512090	24
33595198	24
33595298	24
33597198	24
33610290	24
33620390	24
33630590	24
33710290	24
33720390	24
33730590	24
33812560	90
34004000	90
34005500	90
34008000	90
34112000	90
34134000	90
34212000	90
34234000	90
34326000	90
34500711	93
34500721	95
34501510	93
34502010	93
34502510	93
34503010	93
34503510	93
34504010	93
34504510	93
34505010	93
34506010	93
34507010	93
34508010	93
34509010	93
34510010	93
34511010	93
34512010	93
34513010	93
34514010	93
34517010	93
34519010	93

Art.-Nr. Item No	Seite Page
34522010	93
34524010	93
34527010	93
34600911	94
34601510	93
34602010	93
34602510	93
34603010	93
34604010	93
34605010	93
34606010	93
34608010	93
34610010	93
34800610	94
34800710	94
34800810	94
34800910	94
34801010	94
34801510	94
34802010	94
34802510	94
34802710	94
34803010	94
34804010	94
34804510	94
34805010	94
34808011	94
34810550	92
34810650	92
34810750	92
34810850	92
34810950	92
34811050	92
34811550	92
34812050	92
34888811	94
34890750	92
34910550	92
34910650	92
34910750	92
34910850	92
34910950	92
34911050	92
34911550	92
34912050	92
34990750	92
36130000	38
36130001	38
36135000	38
36135001	38
36140000	38
36140001	38
36500911	95
36501510	95
36502010	95
36502510	95
36503010	95
36504010	95
36505010	95

Art.-Nr. Item No	Seite Page
36506010	95
36508010	95
36510010	95
37310805	87
37320805	87
37400405	87
37420405	87
37513011	95
37604105	87
37604405	87
38990000	58
39109100	-
39712760	90
39763560	90
39795260	90
40002210	11
40003210	11
40004310	11
40004710	11
40004910	11
40005510	11
40006310	11
40006510	11
40006710	11
40008610	11
40008810	11
40010636	16
40010710	11
40020636	16
40035310	11
40055410	11
40055510	11
40055710	11
40055910	11
40061010	11
40065310	11
40065510	11
40065710	11
40091013	16
40091043	16
40091743	15
40092400	-
40093114	17
40093118	17
40095118	17
40095318	17
40096118	17
40097118	17
40100110	11
40110210	11
40120310	11
40120910	11
40130510	11
40200110	11
40210210	11
40210710	11
40220310	11
40220510	11
40220710	11

Art.-Nr. Item No	Seite Page
40220910	11
40221010	11
40230510	11
40400040	12
40410040	12
40420040	12
40430040	12
40493148	17
40710340	12
40715340	12
40720340	12
40725340	12
40727340	12
40730340	12
40740440	12
40796148	18
40805140	12
40806140	12
40807140	12
40808340	12
40809340	12
40810340	12
40815340	12
40820340	12
40825340	12
40827340	12
40830340	12
40840440	12
40845440	12
40893148	18
40896148	18
40896248	18
40906140	12
40907140	12
40908340	12
40909340	12
40910340	12
40915340	12
40920340	12
40925340	12
40927340	12
40930340	12
40940440	12
41140540	11
41240540	11
41302590	31
41303090	31
41303590	31
41303890	31
41304090	31
41304590	31
41305590	31
41306590	31
41308090	31
41380736	37
41381104	140
41385198	37
41385398	37
41387818	139



Art.-Nr. Item No	Seite Page
41391093	32
41391104	140
41393090	36
41393194	32
41393590	36
41393890	36
41394090	36
41394590	36
41395590	36
41396198	32
41396398	32
41396590	36
41397508	138
41398517	141
41399504	141
41400190	31
41410290	31
41419290	36
41420390	31
41429390	36
41430490	31
41491093	32
41510290	31
41519290	36
41520390	31
41529390	36
41530490	31
41610290	31
41619290	36
41620390	31
41629390	36
41710290	31
41719290	36
41720390	31
41729390	36
41784198	36
41792191	32
41810390	31
41810990	36
41815390	31
41815990	36
41820390	31
41820990	36
41825390	31
41825990	36
41830390	31
41884198	37
41905530	33
41906030	33
41907030	33
41908030	33
41910030	33
41910090	31
41910636	33
41913030	33
41919090	36
41920090	31
41929090	36
42004510	10

Art.-Nr. Item No	Seite Page
42005510	10
42210510	14
42220510	14
42720240	13
42725340	13
42730340	13
42740340	13
42750340	13
42760440	13
42780540	13
42804040	13
42805040	13
42805530	13
42805540	13
42806030	13
42806040	13
42807030	13
42807040	13
42808030	13
42808040	13
42809040	13
42810030	13
42810040	13
42810636	18
42811040	13
42812040	13
42813030	13
42813040	13
42814040	13
42905040	13
42906040	13
42907040	13
42908040	13
42910040	13
42963540	15
42973540	15
43810040	15
43812540	14
43812640	14
43812740	14
43812890	14
43899940	50
45004540	21
45005540	21
45007040	21
45008040	21
45009040	21
45010040	21
45012040	21
45095148	21
45095248	21
45095348	22
45110240	21
45120340	21
45130540	21
45210240	21
45220340	21
45230540	21
46003510	27

Art.-Nr. Item No	Seite Page
46005510	27
46006510	27
46101010	27
46102010	27
46201010	27
46202010	27
46815010	27
46820010	27
46825010	27
46902540	27
46902640	27
46926010	27
49004110	26
49306310	26
49400330	26
49412530	26
49431030	26
49711040	15
49720000	15
49763541	73
49783540	76
49806310	26
50003230	22
50003730	22
50004330	22
50004730	22
50035330	22
50035830	22
50110230	22
50120330	22
50120730	22
50210230	22
50210730	22
50220330	22
50220730	22
50810330	22
50815330	22
50820330	22
50825330	22
58000100	126
58000100	135
58000200	135
58001640	132
58001840	132
58012040	134
58020540	132
58101640	132
58101840	132
58102040	134
58201740	132
58202040	132
58222540	133
58301640	133
58301940	134
58319040	137
58320040	137
58322040	137
58323040	137
58399911	136

Art.-Nr. Item No	Seite Page
58401640	133
58401811	136
58402140	133
58425040	137
58601840	134
59001640	125
59001840	125
59002440	125
59101440	125
59101640	125
59101840	125
59102040	126
59111840	125
59112840	125
59131840	126
59201740	126
59202040	126
59222040	126
59231940	136
59301040	129
59301940	129
59304040	129
59308540	129
59321040	129
59321940	129
59324040	129
59328540	129
59400840	130
59401240	130
59401940	130
59404040	130
59408540	130
59421240	130
59421940	130
59424040	130
59428540	130
89402040	127
89402640	127
89403040	127
89501840	127
89502540	127
89503040	127
89518040	127
89525040	127
89530040	127
89540040	127
89702540	127
90002210	7
90003210	7
90004310	7
90008610	7
90035310	7
90055410	7
90065510	7
90095148	8
90095248	8
90095348	8
90100110	7
90110210	7

Art.-Nr. Item No	Seite Page
90120310	7
90130510	7
90200110	7
90210210	7
90220310	7
90230510	7
90410010	8
90420010	8
90806140	7
90807140	7
90808340	7
90809340	7
90810340	7
90815340	7
90820340	7
90825340	7
90827340	7
90830340	7
90895148	8
91302590	29
91303090	29
91303590	29
91304090	29
91305590	29
91306590	29
91396198	29
91396298	29
91400190	29
91410290	29
91420390	29
91430490	29
91500190	29
91510290	29
91520390	29
91530490	29
91910090	29
91920090	29





Felo Werkzeugfabrik GmbH
Emil-Rössler-Straße 59
D - 35279 Neustadt (Hessen)

Tel.: +49 66 92 - 88 0
Fax: +49 66 92 - 88 99
E-Mail: info@felo.com
www.felo.com