

# LANBAO

Hotline  
0086-400-820-8259  
0086-800-820-8259

Add: No.228 jinbi Road, Jinhui Industrial Park,  
Fengxian Area, Shanghai, China 202404  
Tel: 86-21-57486188  
Fax: 86-21-57486199  
E-mail: market@shlanbao.cn  
Website/URL: www.shlanbaosensor.com

Lanbao reserves the right to make changes



# LANBAO

## Product Summary

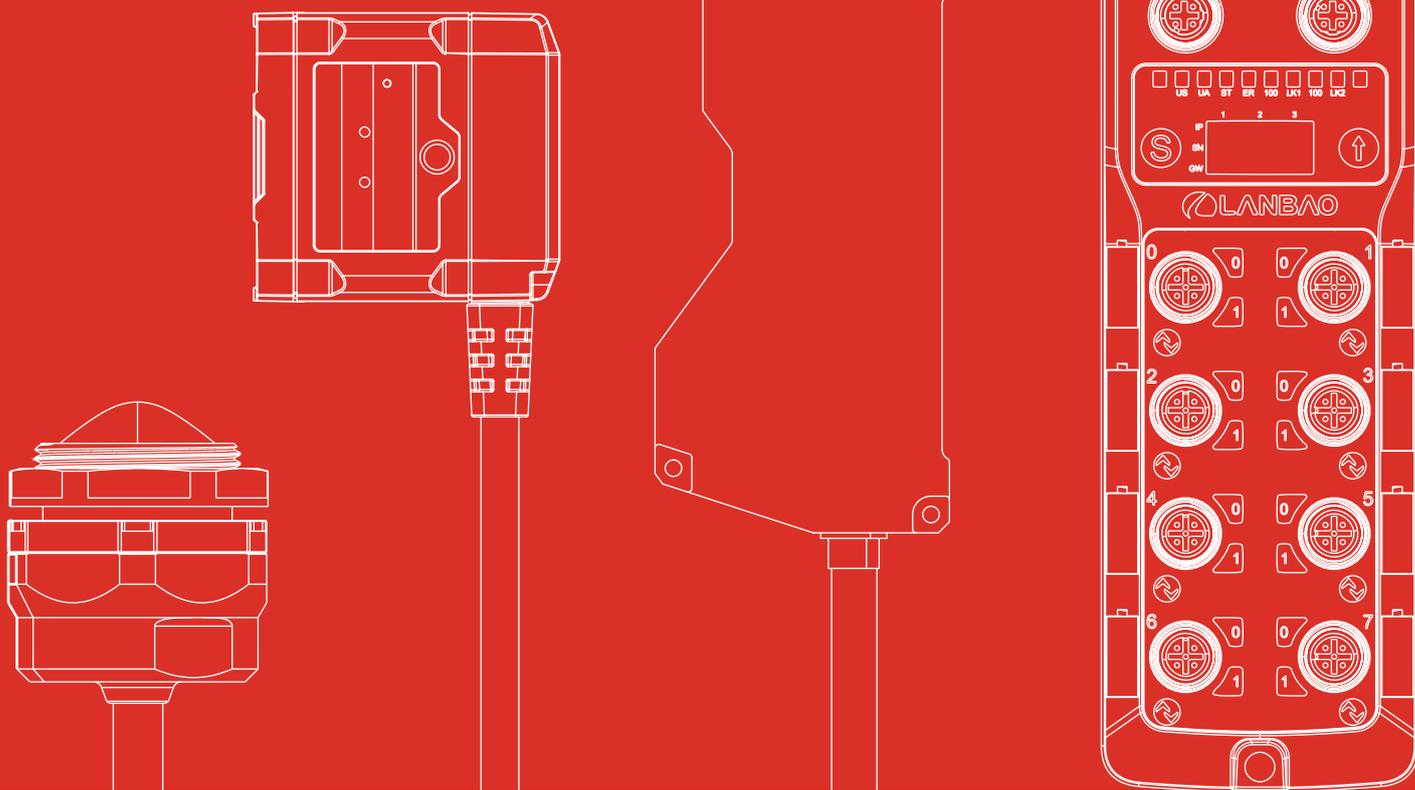



Sensing the Dream

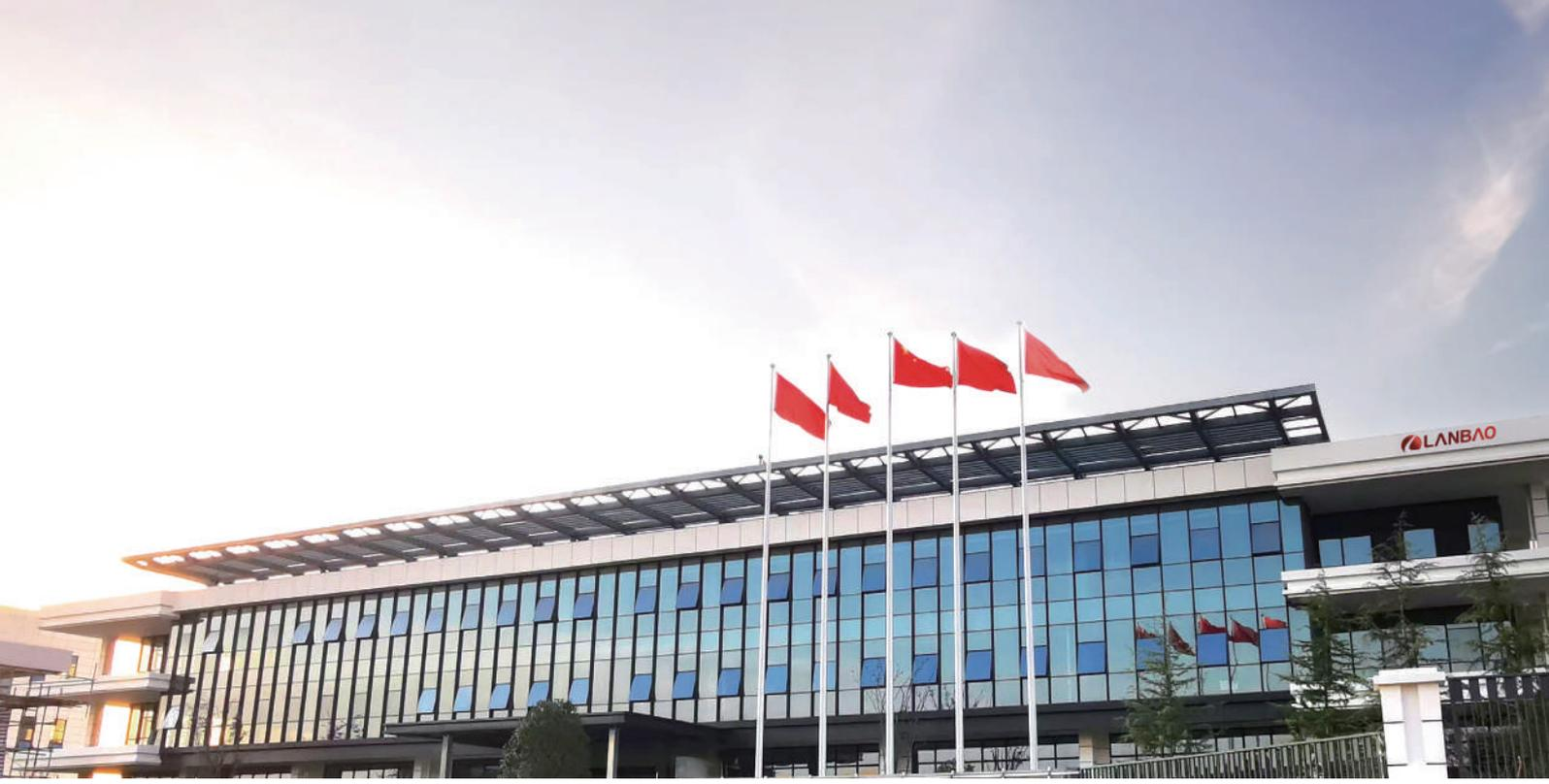

## About Us

---

Shanghai Lanbao Sensing Technology Co., Ltd., established in 1998, is a leading Chinese provider of industrial automation solutions. We specialize in developing innovative sensing technologies and systems, driving advancements in intelligent manufacturing. Our products are widely used across various industries, including electronics, automotive and energy, enhancing efficiency, safety and sustainability.

Lanbao offers a comprehensive range of sensors, including photoelectric, inductive, capacitive, laser, millimeter wave, ultrasonic and 3D laser measurement. Our solutions cater to diverse applications, from industrial robotics and automation to advanced manufacturing processes.

Recognized for our commitment to quality and innovation, Lanbao sensors are a preferred choice for replacing imported products, contributing to the localization of Chinese industrial automation sector.



**In 1998**  
Established



**360+**  
Patents and  
copyrights



**99,000m<sup>2</sup>**  
Factory



**120+**  
Countries and  
regions



**10,000+**  
Product  
models



**15,000,000**  
Pcs/year



# CORE PRODUCTS

---



Based on intelligent sensing technology, internet of things, cloud computing, big data, mobile internet and other advanced technologies, Lanbao improved the intelligence level of various products to help customers to transform their production modes from artificial to intelligent and digital. In this way, we're able to elevate the level of intelligent manufacturing to empower customers with high competitiveness.



## Inductive Sensors

---

- Standard function cylindrical series
- Standard function square series
- High protection series
- Temperature extended series
- Factor one series
- Welding immune series
- Extended distance series
- Full metal housing series
- Clamp position series
- Analog output series
- Self-diagnosis series
- Speed monitoring series
- NAMUR series
- High pressure resistant series
- Inductive distance measuring series



## Capacitive Sensors

---

- Standard function series
- Time delay function series
- Corrosion resistance detection series
- Extended sensing distance series
- High temperature material detection series
- Frequency enhanced series
- Tube liquid detection series



## Photoelectric Sensors

---

- Ultra thin series
- Little square series
- Round and square series
- Micro square series
- Large square series
- Cylindrical series
- Slot series
- Color series
- Color mark series
- Optical fiber series
- Label series

## Measurement and vision sensors



Laser distance measuring sensor  
PDA/PDB

OLED digital display, convenient operation, button/remote teach-in, multiple specifications available.



Laser displacement sensor  
PDA/PDB/PDE

OLED digital display, easy operation, small size with high precision, flexible output mode, multiple specifications available.



CCD Laser diameter measuring sensor  
PDT/PDM

Exquisite wide range, high precision, a variety of measurement modes, compatible with one-to-two, multi-controller cascading.



2D Laser scanner sensor  
PDL

High-performance lidar to meet multiple applications widely used in manufacturing, warehousing, logistics, medical and service robot industries.



LVDT displacement sensor  
LVR/LVA

Digital/analog/RS48 measurement accuracy reaches micron level.



Ultrasonic sensor  
UR12/18/30/US40

With features as anti-pollution, antidust, anti-moisture, and strong penetration ability, widely used in fields like liquid level monitoring, robot anti-collision, single and double sheet detection, etc.



Millimeter wave radar sensor  
MRA

Long-distance and high-precision ranging to meet micro-change monitoring in complex environments.



Code reader  
PID

Wide resolution coverage and multiple series to meet industrial-level information traceability needs.



3D line scan sensor  
PHM

In use of high-precision CMOS sensors and unique algorithms, with ultra high linear accuracy to realize non-contact and wear-free measurement.

# Sensing the Dream

## Safety and control

---



### Light curtain

SFB/SFE/SFG/SFN/SFS  
MH20/MH40

SFx series high-level safety protective light curtains are widely used in forging and stamping industries, automotive manufacturing, and electrical and electronics manufacturing industries. MHxx series measuring light curtains can measure the size of objects and are extensively used in product quality inspection and passing detection.



### Safety door switch

SLB-D/SLC-D/SLAS-D/SLD/  
Operation keys

Combining ease of use and reliability, with various sizes and contact points available for selection.



### Encoder

ENI38K/38S/50S/58K/58S  
ENA39S/58S

Applied to machine tool feed axes, servo motion control, and industrial robots, the encoder features high rigidity, high response, and high positioning accuracy.

## Industrial network module and connection system

---



### Industrial network module

Master/hub

Stable and reliable communication transmission, robust metal casing, excellent cost-performance ratio, aiding in the realization of Industry 4.0.



### Junction box

DB08/DB12

Consolidate multiple power and data signals, reducing the amount of wiring needed.



### Connection cable

QE8/QE12

Designed to connect various electronic devices for data transmission and power supply.



### Standard function cylindrical series

QE8/QE12

For circuit connections, making the design and production process more convenient and flexible.



# CONTENTS

01

## Inductive sensors

Standard function cylindrical series	A01-007
Standard function square series	A02-001
High protection series	A03-001
Temperature extended series	A04-001
Factor one series	A05-001
Welding immune series	A06-001
Extended distance series	A07-001
Full metal housing series	A08-001
Clamp position series	A09-001
Analog output series	A10-001
Self-diagnosis series	A11-001
Speed monitoring series	A12-001
NAMUR series	A13-001
High pressure resistant series	A14-001
Inductive distance measuring series	A15-001

02

## Capacitive sensors

Standard function cylindrical series	B01-005
Standard function square series	B02-001
Extended distance series	B03-001
Frequency enhanced series	B04-001
Corrosion resistant series	B05-001
Pipeline liquid level series	B06-001
High temperature material level series	B07-001

**03****Photoelectric sensors**

Ultra thin series	C01-005
Micro square series	C02-001
Little square series	C03-001
Large square series	C04-001
Round and square series	C05-001
Cylindrical series	C06-001
Slot series	C07-001
Optical fiber series	C08-001
Color series	C09-001
Color mark series	C10-001
Label series	C11-001

**04****Measurement and vision sensors**

Laser distance measurement series	D01-003
Laser displacement series	D02-001
CCD laser line diameter series	D03-002
2D laser radar series	D04-001
LVDT displacement series	D05-001
Ultrasonic series	D06-001
Millimeter wave radar series	D07-001
Code reader series	D08-001
3D laser line scanner series	D09-001

**05**

## **Safety and control system**

Light curtain	E01-003
Safety door switch	E02-001
Encoder	E03-001

**06**

## **Industrial network module and connection system**

IO-LINK	F01-003
Distribution boxes	F02-001
Connecting cables	F03-001
Connectors	F04-001

**07**

## **Sensor accessories**

Reflectors	Z01-001
Mounting bracket	Z02-001



# 01

## Inductive Sensors

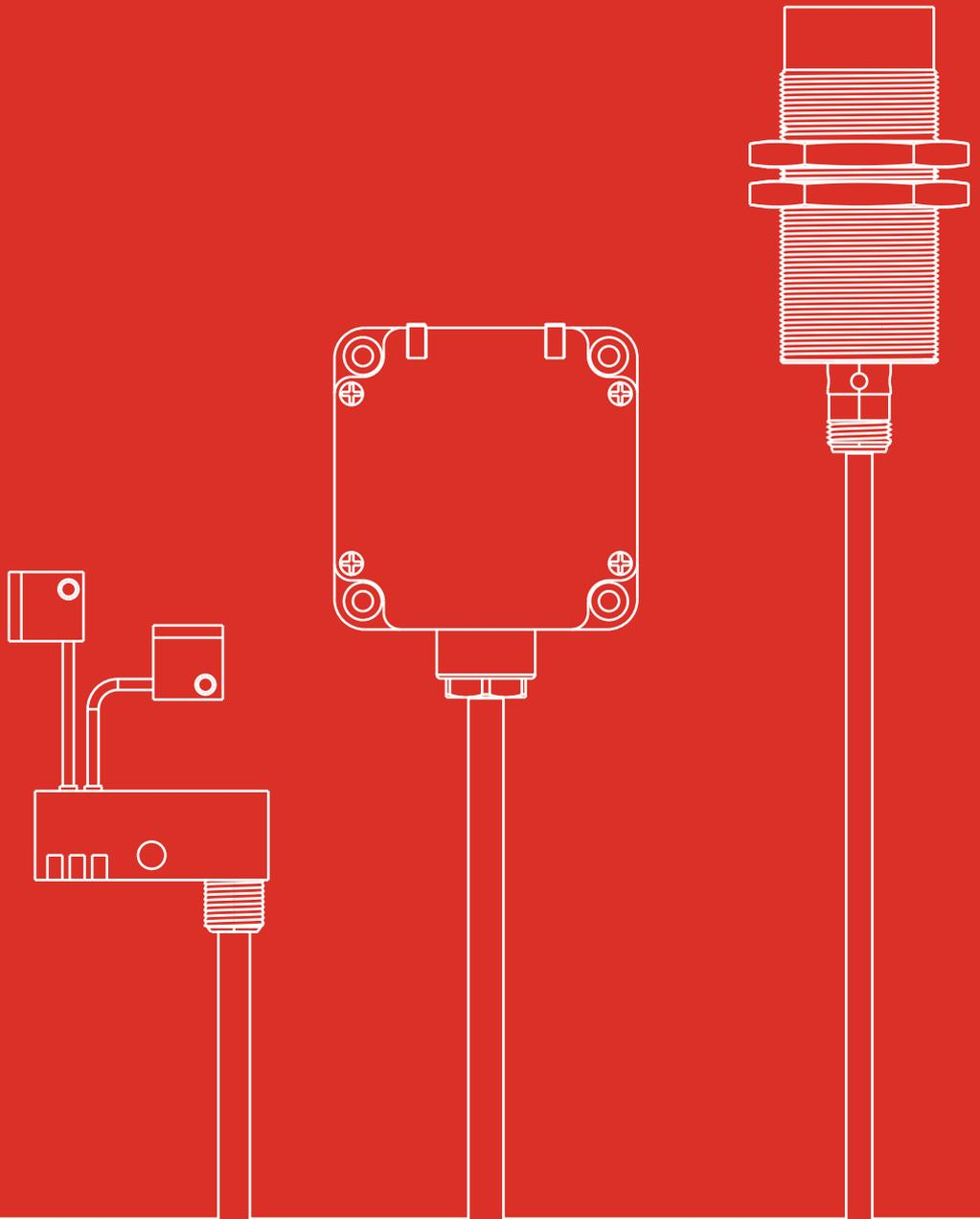

# Product Family

## Standard function cylindrical series

High-quality, cost-effective proximity sensors for general use in the industry.



A01-07

LR04/05/6.5  
08/12/18/30

## Standard function square series

High-quality, cost-effective proximity sensors for general use in the industry.



A02-01

LE05/08/08X/09/11/12/12X/15  
LE17/18/25/40SZ/40XZ/80

## High protection series

Applied to engineering machinery, port machinery and other industries, meeting the EMC standards for automotive industry.



A03-01

LR12E/18E/30E/LE40E

## Temperature extended series

Applied to harsh conditions, such as outdoors, metal foundry or glass industry.



A04-01

LR12/18/30-W/W1/W2/W3/W4  
LE40SZ/40XZ/80-W1/W2/W3

## Factor one series

Factor 1 for all metals, applied to automotive equipment, new energy etc.



A05-01

LR12/18/30-U

## Welding immune series

Applied to strong magnetic environments such as automotive equipment.



A06-01

LR12/18/30-A

## Extended distance series

Long sensing distance, easy target setting and space saving.



A07-01

LR12X/18X/30X-Y

## Full metal housing series

Applied to food, chemical and other special industries.



A08-01

LR12/18/30-Q

## Clamp position series

Dual-channel detection, widely used in automotive welding, clamping position etc.



A09-01

LT18/20-A

## Analog output series

Applied to displacement measurement, thickness measurement.



A10-01

LR12/18/30  
LE40SZ/XZ/80XZ -M

## Self-diagnosis series

Diagnostic output for sensor and feedback signal monitoring.



A11-01

LR12/18/LE25-Z

## Speed monitoring series

Widely used for equipment overspeed or low speed operation status monitoring.

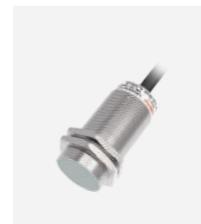

A12-01

LR18/30-J

## NAMUR series

Low voltage and low current design, applied to flammable and explosive fields such as textile, petroleum, chemical industry, etc.



**A13-01**

LR05/6.5/08  
12/18/30-N

## High pressure resistant series

Widely used in high hydraulic and high air pressure fields.



**A14-01**

LR10/12/14/16/18-B

## Inductive distance measuring series

The measurement accuracy is  $\pm 1\%$ , with switch output, +0-10V or 4-20mA.



**A15-01**

LR18XB/LR30XB-M/D



**1. Classification**

L: Inductive sensor

**2. Appearance code**

R: Threaded cylindrical  
 Q: Smooth cylindrical  
 E: Square  
 T: Combination

**3. Size code**

Number: 01...99mm

**4. Shape code**

V: Angular column  
 Z: Combination  
 SZ: Short combination type (40...80mm)  
 XZ: Long combination type (80...140mm)  
 X,E,F,...: Represents appearance

**5. Housing material**

Blank: Metal copper shell  
 G: Stainless steel  
 S: Plastic  
 V: Aluminium

**6. Housing size**

Blank: Square shell  
 A: Short  
 B: Standard  
 C: Long  
 D: Super long

**7. Mounting**

F: Flush  
 N: Non-flush

**8. Sensing distance**

01...100: 0...100mm  
 e.g. 01: 1mm

**9. Supply voltage**

A: 20...250V AC  
 B: 90...250V AC  
 D: 10...30V DC  
 H: 20...30V DC  
 L: 15...30V DC  
 S: 20...250V AC/DC  
 E: 10...60V DC  
 F: 8.2V DC

**10. Output logic**

Blank: Analog  
 N: NPN  
 P: PNP  
 B: AC/DC 2 wires  
 L: DC 2 wires  
 T: AC 2 wires

**11. Output status**

O: NO  
 C: NC  
 R: NO+NC  
 B: NO/NC Optional  
 I: Current (0...20mA)  
 I4: Current (4...20mA)  
 IU: Coltage+current (0...10V, 0...20mA)  
 U: Voltage (0...10V)  
 L: IO-Link

**12. Switch function**

Blank: Standard function  
 D: Analog voltage output  
 N: NAMUR  
 W: Wide temperature (-25°C...120°C)  
 W1: Wide temperature (-40°C...70°C)  
 W2: Wide temperature (-25°C...100°C)  
 W3: Wide temperature (-40°C...85°C)  
 W4: Wide temperature (-25°C...180°C)  
 B: High pressure resistant  
 Y: Extended distance  
 Z: Self-diagnosis  
 Q: Full metal housing  
 G: Enhanced frequency  
 J: Speed monitoring  
 A: Welding immune  
 U: Factor one

**13. Connection**

Blank: Cable  
 E1: M8 3-pins connector  
 E2: M12 4-pins connector  
 E3: M8 4-pins connector  
 E5: M12 5-pins connector  
 Fx: Cable+connector (x: Number)  
 D: Terminal

**14. Special requirement**

4 Digits or letters

- Standard cylindrical
- Standard square
- High protection
- Temperature extended
- Factor one
- Welding immune
- Extended distance
- Full metal housing
- Clamp position
- Analog output
- Self-diagnosis
- Speed monitoring
- NAMUR
- High pressure resistant
- Inductive distance measuring





# Quick Selection

Inductive

Series	Shape Detection distance	Moun- ting	Cylindrical						Square				
			LR04	LR05	LR6.5	LR08	LR12	LR18	LR30	LE17/18	LE25	LE40SZ/XZ	LE80XZ
Standard function	F		0.8/1.5	0.8/1.5	1.5/2	1.5/2	2/4	5/8	10/15	5	7	15/20	40/50
	NF				2/4	2/4	4/8	8/12	15/22	8	10	20/40	50/70
High protection	F					4	8	15					
	NF					8	12	22					
Temperature extended	F					2	5	10			15	40	
	NF					4	8	15			20	50	
Factor one	F					4	8	15					
	NF					8	12	22					
Welding immune	F					4	8	15					
	NF					8	12	22					
Extended distance	F					6	12	22					
	NF					10	20	40					
Full metal housing	F					2	5	10					
	NF					2	8	15					

Series	Shape Detection distance	Moun- ting	Square							
			LE05	LE08/X	LE09	LE11	LE12	LE12X	LE15	
Square	F		0.8							5
	NF			2.5	2.5	3	4/6	4		8

Series	Shape Detection distance	Moun- ting	Square								
			LE81/2	LE10	LE16	LE20	LE30	LE36	LE40	LE50	LE68
Customizable	F		1.5	5	2	5	10	5	15	5	15
	NF			8	4	8	15	8	20	8	25

Series	Model Detection distance	Moun- ting	LT18				LT20				
			Clamp position	NF							

Series	Shape Detection distance	Moun- ting	Cylindrical			Square	
			LR12	LR18	LR30	LE40SZ/XZ	LE80XZ
Analog output	F		2	5	10	10	40
	NF		4	8	15	15	50

Series	Shape Detection distance	Moun- ting	Cylindrical					Square
			LR05	LR6.5	LR08	LR12	LR18	LR30
Self-diagnosis	F					3.7		
	NF					8	12	8
Speed monitoring	F					5	10	
	NF					8	15	
Namur	F		0.8	1.5	1.5	2	5	10
	NF			2	2	4	8	15

Standard cylindrical  
Standard square  
High protection

Temperature extended  
Factor one  
Welding immune

Extended distance  
Full metal housing

Clamp position  
Analog output

Self-diagnosis  
Speed monitoring  
NAMUR

High pressure resistant  
Inductive distance measuring

Naming rules



Official Website

Series	Shape Detection distance	Moun- ting	Cylindrical				
			LR10	LR12	LR14	LR16	LR18
High pressure resistant		F	0.8	1.5	1.5/3	2	2

Series	Shape Detection distance	Moun- ting	Cylindrical	
			LR18X	LR30X
Inductive distance measuring		NF	5	10
		NF	8	15

Unit:mm

- Standard cylindrical
- Standard square
- High protection
- Temperature extended
- Factor one
- Welding immune
- Extended distance
- Full metal housing
- Clamp position
- Analog output
- Self-diagnosis
- Speed monitoring
- NAMUR
- High pressure resistant
- Inductive distance measuring
- Naming rules



## Inductive Sensors

## Standard Function Cylindrical Series



For specifications, certification, usage and model list, please scan the product QR code.



## Standard cylindrical

Standard square

High protection

Temperature extended

Factor one

Welding immune

Extended distance

Full metal housing

Clamp position

Analog output

Self-diagnosis

Speed monitoring

NAMUR

High pressure resistant

Inductive distance measuring

Naming rules

## Product features

### Stable performance

Dedicated IC production, stable detection distance.

### Rich product specifications

Specifications range from  $\phi 4$  to M30, with various lengths available.

### Multiple connection modes

With cable, M8/M12 connector.

## Application

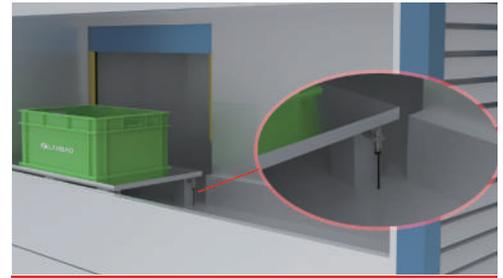

Container lifting



Official Website

## DC 3/4 wires

Appearance	Model	Dimension(mm)	Mounting	Sensing distance	Switching frequency	Housing material	Output	
	LR04Q	φ4*30, φ4*54	F	0.8mm	2000Hz	Stainless steel	NPN/PNP NO/NC	
			Quasi-flush	1.5mm	1200Hz			
	LR05	M5*0.5*30 M5*0.5*40	F	0.8mm	2000Hz			
			Quasi-flush	1.5mm	1200Hz			
	LR6.5Q	φ6.5*40, φ6.5*43 φ6.5*49, φ6.5*52	F	1.5mm	2000Hz			
			Quasi-flush	2mm	1000Hz			
			NF	2mm	1500Hz			
			NF	4mm	800Hz			
	LR08	M8*1*40, M8*1*43 M8*1*49, M8*1*52 M8*1*65, M8*1*68	F	1.5mm	2000Hz			Stainless steel Nickel copper alloy
			Quasi-flush	2mm	1000Hz			
			NF	2mm	1500Hz			
	LR12X	M12*1*51 M12*1*55 M12*1*63 M12*1*67	F	2mm	1500Hz/4000Hz	Nickel copper alloy		
			Quasi-flush	4mm	800Hz			
			NF	4mm	1000Hz/3000Hz			
			NF	8mm	500Hz			
	LR18X	M18*1*51.5 M18*1*59.5 M18*1*63 M18*1*71	F	5mm	1000Hz/2000Hz			
			Quasi-flush	8mm	400Hz			
			NF	8mm	800Hz/1500Hz			
			NF	12mm	200Hz			
	LR30X	M30*1.5*52 M30*1.5*64 M30*1.5*63 M30*1.5*75	F	10mm	500Hz			
			Quasi-flush	15mm	300Hz			
			NF	15mm	300Hz			
			NF	22mm	150Hz			

Note: 1. The repeated accuracy of this series is  $\leq 3\%$ ; the supply voltage is 10...30V DC.  
2. For more information, please contact Lanbao sales.

Inductive

Standard cylindrical

Standard square

High protection

Temperature extended

Factor one

Welding immune

Extended distance

Full metal housing

Clamp position

Analog output

Self-diagnosis

Speed monitoring

NAMUR

High pressure resistant

Inductive distance measuring

Naming rules



Official Website

## DC 2 wires

Appearance	Model	Dimension (mm)	Mounting	Sensing distance	Switching frequency	Repeated accuracy	Housing material	Output
	LR6.5Q	φ6.5*40, φ6.5*43 φ6.5*49, φ6.5*52	F	1.5mm	1000Hz	<3%	Stainless steel	NO/NC
			NF	2mm	800Hz	<3%		
	LR08	M8*1*40, M8*1*43 M8*1*49, M8*1*52 M8*1*65, M8*1*68	F	1.5mm	1000Hz	<3%	Stainless steel Nickel copper alloy	
			Quasi-flush	2mm	1000Hz	<5%		
			NF	2mm	800Hz	<3%		
	LR12X	M12*1*51 M12*1*55 M12*1*63 M12*1*67	F	2mm	800Hz	<3%	Nickel copper alloy	
			Quasi-flush	4mm	800Hz	<5%		
			NF	4mm	500Hz	<3%		
			Non-flush	8mm	500Hz	<5%		
	LR18X	M18*1*51.5 M18*1*59.5 M18*1*63 M18*1*71	F	5mm	500Hz	<3%	Nickel copper alloy	
			Quasi-flush	8mm	400Hz	<5%		
			NF	8mm	300Hz	<3%		
	LR30X	M30*1.5*52 M30*1.5*64 M30*1.5*63 M30*1.5*75	F	10mm	300Hz	<3%	Nickel copper alloy	
			Quasi-flush	15mm	300Hz	<5%		
			NF	15mm	200Hz	<3%		
			NF	22mm	150Hz	<5%		

Note: 1. The supply voltage for this series is 10...30V DC. 2. For more information, please contact Lanbao sales.

## AC/DC 2 wires

Appearance	Model	Dimension (mm)	Mounting	Sensing distance	Repeated accuracy	Housing material	Output
	LR12X	M12*1*51 M12*1*55 M12*1*63 M12*1*67	F	2mm	<3%	Nickel copper alloy	NO/NC
			Quasi-flush	4mm	<5%		
			NF	4mm	<3%		
			NF	8mm	<5%		
	LR18X	M18*1*51.5 M18*1*59.5 M18*1*63 M18*1*71	F	5mm	<3%		
			Quasi-flush	8mm	<5%		
			NF	8mm	<3%		
	LR30X	M30*1.5*52 M30*1.5*64 M30*1.5*63 M30*1.5*75	NF	12mm	<5%		
			F	10mm	<3%		
			Quasi-flush	15mm	<5%		
			NF	15mm	<3%		
			NF	22mm	<5%		

Note: 1. The switching frequency of this series is 20Hz; the supply voltage is 20...250V AC/DC.  
2. For more information, please contact Lanbao sales.



Inductive

Standard cylindrical

Standard square

High protection

Temperature extended

Factor one

Welding immune

Extended distance

Full metal housing

Clamp position

Analog output

Self-diagnosis

Speed monitoring

NAMUR

High pressure resistant

Inductive distance measuring

Naming rules



## Inductive Sensors

## Standard Function Square Series



For specifications, certification, usage and model list, please scan the product QR code.



Standard cylindrical

Standard square

## Product features

### Easy installation

Multiple installation direction optional.

### Reliable circuit design

With short circuit, reverse polarity and overload protection.

### Various dimensions

Product sizes range from LE05 to LE82.

## Application



Metal parts detection on assembly line

## Model specification

### DC 3/4 wires

Appearance	Model	Dimension(mm)	Mounting	Sensing distance	Switching frequency	Repeated accuracy	Housing material	Output
	LE05	25*5 *5	F	0.8mm	1800Hz	<3%	Aluminium alloy	NPN/PNP NO/NC
	LE81	40*8 *8	F	1.5mm	2000Hz	<3%		
	LE82	40*8 *8	F	1.5mm	2000Hz	<3%		
	LE08	7.5*8*23	F	2.5mm	1000Hz	<3%	PC	
	LE08X	7.5*8*23	F	2.5mm	1000Hz	<3%		

Note: 1. The supply voltage for this series is 10...30V DC.  
2. For more information, please contact Lanbao sales.



Official Website

High protection

Temperature extended

Factor one

Welding immune

Extended distance

Full metal housing

Clamp position

Analog output

Self-diagnosis

Speed monitoring

NAMUR

High pressure resistant

Inductive distance measuring

Naming rules

DC 3/4 wires

Appearance	Model	Dimension (mm)	Mounting	Sensing distance	Switching frequency	Repeated accuracy	Housing material	Output
	LE09	7.5*8*23	NF	2.5mm	1000Hz	<3%	PC	NPN/PNP NO/NC
	LE11	7*12*27	NF	3mm	1000Hz	<3%		
	LE12	7.1*12*27.8	NF	4mm	800Hz	<3%		
	LE12X	31.8*12.5*12	NF	4mm	800Hz	<3%		
	LE15	8*15*31.5	NF	5/8mm	500/300Hz	<5%		
	LE10	18*10*30	F	5mm	1000Hz	<3%	PBT	
			NF	8mm	800Hz	<3%		
	LE16	16*28*12	F	2mm	1000Hz	<3%		
			NF	4mm	800Hz	<3%		
	LE36	36*60*8	F	5mm	700Hz	<3%		
			NF	8mm	500Hz	<3%		
	LE50	25*10*50	F	5mm	700Hz	<3%		
			NF	8mm	500Hz	<3%		
	LE17	17*17*28	F	5mm	700Hz	<3%		
			NF	8mm	500Hz	<3%		
	LE18	18*18*35	F	5mm	700Hz	<3%		
			NF	8mm	500Hz	<3%		
	LE20	20*20*38	F	5mm	700Hz	<3%		
			NF	8mm	500Hz	<3%		
	LE25	25*25*39	F	7mm	700Hz	<3%		
			NF	10mm	500Hz	<3%		
	LE30	30*30*53	F	10mm	500Hz	<3%		
			NF	15mm	300Hz	<3%		
	LE40	40*40*53	F	15mm	400Hz	<3%		
			NF	20mm	200Hz	<3%		
	LE68	20*40*71 20*40*80	F	15mm	500Hz	<3%		
			Quasi-flush	22mm	200Hz	<5%		
			NF	25mm	300Hz	<3%		
	LE40E	40*40*54	F	20mm	300Hz	<5%	PC	
			NF	40mm	200Hz	<5%		
	LE40SZ	40*40*66	F	15mm	500Hz	<3%	PBT	
			Quasi-flush	20mm	200Hz	<5%		
			NF	20mm	300Hz	<3%		
			NF	40mm	200Hz	<5%		

Inductive

- Standard cylindrical
- Standard square**
- High protection
- Temperature extended
- Factor one
- Welding immune
- Extended distance
- Full metal housing
- Clamp position
- Analog output
- Self-diagnosis
- Speed monitoring
- NAMUR
- High pressure resistant
- Inductive distance measuring
- Naming rules

Note: 1. The supply voltage for this series is 10...30V DC.  
2. For more information, please contact Lanbao sales.





## DC 3/4 wires

Appearance	Model	Dimension (mm)	Mounting	Sensing distance	Switching frequency	Repeated accuracy	Housing material	Output
	LE40XZ	40*40*120 40*40*129	F	15mm	500Hz	<3%	PBT	NPN/PNP NO/NC
			Quasi-flush	20mm	200Hz	<5%		
			NF	20mm	300Hz	<3%		
			NF	40mm	200Hz	<5%		
	LE80XZ	40*80*98 40*80*104	F	40mm	80Hz	<3%		
			Quasi-flush	50mm	50Hz	<5%		
			NF	50mm	40Hz	<3%		
			NF	70mm	30Hz	<5%		
	LT18	47*18*35	NF	2mm	30Hz	<3%	PA66	
	LT20	47*18*28.5	NF	2mm	30Hz	<3%		

Note: 1. The repeated accuracy of this series is  $\leq 3\%$ ; the supply voltage is 10...30V DC.  
2. For more information, please contact Lanbao sales.

## DC 2 wires

Appearance	Model	Dimension (mm)	Mounting	Sensing distance	Switching frequency	Repeated accuracy	Housing material	Output
	LE05	25*5*5	F	0.8mm	1500Hz	<3%	Aluminium alloy	NO/NC
	LE36	36*60*8	F	5mm	500Hz	<3%	PBT	
			NF	8mm	500Hz	<3%		
	LE50	25*10*50	F	5mm	500Hz	<3%		
			NF	8mm	300Hz	<3%		
	LE17	17*17*28	F	5mm	500Hz	<3%		
			NF	8mm	300Hz	<3%		
	LE18	18*18*35	F	5mm	500Hz	<3%		
			NF	8mm	300Hz	<3%		
	LE20	20*20*38	F	5mm	500Hz	<3%		
			NF	8mm	300Hz	<3%		
	LE25	25*25*39	F	7mm	500Hz	<3%		
			NF	10mm	300Hz	<3%		
	LE30	30*30*53	F	10mm	500Hz	<3%		
			NF	15mm	300Hz	<3%		
	LE40	40*40*53	F	15mm	500Hz	<3%		
			NF	20mm	300Hz	<3%		
	LE68	20*40*71 20*40*80	F	15mm	500Hz	<3%		
			NF	22mm	200Hz	<3%		
			F	25mm	300Hz	<3%		

Note: 1. The repeated accuracy of this series is  $\leq 3\%$ ; the supply voltage is 10...30V DC.  
2. For more information, please contact Lanbao sales.

Standard cylindrical

Standard square

High protection

Temperature extended

Factor one

Welding immune

Extended distance

Full metal housing

Clamp position

Analog output

Self-diagnosis

Speed monitoring

NAMUR

High pressure resistant

Inductive distance measuring

Naming rules



Official Website

## DC 3/4 wires

Appearance	Model	Dimension (mm)	Mounting	Sensing distance	Switching frequency	Repeated accuracy	Housing material	Output
	LE40SZ	40*40*66	F	15mm	500Hz	<3%	PBT	NO/NC
			Quasi-flush	20mm	200Hz	<3%		
			NF	20mm	300Hz	<3%		
			NF	40mm	100Hz	<3%		
	LE40XZ	40*40*120 40*40*129	F	15mm	500Hz	<3%		
			Quasi-flush	20mm	200Hz	<3%		
			NF	20mm	300Hz	<3%		
			NF	40mm	100Hz	<3%		
	LE80XZ	40*80*98 40*80*104	F	40mm	80Hz	<3%		
			Quasi-flush	50mm	50Hz	<3%		
			NF	50mm	40Hz	<3%		
			NF	70mm	30Hz	<3%		

Note: 1. The supply voltage for this series is 10...30V DC.  
2. For more information, please contact Lanbao sales.

## AC/DC 2 wires

Appearance	Model	Dimension (mm)	Mounting	Sensing distance	Switching frequency	Repeated accuracy	Housing material	Output
	LE17	17*17*28	F	5mm	20Hz	<3%	PBT	NO/NC
			NF	8mm	20Hz	<3%		
	LE18	18*18*35	F	5mm	20Hz	<3%		
			NF	8mm	20Hz	<3%		
	LE20	20*20*38	F	5mm	20Hz	<3%		
			NF	8mm	20Hz	<3%		
	LE25	25*25*39	F	7mm	20Hz	<3%		
			NF	10mm	20Hz	<3%		
	LE30	30*30*53	F	10mm	20Hz	<3%		
			NF	15mm	20Hz	<3%		
	LE40	40*40*53	F	15mm	20Hz	<3%		
			NF	20mm	20Hz	<3%		
	LE50	25*10*50	F	5mm	20Hz	<3%		
			NF	8mm	20Hz	<3%		
	LE68	20*40*71 20*40*80	F	15mm	20Hz	<3%		
			NF	25mm	20Hz	<3%		
	LE40SZ	40*40*66	F	15mm	20Hz	<3%		
			NF	20mm	20Hz	<3%		
	LE40XZ	40*40*120 40*40*129	F	15mm	20Hz	<3%		
			NF	20mm	20Hz	<3%		
	LE80XZ	40*80*98 40*80*104	F	40mm	10Hz	<3%		
			NF	50mm	10Hz	<3%		

Note: 1. The supply voltage for this series is 20...250V AC/DC.  
2. For more information, please contact Lanbao sales.

Standard cylindrical

Standard square

High protection

Temperature extended

Factor one

Welding immune

Extended distance

Full metal housing

Clamp position

Analog output

Self-diagnosis

Speed monitoring

NAMUR

High pressure resistant

Inductive distance measuring

Naming rules



Official Website

## Inductive

## High Protection Series



Standard cylindrical

Standard square

High protection

Temperature extended

Factor one

Welding immune

Extended distance

Full metal housing

Clamp position

Analog output

Self-diagnosis

Speed monitoring

NAMUR

High pressure resistant

Inductive distance measuring

Naming rules

## Product features

## High protection degree

IP68, dustproof and waterproof.

## Wide temperature range

The temperature range can reach -40...85°C

## Strong anti-interference ability

Automotive-grade EMC environmental test.

## Application



Truck crane (cab return detection)

## Model specification

Appearance	Model	Dimension (mm)	Mounting	Sensing distance	Switching frequency	Housing material	Output
	LR12E	M12*48	F	4mm	800Hz	Nickel copper alloy	NPN/PNP NO/NC
			NF	8mm	500Hz		
	LR18E	M18*48	F	8mm	400Hz		
			NF	12mm	200Hz		
	LR30E	M30*48	F	15mm	300Hz		
			NF	22mm	150Hz		
	LE40E	40*40*54	F	20mm	200Hz	PC	
			NF	40mm	100Hz		

Note: 1. The temperature range for this series is -40...85°C, the repeated accuracy is  $\leq 5\%$ , the supply voltage is 10...30V DC.  
2. For more information, please contact Lanbao sales.



Official Website

Inductive

Standard cylindrical

Standard square

High protection

Temperature extended

Factor one

Welding immune

Extended distance

Full metal housing

Clamp position

Analog output

Self-diagnosis

Speed monitoring

NAMUR

High pressure resistant

Inductive distance measuring

Naming rules



## Inductive

## Temperature Extended Series



For specifications, certification, usage and model list, please scan the product QR code.



Standard cylindrical

Standard square

High protection

Temperature extended

Factor one

Welding immune

Extended distance

Full metal housing

Clamp position

Analog output

Self-diagnosis

Speed monitoring

NAMUR

High pressure resistant

Inductive distance measuring

Naming rules

## Product features

## Extreme temperature

Low temperature resistant series can reach  $-40^{\circ}\text{C}$ , high temperature resistant series can reach  $180^{\circ}\text{C}$ .

## High precision

Compensation circuit design, high-precision detection within wide temperature range, with a repeatability of  $\leq 3\%$ .

## Wide application environment

In harsh environments such as steel,metallurgy,and glass manufacturing.

## Application

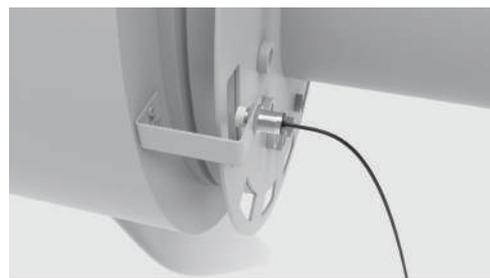

Internal position control of wind power equipment

## Model specification

Appearance	Model	Dimension (mm)	Mounting	Sensing distance	Switching frequency	Repeated Accuracy	Temperature range	Housing material
	LR12X-W	M12*1*51, M12*1*55 M12*1*63, M12*1*67	F	2mm	1500Hz	<5%	-25...120°C	Nickel copper alloy
			NF	4mm	1000Hz	<5%		
	LR18X-W	M18*1*51.5, M18*1*59.5 M18*1*63, M18*1*71	F	5mm	1000Hz	<5%	-25...120°C	
			NF	8mm	800Hz	<5%		
	LR30X-W	M30*1.5*52, M30*1.5*64 M30*1.5*63, M30*1.5*75	F	10mm	500Hz	<5%	-25...120°C	
			NF	15mm	300Hz	<5%		
	LE40SZ-W2	40*40*66	F	15mm	300Hz	<5%	-25...100°C	PBT
			NF	20mm	200Hz	<5%		
	LE40XZ-W2	40*40*120, 40*40*129	F	15mm	300Hz	<5%	-25...100°C	
			NF	20mm	200Hz	<5%		

Note: 1. The supply voltage of this series is 10...30V DC; the output mode is NPN/PNP NO/NC.  
2. For more information, please contact Lanbao sales.



Official Website

Appearance	Model	Dimension (mm)	Mounting	Sensing distance	Switching frequency	Repeated accuracy	Temperature range	Housing material
	LE80XZ-W2	40*80*98,40*80*104	F	40mm	100Hz	<5%	-25~100°C	PBT
			NF	50mm	50Hz	<5%		
	LR30X-W4	M30*1.5*52,M30*1.5*64 M30*1.5*63,M30*1.5*75	NF	15mm	100Hz	<5%	-25~180°C	Nickel copper alloy
	LR12X-W1	M12*1*51, M12*1*55 M12*1*63, M12*1*67	F	2mm	1500Hz	<3%	-40~70°C	
			NF	4mm	1000Hz	<3%		
	LR18X-W1	M18*1*51.5, M18*1*59.5 M18*1*63, M18*1*71	F	5mm	1000Hz	<3%	-40~70°C	
			NF	8mm	800Hz	<3%		
	LR30X-W1	M30*1.5*52, M30*1.5*64 M30*1.5*63, M30*1.5*75	F	10mm	500Hz	<3%	-40~70°C	
			NF	15mm	300Hz	<3%		
	LE40SZ-W1	40*40*66	F	15mm	300Hz	<3%	-40~70°C	PBT
			NF	20mm	200Hz	<3%		
	LE40XZ-W1	40*40*120, 40*40*129	F	15mm	300Hz	<3%	-40~70°C	
			NF	20mm	200Hz	<3%		

Note: 1. The supply voltage of this series is 10...30V DC; the output mode is NPN/PNP NO/NC.  
2. For more information, please contact Lanbao sales.

Inductive

Standard cylindrical

Standard square

High protection

Temperature extended

Factor one

Welding immune

Extended distance

Full metal housing

Clamp position

Analog output

Self-diagnosis

Speed monitoring

NAMUR

High pressure resistant

Inductive distance measuring

Naming rules



Official Website

## Inductive

## Factor One Series



Standard cylindrical

Standard square

High protection

Temperature extended

Factor one

Welding immune

Extended distance

Full metal housing

Clamp position

Analog output

Self-diagnosis

Speed monitoring

NAMUR

High pressure resistant

Inductive distance measuring

Naming rules

## Product features

## No attenuation detection

Factor 1 for all metals.

## Wide range of applications

Supports detection of various metal materials to meet different industrial needs.

## Strong anti-interference ability

Resistant to strong magnetic field interference, passing EMC temperature test.

## Application

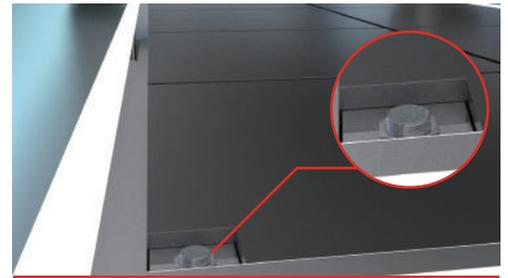

Car battery swap station chassis positioning detection

## Model specification

Appearance	Model	Dimension (mm)	Mounting	Sensing distance	Switching frequency	Housing material	Output
	LR12X-U	M12*1*51,M12*1*55 M12*1*63,M12*1*67	F	4mm	800Hz	Nickel copper alloy	NPN/PNP NO/NC
			NF	8mm	500Hz		
	LR18X-U	M18*1*51.5,M18*1*59*5 M18*1*63,M18*1*71	F	8mm	500Hz		
			NF	12mm	200Hz		
	LR30X-U	M30*1.5*52,M30*1.5*64 M30*1.5*63,M30*1.5*75	F	15mm	300Hz		
			NF	22mm	150Hz		

Note: 1. The repeated accuracy of this series is  $\leq 3\%$ ; the supply voltage is 10...30V DC.  
2. For more information, please contact Lanbao sales.



# Welding Immune Series



## Product features

### Anti-welding slag

High-quality teflon material to effectively prevent welding slag from sticking.

### High resistance to magnetic field interference

With  $\geq 100\text{mT}$  anti-magnetic field interference capability, suitable for strong magnetic field environments such as welding.

### Wide operating temperature range

The operating temperature range is extended to  $-40\sim 70^{\circ}\text{C}$ , adapting to various extreme environments.

## Application

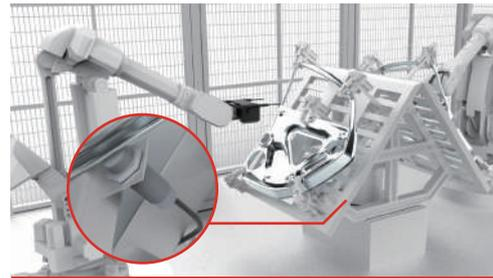

Door welding inspection

## Model specification

Appearance	Model	Dimension (mm)	Mounting	Sensing distance	Switching frequency	Housing material	Output	
	LR12X-A	M12*1*51,M12*1*55 M12*1*63,M12*1*67	Flush	4mm	800Hz	Brass+PTFE coating	NPN/PNP NO/NC	
			Non-flush	8mm	500Hz			
	LR18X-A	M18*1*51.5,M18*1*59.5 M18*1*63,M18*1*71	Flush	8mm	500Hz			
			Non-flush	12mm	200Hz			
	LR30X-A	M30*1.5*52,M30*1.5*64 M30*1.5*63,M30*1.5*75	Flush	15mm	300Hz			
			Non-flush	22mm	150Hz			
	LE21-A	26.2*20.2*10.5	Flush	0.3mm	500Hz			PA66

Note: 1. The repeated accuracy of this series is  $\leq 3\%$ ; the supply voltage is 10...30V DC.  
2. For more information, please contact Lanbao sales.

- Standard cylindrical
- Standard square
- High protection
- Temperature extended
- Factor one
- Welding immune
- Extended distance
- Full metal housing
- Clamp position
- Analog output
- Self-diagnosis
- Speed monitoring
- NAMUR
- High pressure resistant
- Inductive distance measuring
- Naming rules





## Inductive

## Extended Distance Series



## Product features

- Ultra-long detection range

3 times the detection distance, up to 40mm.

- Stable performance

## Application

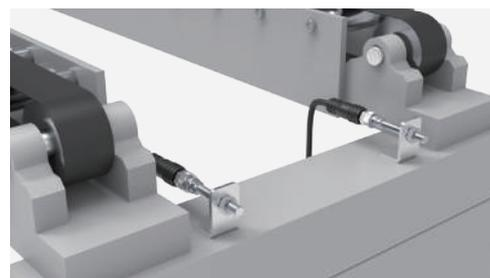

Battery shell position detection

## Model specification

Appearance	Model	Dimension (mm)	Mounting	Sensing distance	Switching frequency	Housing material	Output
	LR12X-Y	M12*1*51,M12*1*55,M12*1*63,M12*1*67 M12*1*61,M12*1*65,M12*1*73,M12*1*77	F	6mm	500Hz	Nickel copper alloy	NPN/PNP NO/NC
			NF	10mm	300Hz		
	LR18X-Y	M18*1*51.5,M18*1*59.5,M18*1*63,M18*1*71 M18*1*61.5,M18*1*69.5,M18*1*73,M18*1*81	F	12mm	300Hz		
			NF	20mm	150Hz		
	LR30X-Y	M30*1.5*52,M30*1.5*64,M30*1.5*63,M30*1.5*75 M30*1.5*62,M30*1.5*74,M30*1.5*73,M30*1.5*85	F	22mm	100Hz		
			NF	40mm	50Hz		

Note: 1. The repeated accuracy of this series is  $\leq 3\%$ ; the supply voltage is 10...30V DC.  
2. For more information, please contact Lanbao sales.

Standard cylindrical  
Standard square  
High protection  
Temperature extended  
Factor one  
Welding immune

**Extended distance**

Full metal housing  
Clamp position  
Analog output  
Self-diagnosis

Speed monitoring  
NAMUR

High pressure resistant

Inductive distance measuring

Naming rules



# Full Metal Housing Series



## Product features

### Sturdy and durable

Full 316L stainless steel design, significantly increase service life.

### Stronger torque resistance

Thick and strong housing can withstand greater torque and avoid loosening due to vibration or impact.

### Good stability

Integrated design of stainless steel material, more reliable and corrosion-resistant.

## Application



Double position detection of valve blocks

## Model specification

Appearance	Model	Dimension (mm)	Mounting	Sensing distance	Switching frequency	Repeated accuracy	Housing material	Output
	LR12X-Q	M12*1*74	F	2mm	100Hz	≤3%	316L stainless steel	NPN/PNP NO/NC
			NF	4mm	100Hz	≤3%		
	LR18X-Q	M18*1*74	F	5mm	50Hz	≤3%		
			NF	8mm	50Hz	≤3%		
	LR30X-Q	M30*1*74	F	10mm	50Hz	≤5%		
			NF	15mm	25Hz	≤5%		

Note: 1. The supply voltage for this series is 10...30V DC.  
2. For more information, please contact Lanbao sales.

- Standard cylindrical
- Standard square
- High protection
- Temperature extended
- Factor one
- Welding immune
- Extended distance
- Full metal housing**
- Clamp position
- Analog output
- Self-diagnosis
- Speed monitoring
- NAMUR
- High pressure resistant
- Inductive distance measuring
- Naming rules



## Inductive

## Clamp Position Series



For specifications, certification, usage and model list, please scan the product QR code.



## Product features

### Accurate detection

2-way detection head, dual logic output, accurate detection of clamp movement position.

### Anti-magnetic interference

Anti-magnetic interference  $\geq 100\text{mT}$ , used in strong magnetic environments such as welding.

### Flexible installation

The plug-in head can be rotated  $0^\circ$ ,  $45^\circ$ , and  $90^\circ$ , allowing flexible wiring.

### Visible working status

Use red, green and orange indicator lights.

## Application

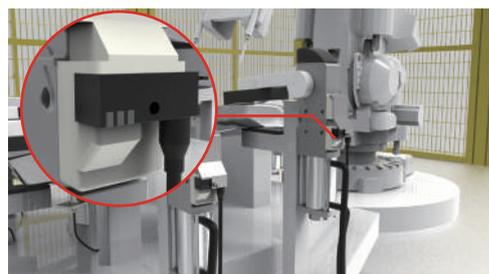

Clamp position detection

## Model specification

Appearance	Model	Dimension (mm)	Mounting	Sensing distance	Repeated accuracy	Switching frequency	Housing material	Output
	LT18-A	47*18*35	NF	2mm	0...1.6mm	30Hz	PA66	PNP NO
	LT20-A	47*18*28.5	NF	2mm	0...1.6mm	1000Hz		

Note: 1. The repeated accuracy of this series is  $\leq 3\%$ ; the supply voltage is 10...30V DC.  
2. For more information, please contact Lanbao sales.

Standard cylindrical  
Standard square  
High protection  
Temperature extended  
Factor one  
Welding immune  
Extended distance  
Full metal housing

## Clamp position

Analog output  
Self-diagnosis  
Speed monitoring  
NAMUR  
High pressure resistant  
Inductive distance measuring

Naming rules



Official Website

Inductive

Standard cylindrical

Standard square

High protection

Temperature extended

Factor one

Welding immune

Extended distance

Full metal housing

**Clamp position**

Analog output

Self-diagnosis

Speed monitoring

NAMUR

High pressure resistant

Inductive distance measuring

Naming rules



## Inductive

## Analog Output Series



For specifications, certification, usage and model list, please scan the product QR code.



## Product features

### Various output methods

0...10V, 0...20mA, 4...20mA, 0...10V+0...20mA optional.

### Good stability

High repeatability, stable and reliable.

## Application

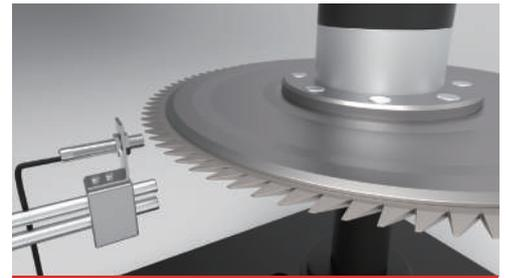

Saw blade position detection

## Model specification

### Square

Appearance	Model	Dimension (mm)	Mounting	Sensing distance	Response time	Housing material	Output
	LR12X-M	M12*1*61, M12*1*65 M12*1*73, M12*1*77	F	2mm	5ms	Nickel copper alloy	0-10V, 0-20mA, 4-20mA, 0...10V+0...20mA optional
			NF	4mm	10ms		
	LR18X-M	M18*1*61.5, M18*1*69.5 M18*1*73, M18*1*81	F	5mm	5ms		
			NF	8mm	10ms		
	LR30X-M	M30*1.5*62, M30*1.5*74 M30*1.5*73, M30*1.5*85	F	10mm	5ms		
			NF	15mm	10ms		

Note: 1. The linear accuracy of this series is  $\leq \pm 5\%$ ; the supply voltage is 15...30V DC.  
2. For more information, please contact Lanbao sales.

Standard cylindrical  
Standard square  
High protection  
Temperature extended  
Factor one  
Welding immune  
Extended distance  
Full metal housing  
Clamp position

## Analog output

Self-diagnosis  
Speed monitoring  
Namur

High pressure resistant

Inductive distance measuring

Naming rules



Official Website

## Square

Appearance	Model	Dimension (mm)	Mounting	Sensing distance	Response time	Housing material	Output
	LE40SZ-M	40*40*66	F	15mm	10ms	PBT	0...10V/0...20mA 4...20mA 0...10V+0...20mA optional
			NF	20mm	20ms		
	LE40XZ-M	40*40*120 40*40*129	F	15mm	10ms		
			NF	20mm	20ms		
	LE80XZ-M	40*80*98 40*80*104	F	40mm	12.5ms		
			NF	50mm	25ms		

Note: 1. The linear accuracy of this series is  $\leq \pm 5\%$ ; the supply voltage is 15...30V DC.  
2. For more information, please contact Lanbao sales.

# Inductive

Standard cylindrical

Standard square

High protection

Temperature extended

Factor one

Welding immune

Extended distance

Full metal housing

Clamp position

**Analog output**

Self-diagnosis

Speed monitoring

NAMUR

High pressure resistant

Inductive distance measuring

Naming rules



Official Website

## Inductive

## Self-Diagnosis Series



For specifications, certification, usage and model list, please scan the product QR code.



Standard cylindrical

Standard square

High protection

Temperature extended

Factor one

Welding immune

Extended distance

Full metal housing

Clamp position

Analog output

Self-diagnosis

Speed monitoring

NAMUR

High pressure resistant

Inductive distance measuring

Naming rules

## Product features

### Intelligent self-diagnosis, fault warning

Fault prediction to ensure production efficiency.

### Various output methods

With PNP/NPN NO/NC+HERAT etc.

## Application



Tobacco machine equipment operation detection

## Model specification

Appearance	Model	Dimension (mm)	Mounting	Sensing distance	Switching frequency	Supply voltage	Housing material	Output
	LR12X	M12*59	F	3.7mm	300HZ	20...30V DC	Nickel copper alloy	NPN/PNP NO/NC +HEART signal
			NF	8mm	500HZ	10...30V DC		
	LR18X	M18*59.5	NF	12mm	200HZ	10...30V DC		
	LE25-Z	25*25*42	NF	6.4mm	500HZ	10...30V DC	PBT	PNP NO+HEART signal

Note: 1. The linear accuracy of this series is  $\leq \pm 5\%$ ;  
2. For more information, please contact Lanbao sales.



Official Website

# Speed Monitoring Series



For specifications, certification, usage and model list, please scan the product QR code.



## Product features

### High-precision speed measurement

Using the principle of electromagnetic induction to achieve high-precision speed measurement.

### Real-time monitoring and feedback

Able to monitor the speed changes of rotating equipment in real time and provide instant feedback.

### Strong anti-interference ability

Effectively resist external electromagnetic interference to ensure stable operation in complex environments.

## Application



Cotton spinning machine speed detection

## Model specification

Appearance	Model	Dimension (mm)	Mounting	Sensing distance	Monitoring pulse (times/min)	Supply voltage	Housing material	Output
	LR18X-J	M18*1*61.5 M18*1*69.5	F	5mm	3...3000(adjustable)	10...30V DC	Nickel copper alloy	NPN/PNP NC
			NF	8mm	3...3000 (adjustable)			
	LR30X-J	M30*1.5*62 M30*1.5*74	F	10mm	3...3000 (adjustable)			
			NF	15mm	3...3000 (adjustable)			
	LR18X-J	M18*1*61.5 M18*1*69.5	F	5mm	3...1200 (adjustable)	20...250V AC	Nickel copper alloy	NC
			NF	8mm	3...1200 (adjustable)			
	LR30X-J	M30*1.5*62 M30*1.5*74	F	10mm	3...1200 (adjustable)			
			NF	15mm	3...1200 (adjustable)			

Note: 1. The repeated accuracy of this series is ≤3%.  
2. For more information, please contact with Lanbao sales.

- Standard cylindrical
- Standard square
- High protection
- Temperature extended
- Factor one
- Welding immune
- Extended distance
- Full metal housing
- Clamp position
- Analog output
- Self-diagnosis

**Speed monitoring**

- NAMUR
- High pressure resistant
- Inductive distance measuring
- Naming rules





# Inductive

## NAMUR Series



For specifications, certification, usage and model list, please scan the product QR code.



### Product features

#### High security

Applicable to flammable and explosive environments to ensure production safety.

#### High reliability

Multiple circuit protections, stable and reliable output signals.

### Application



Flower Pot Assembly Line - Loading and Firing Nitre Operation

### Model specification

Appearance	Model	Dimension (mm)	Mounting	Sensing distance	Switching frequency	Housing material	Output
	LR05	M5*30	F	0.8mm	3000Hz	Stainless Steel	NAMUR
	LR6.5Q	φ6.5*22, φ6.5*25	F	1.5mm	2500Hz		
			NF	2mm	2000Hz		
	LR08	M8*22, M8*25	F	1.5mm	2500Hz		
			NF	2mm	2000Hz	Nickel copper alloy	
	LR12X	M12*31, M12*35	F	2mm	2000Hz		
			NF	4mm	1500Hz		

Note: 1. The repeated accuracy of this series is ≤3%; the supply voltage is 8.2V DC.  
 2. For more information, please contact Lanbao sales.

- Standard cylindrical
- Standard square
- High protection
- Temperature extended
- Factor one
- Welding immune
- Extended distance
- Full metal housing
- Clamp position
- Analog output
- Self-diagnosis
- Speed monitoring

#### NAMUR

- High pressure resistant
- Inductive distance measuring
- Naming rules



Appearance	Model	Dimension (mm)	Mounting	Sensing distance	Switching frequency	Housing material	Output
	LR18X	M18*31.5, M18*39.5	F	5mm	1500Hz	Nickel copper alloy	NAMUR
			NF	8mm	1000Hz		
	LR30X	M30*32, M30*44	F	10mm	1000Hz		
			NF	15mm	800Hz		

Note: 1. The repeated accuracy of this series is  $\leq 3\%$ ; the supply voltage is 8.2V DC.  
 2. For more information, please contact Lanbao sales.

Inductive

- Standard cylindrical
- Standard square
- High protection
- Temperature extended
- Factor one
- Welding immune
- Extended distance
- Full metal housing
- Clamp position
- Analog output
- Self-diagnosis
- Speed monitoring
- NAMUR**
- High pressure resistant
- Inductive distance measuring
- Naming rules



## Inductive

## High Pressure Resistant Series



For specifications, certification, usage and model list, please scan the product QR code.



## Product features

### High voltage resistance design

Designed for high pressure environments, can withstand 500 bar pressure.

### High protection

IP68 protection degree.

### Sturdy and durable

Adopting integrated stainless steel shell material, the overall structure is more solid.

## Application

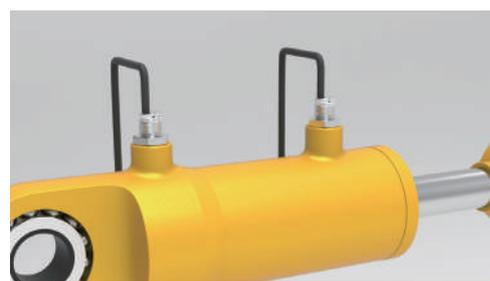

Piston position detection in the cylinder

## Model specification

Appearance	Model	Dimension (mm)	Mounting	Sensing distance	Switching frequency	Withstand pressure	Housing material	Output
	LR10A-B	M10*35	F	0.8mm	600Hz	500bar	Stainless Steel	NPN/PNP NO/NC
	LR12X-B	M12*1*62,M12*1*77	F	1.5mm	600Hz	500bar		
	LR14X-B	M14*1*54,M14*1*64	F	1.5mm	600Hz	500bar		
			F	3mm	400Hz	500bar		
	LR16-B	M16*1*63,M16*1*73	F	2mm	600Hz	500bar		
	LR18-B	M18*1*58,M18*1*74	F	2mm	200Hz	500bar		

Note: 1. The repeated accuracy of this series is  $\leq 5\%$ ; the supply voltage is 10...30V DC.  
2. For more information, please contact Lanbao sales.

Standard cylindrical  
Standard square  
High protection  
Temperature extended  
Factor one  
Welding immune  
Extended distance  
Full metal housing  
Clamp position  
Analog output  
Self-diagnosis  
Speed monitoring  
NAMUR

High pressure resistant

Inductive distance measuring

Naming rules



Official Website

# Inductive Distance Measuring Series



## Product features

### High precision

The measurement accuracy reaches  $\pm 1\%$ , accurately reflecting subtle changes and providing reliable data.

### High stability

Repeated accuracy and linear accuracy can reach  $\pm 1\%$ , which is stable and reliable for long-term use.

### Various output methods

With 4-20mA, 0-10V+ and digital signal output.

## Application

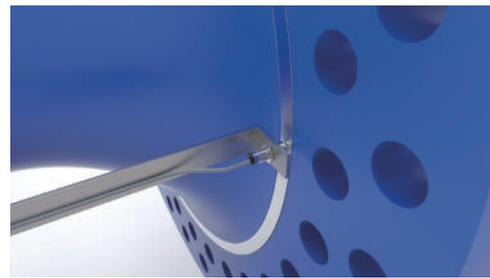

Wind turbine hub rotation stability detection

## Model specification

Appearance	Model	Dimension (mm)	Mounting	Sensing distance	Linear accuracy	Housing material	Output
	LR18XB-M	M18*1*60 M18*1*65	F	0.5-5mm	$\pm 1\%$	Nickel copper alloy	4~20mA+Digital output
			NF	0.8-8mm	$\pm 1\%$		
	LR30XB-M	M30*1.5*60 M30*1.5*65	F	1-10mm	$\pm 1\%$		
			NF	1-15mm	$\pm 1\%$		
	LR18XB-D	M18*1*60 M18*1*65	F	0.5-5mm	$\pm 1\%$	Nickel copper alloy	0~10V+Digital output
			NF	0.8-8mm	$\pm 1\%$		
	LR30XB-D	M30*1.5*60 M30*1.5*65	F	1-10mm	$\pm 1\%$		
			NF	1-15mm	$\pm 1\%$		

Note: 1. These series are with 300Hz frequency,  $\pm 1\%$  F.S. repeat accuracy and 18...30V DC power supply voltage.  
2. For more information, please contact with Lanbao sales.

- Standard cylindrical
- Standard square
- High protection
- Temperature extended
- Factor one
- Welding immune
- Extended distance
- Full metal housing
- Clamp position
- Analog output
- Self-diagnosis
- Speed monitoring
- Namur
- High pressure resistant

Inductive distance measuring

Naming rules



# 02

## Capacitive Seneors

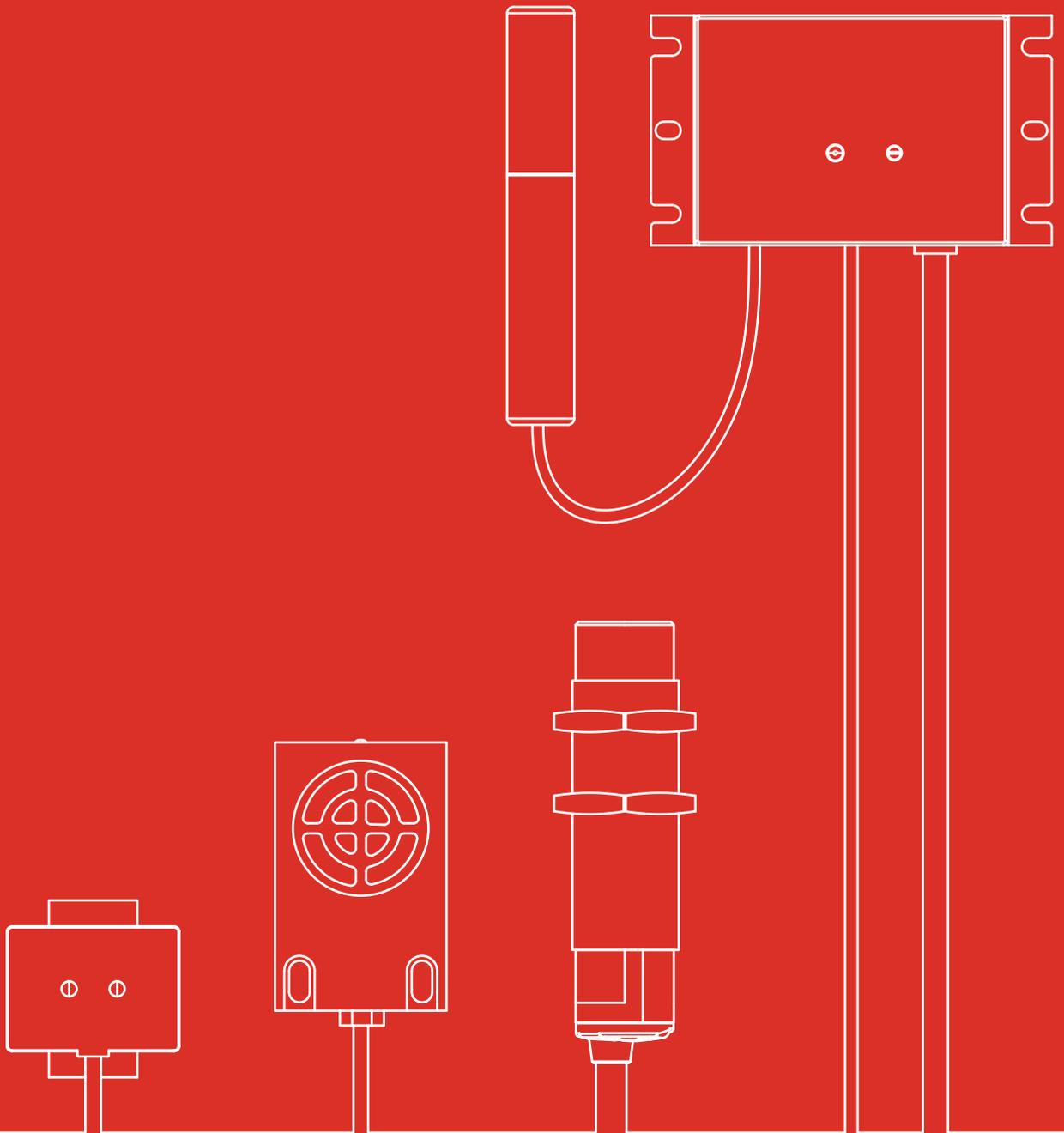

# Product Family

---

## Standard cylindrical series

Universal shape design, adjustable sensitivity.



**B01-005** CR12/18/30  
CQ20/32/34

## Standard flat series

Minimum 5mm ultra-thin shape.



**B02-001** CE05S/05XS  
07S/34S/35S/39S

## Extended sensing distance series

Longer detection distance, adjustable sensitivity.



**B03-001** CR12/18/30

## Frequency enhanced series

Frequency >100Hz.



**B04-001** CR12/18  
CE05S/05XS/16S/17S/34S

## Corrosion resistant series

Suitable for acid-base environment.



**B05-001** CR18XT

## Pipe liquid level series

C shape surface design.



**B06-001** CE10S/15S

## High temperature resistant material level series

Apply to high temperature environment such as dispensing equipment.



**B07-001** CE10S/15S

C R 18 X S C F 05 D P O □ \_ □ □  
 ① ② ③ ④ ⑤ ⑥ ⑦ ⑧ ⑨ ⑩ ⑪ ⑫ ⑬ ⑭

**1. Classification**

C: Capacitive sensor

**2. Appearance code**

R: Threaded cylindrical

Q: Smooth cylindrical

E: Square

**3. Size code**

Number: 01...99mm

**4. Shape code**

Blank: Cylindrical

X: Appearance improved/  
function enhanced products**5. Housing material**

Blank: Metal copper

G: Stainless steel

S: Plastic

T: Teflon

**6. Housing size**

Blank: Square shell

A: Short

B: Standard

C: Long

D: Extra long

**7. Mounting**

F: Flush

N: Non-flush

**8. Sensing distance**

01...99: 1...99mm

e.g. 02: 2mm

**9. Supply voltage**

A: 20...250V AC

D: 10...30V DC

M: 18...36V DC

S: 20...250V AC/DC

**10. Output logic**

N: NPN

P: NP

B: AC/DC 2 wires

F: NPN+PNP

T: AC 2wires

K: Relay

**11. Output status**

O: NO

C: NC

R: NO+NC

B: NO/NC optional

L: IO-link

**12. Switch function**

Blank: Standard function

G: Frequency enhanced

T1: On-delay function

T2: Off-delay function

Y: Extended distance

**13. Connection**

Blank: 2m cable

xM: xM cable (x: number)

e.g. 3M: 3M cable

E1: M8 3-pins connector

E2: M12 4-pins connector

E3: M8 4-pins connector

E5: M12 5-pins connector

Fx: Connector+cable

D: Terminal

**14. Special requirements**

4 digits or letters

Cylindrical

Square

Extended  
distanceFrequency  
enhancedCorrosion  
resistantPipe liquid  
levelHigh  
temperature  
resistant  
material level

Series	Model Sensing distance	Installation	CR12/S/X	CR18/S/X	CR30/S	CR30XS	CQ20/S	CQ32/S	CQ32XS	CQ34S
Standard cylindrical series	F		2mm	5mm	10mm	10mm	10mm	15mm	15mm	15mm
	NF		4mm	8mm	15mm		15mm	20mm		20mm

Series	Model Sensing distance	Installation	CE05S/XS	CE07S	CE34S	CE35S	CE39S
Standard flat series	F			5mm		10mm	
	NF		5/6/8mm	8mm	10mm	15mm	12mm

Series	Model Sensing distance	Installation	CR12/S/X	CR18/S/X	CR30/S	CE05S/XS	CE16S	CE17S	CE34S
Extended sensing distance series	F		4mm	8mm	15mm				
	NF		8mm	12mm	25mm				
Frequency enhanced series	F		4mm	8mm					
	NF					5mm	6mm	8mm	8mm
Corrosion resistant series	F			5/8mm					
	NF			8/12mm					

Series	Model Sensing distance	Installation	CE10S	CE15S	CE53S
Pipe liquid level series	NF		13mm	26mm	
High temperature resistant material level series	NF				8mm

- Cylindrical
- Square
- Extended distance
- Frequency enhanced
- Corrosion resistant
- Pipe liquid level
- High temperature resistant material level





## Capacitive Sensors

# Standard Cylindrical Series



For specifications, certification, usage and model list, please scan the product QR code.



### Cylindrical

Square

Extended distance

Frequency enhanced

Corrosion resistant

Pipe liquid level

High temperature resistant material level

## Product features

### Rich variety of products

Metal shell and plastic shell, cylindrical diameter from M12 to  $\phi 34$ .

### High protection degree

IP67 protection degree, with excellent water and oil resistance.

### Wider range of applications

Detection of metal, plastic, glass, liquid etc.

### Potentiometer sensitivity adjustment function

Potentiometer to adjust settings for different applications.

## Application

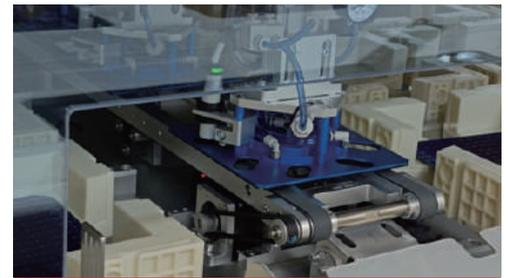

Vacuum chuck wafer presence detection

Naming rules



Official website

## DC series

Appearance	Model	Dimensions (mm)	Installation	Detection distance	Frequency	Supply voltage	Housing material	Output
	CR12	M12*1*52 M12*1*65	F	2mm	50Hz	10...30V DC	Nickel copper alloy	NPN/PNP NO/NC
		M12*1*55 M12*1*69	NF	4mm	50Hz			
	CR12S	M12*1*52 M12*1*65	F	2mm	50Hz		PBT	
		M12*1*55 M12*1*69	NF	4mm	50Hz			
	CR18	M18*1*70 M18*1*83.5	F	5mm	50Hz		Nickel copper alloy	
		M18*1*83.5 M18*1*91.5	NF	8mm	50Hz			
	CR18S	M18*1*70 M18*1*83.5	F	5mm	50Hz		PBT	
		M18*1*83.5 M18*1*91.5	NF	8mm	50Hz			
	CR30	M30*1.5*62 M30*1.5*79	F	10mm	50Hz		Nickel copper alloy	
		M30*1.5*79 M30*1.5*91	NF	15mm	50Hz			
	CR30S	M30*1.5*62 M30*1.5*79	F	10mm	50Hz		PBT	
		M30*1.5*79 M30*1.5*91	NF	15mm	50Hz			
	CQ20	Φ20*80	F	10mm	50Hz		Nickel copper alloy	
	CQ20S	Φ20*80	F	10mm	50Hz		PBT	
			NF	15mm	50Hz			
	CQ32	Φ32*80	F	15mm	50Hz		Nickel copper alloy	
	CQ32S	Φ32*80	F	15mm	50Hz	PBT		
			NF	20mm	50Hz			
	CQ34S	Φ34*80	F	15mm	50Hz	PBT		
			NF	20mm	50Hz			

Note: The repeatability of the above products is  $\leq 3\%$ .

Capacitive

Cylindrical

Square

Extended distance

Frequency enhanced

Corrosion resistant

Pipe liquid level

High temperature resistant material level

Naming rules



Official website

## AC series

Appearance	Model	Dimensions (mm)	Installation	Detection distance	Frequency	Supply voltage	Housing material	Output
	CR18	M18*1*70 M18*1*83.5	F	5mm	15Hz	20...250V AC	Nickel copper alloy	NO/NC
		M18*1*83.5 M18*1*91.5	NF	8mm	15Hz			
	CR18S	M18*1*70 M18*1*83.5	F	5mm	15Hz	20...250V AC	PBT	
		M18*1*83.5 M18*1*91.5	NF	8mm	15Hz			
	CR30	M30*1.5*32 M30*1.5*79	F	10mm	15Hz	20...250V AC	Nickel copper alloy	
		M30*1.5*79 M30*1.5*91	NF	15mm	15Hz			
	CR30S	M30*1.5*62 M30*1.5*79	F	10mm	15Hz AC: 15Hz DC: 40Hz	20...250V AC 20...250V AC/DC	PBT	
		M30*1.5*79 M30*1.5*91	NF	15mm				
	CR30XS	M30*1.5*64 M30*1.5*81	Quasi-flush	10mm	Delay function	20...250V AC/DC	PBT	
	CQ20	Φ20*80	F	10mm	15Hz	20...250V AC	Nickel copper alloy	
	CQ20S	Φ20*80	NF	10mm	15Hz	20...250V AC	PBT	
			NF	15mm	15Hz			
	CQ32	Φ32*80	F	15mm	15Hz	20...250V AC	Nickel copper alloy	
	CQ32S	Φ32*80	F	15mm	15Hz	20...250V AC	PBT	
			NF	20mm	15Hz AC: 15Hz DC: 40Hz	20...250V AC 20...250V AC/DC		
	CQ32XS	Φ34*80	Quasi-flush	15mm	Delay function	20...250V AC/DC	PBT	
	CQ34S	Φ34*80	F	15mm	15Hz	20...250V AC	PBT	
			NF	20mm	15Hz AC: 15Hz DC: 40Hz	20...250V AC 20...250V AC/DC		

Note: The repeatability of the above products is  $\leq 3\%$ .



Capacitive

Cylindrical

Square

Extended distance

Frequency enhanced

Corrosion resistant

Pipe liquid level

High temperature resistant material level

Naming rules



Official website

## Capacitive Sensors

## Standard Flat Series



For specifications, certification, usage and model list, please scan the product QR code.



Cylindrical

Square

Extended distance

Frequency enhanced

Corrosion resistant

Pipe liquid level

High temperature resistant material level

## Product features

### Rich variety of products, wide options

Metal shell and plastic shell.

### Potentiometer adjustment

Sensitivity can be adjusted.

### Excellent detection performance

Meet a variety of position and level detection.

## Application

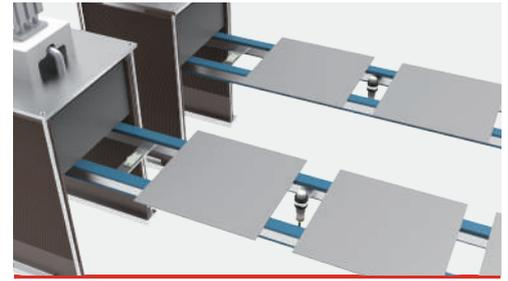

Cache silicon wafer inspection

## Model specification

Appearance	Model	Dimensions (mm)	Installation	Detection distance	Frequency	Repeatability	Housing material	Output
	CE05XS	30*7*50	NF	5mm	30Hz	≤3%	PBT	NPN/PNP NO/NC
	CE05S	50*20*5	NF	5mm	30Hz	≤3%		
				6mm				
				8mm	30Hz	≤5%		
	CE07S	30*7*50	F	5mm	60Hz	≤3%		
			NF	8mm				
	CE34S	50*7*20	NF	10mm	60Hz	≤3%		
	CE35S	35*15*58	F	10mm	60Hz	≤3%		
			NF	15mm				
	CE39S	39*59*15	NF	12mm	50Hz	≤5%		

Note: The supply voltage of the above products is 10...30V DC.

Naming rules



Official website

# Extended Sensing Distance Series

Capacitive



For specifications, certification, usage and model list, please scan the product QR code.



## Product features

- Extended sensing distance**  
Allowing installation at a greater distance for object detection.
- Clearly visible working state**  
Power supply, signal dual indicator design.
- Sensitivity adjustment, high accuracy**  
Multi-turn potentiometer, higher adjustment accuracy.

## Application



Food packaging and logistics inspection

Cylindrical

Square

Extended distance

Frequency enhanced

Corrosion resistant

Pipe liquid level

High temperature resistant material level

## Model specification

Appearance	Model	Dimensions (mm)	Installation	Detection distance	Frequency	Repeatability	Housing material	Output
	CR12X-Y	M12*1*63, M12*1*75	F	4mm	20Hz	≤5%	Nickel copper alloy	NPN/PNP NO/NC
		M12*1*68, M12*1*80	NF	8mm				
	CR12XS-Y	M12*1*62, M12*1*74	F	4mm	18Hz	≤5%	PBT	
		M12*1*67, M12*1*79	NF	8mm				
	CR18X-Y	M18*1*70, M18*1*85	F	8mm	20Hz	≤5%	Nickel copper alloy	
		M18*1*85, M18*1*95	NF	12mm				
	CR18XS-Y	M18*1*70, M18*1*85	F	8mm	18Hz	≤5%	PBT	
		M18*1*85, M18*1*95	NF	12mm				
	CR30X-Y	M30*1.5*64, M30*1.5*81	F	15mm	25Hz	≤5%	Nickel copper alloy	
		M30*1.5*81, M30*1.5*96	NF	25mm				
	CR30XS-Y	M30*1.5*64, M30*1.5*81	F	15mm	20Hz	≤5%	PBT	
		M30*1.5*81, M30*1.5*96	NF	25mm				

Note: The supply voltage of the above products is 10...30V DC.

Naming rules



Official website

## Capacitive Sensors

## Frequency Enhanced Series



For specifications, certification, usage and model list, please scan the product QR code.



Cylindrical

Square

Extended distance

Frequency enhanced

Corrosion resistant

Pipe liquid level

High temperature resistant material level

## Product features

## Frequency enhanced series

Fast response, frequency up to 100Hz.

## IP67 Protection degree

Excellent waterproof.

## Knob adjustment

Distance can be adjusted by knob.

## Application

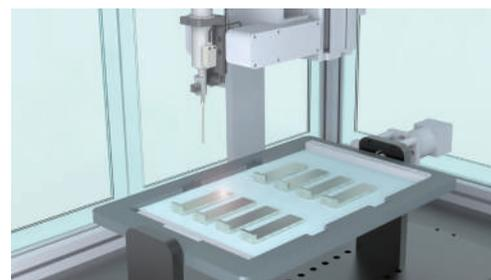

Glue level detection

## Model specification

Appearance	Model	Dimensions (mm)	Installation	Detection distance	Repeatability	Housing material	Output
	CR12X-G	M12*1*63	F	4mm	≤5%	Nickel copper alloy	NPN/PNP NO/NC
	CR18X-G	M18*1*70	F	8mm	≤6%		
	CE05S-G	20*55*5.5	NF	5mm	≤5%	PBT	NPN/PNP NO
	CE05XS-G	20*55*5.5	NF	5mm	≤5%		
	CE16S-G	16*37.1*12	NF	6mm	≤6%	ABS	NPN/PNP NO/NC
	CE17S-G	17*32*10.5	NF	8mm	≤5%	ABS	NPN/PNP NO/NC
	CE34S-G	50*7*20	NF	8mm	≤3%	ABS	NPN/PNP NO

Note: The supply voltage of the above products is 10...30V DC, frequency is 100Hz.

Naming rules



Official website

# Corrosion Resistant Series

Capacitive



For specifications, certification, usage and model list, please scan the product QR code.



## Product features

## Application

### Excellent anti-corrosion performance

PTFE housing, chemical and oil resistant.

### Potentiometer adjustment

Sensitivity can be adjusted.

### Excellent level detection performance

Meet the needs of various contact liquid level detection, easily solve the problems caused by various wall hanging.

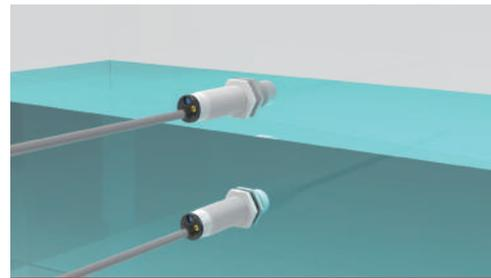

Liquid level detection

Cylindrical

Square

Extended distance

Frequency enhanced

**Corrosion resistant**

Pipe liquid level

High temperature resistant material level

## Model specification

Model	Dimensions (mm)	Installation	Detection distance	Frequency	Repeatability	Housing material	Output
CR18XT	M18*80	F	5mm	20Hz	≤5%	PTEE	NPN/PNP NO+NC
		NF	8mm				
			12mm				
		Quasi-flush	8mm				

Note: The supply voltage of the above products is 10...30V DC.

Naming rules



Official website



## Capacitive Sensors

## Pipe Liquid Level Series



For specifications, certification, usage and model list, please scan the product QR code.



## Product features

### Flexible and simple installation

Curved appearance design, can be detected through non-metal pipe wall level.

### Potentiometer adjustment

Adjustable sensitivity via potentiometer, easy setting.

### IP67 protection degree

Special structure to achieve good waterproof and dustproof performance.

## Application



Metal part inspection on the assembly line

## Model specification

Appearance	Model	Dimensions (mm)	Installation	Detection distance	Repeatability	Housing material	Output
	CE10S	43*24*20	NF	13mm	≤3%	PBT	NPN/PNP NO/NC
	CE15S	34*33*20	NF	26mm			

Note: The supply voltage of the above products is 10...30V DC, frequency is 60Hz.

Cylindrical

Square

Extended distance

Frequency enhanced

Corrosion resistant

Pipe liquid level

High temperature resistant material level

Naming rules



Official website

# High Temperature Resistant Material Level Series



For specifications, certification, usage and model list, please scan the product QR code.



## Product features

### Strong sensing head

Stainless steel housing ensures reliable operation and durability.

### Extremely high environmental tolerance

Separate structure design, with excellent chemical corrosion and oil resistance.

### Fast installation

Simple structure design, easy to install.

### Operate through a separate amplifier

The separate amplifier has the function of clear working state indication and sensitivity adjustment.

Cylindrical

Square

Extended distance

Frequency enhanced

Corrosion resistant

Pipe liquid level

High temperature resistant material level

## Model specification

Model	Dimensions (mm)	Installation	Detection distance	Frequency	Repeatability	Ambient temp	Housing material	NPN/PNP NO/NC
CE53S	Amplifier: 95.5*55*22 Head: Φ16*150 Φ16*100	NF	8mm	0.3Hz	≤5%	Amplifier: 250°C Head: 0...60°C	Amplifier:PA6 Head: Teflon+SS	Output

Note: The supply voltage of the above products is 10...36V DC

Naming rules



Official website

03

# Photoelectric Sensors

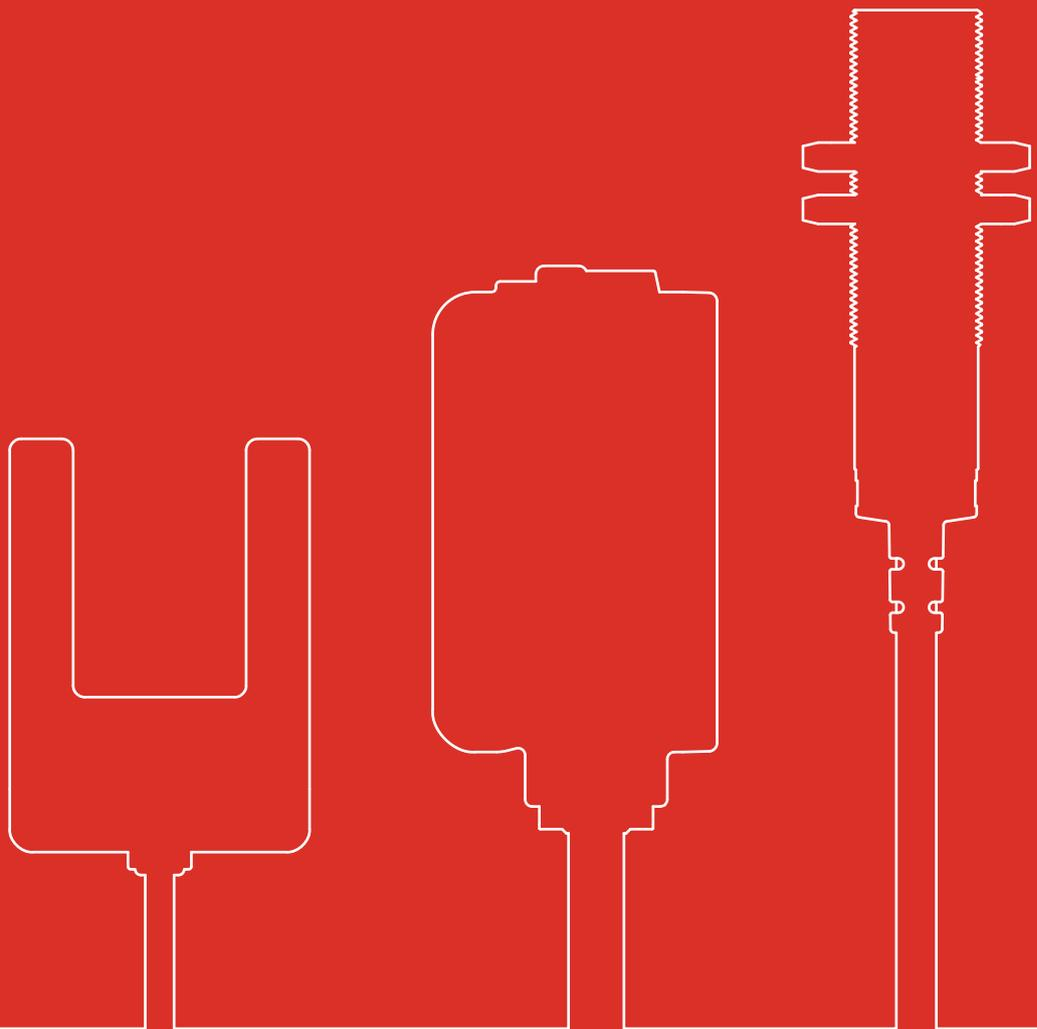

# Product Family

## Ultra-thinseries

Suitable for small installationconditions.



**C01-005** PSV/PSW

## Micro square series

Compact to installwith a bright 360° LED indicator to easily identify special working conditions.



**C02-001** PST/PSJ

## Little square series

Universal small square, comprehensive product line coverage.



**C03-001** PSE

## Large square series

Various output methods to meet various needs.



**C04-001** PTL/PTE/PTB

## Round and square series

Threaded combination designmakes installation and use more convenient.



**C05-001** PSR

## Eries

M12, M18, M30, various sizes available.



**C06-001** PSS/PSM/PR12  
RP18/PR30

## Slot series

Comprehensive specifications,various shapes and connection methods are available, and the detection accuracy is high.



**A13-01** PU05/PU07/PU13  
PU15/PU30

## Optical fiber series

Amplifier is separated to adapt to different harsh environments; Variety of appearances are available to measure most objects



**C08-001** PFR/PFT  
PGR/PGT

## Color sensor

Covers a wide rangeand can distinguish more than 3000 colors; Multi-channel output, simple calibration, easy operation.



**C09-001** CPES

## Color mark sensor

Comprehensive coverage of light source types, optional RGB/WB types.



**C10-001** SPM/SPN

## Label sensor

Ultrasonic /photoelectric principle, can stably detect all kinds of labels.



**C11-001** LAP/LAU

# Universal Photoelectric Sensor

P R 12 □ □ B C15 D N O □ - □ □ □  
 ① ② ③ ④ ⑤ ⑥ ⑦ ⑧ ⑨ ⑩ ⑪ ⑫ ⑬ ⑭

## 1. Classification code

P: Photoelectric sensor

## 2. Appearance

R: Threaded cylindrical  
 Q: Smooth cylindrical shell  
 Two letters: Square shell  
 TE TF TB SE SS SM  
 SR SV ST

## 3. Size code

Number: Shell size  
 For example: 18: Outer diameter 18mm

## 4. Shell material

Blank: metal copper shell  
 S: Plastic

## 5. Dimensions

Blank: Standard  
 S: Short  
 L: Long

## 6. Installation method

B: Diffuse reflection  
 D: Retro-reflection  
 P: Polarized reflection  
 S: Limited reflection  
 T: Through-beam  
 Y: Background suppression  
 G: Transparent object detection

## 7. Detection distance

C10: 10cm  
 C40: 40cm  
 M5: 5m  
 M10: 10m  
 ...

## 8. Working voltage

A: 20...250V AC  
 A1: 110V AC  
 A2: 220V AC  
 B: 90...250V AC  
 D: 10...30V DC  
 J: 5V DC  
 Q: 12...24V AC/DC  
 S: 12...240V DC/24...240V AC  
 T: 12...24V DC  
 V: 18...30V DC

## 9. Output logic

T: AC 2 wires  
 P: PNP  
 N: NPN  
 E: NPN/PNP  
 F: NPN+PNP  
 K: Relay  
 G: Push-Pull

## 10. Output status

O: Normally open  
 C: Normally closed  
 R: Normally open + Normally closed  
 A: Normally open/normally closed reversible  
 B: Normally open/normally closed optional  
 Divided into optional cables and optional potentiometers  
 Note: relay output can be unselected  
 L: IO-Link

## 11. Light source type

Blank: Infrared light  
 R/S: Red point light source  
 B: Blue point light source  
 L: Red laser  
 V: Red Vcsel light source  
 X: Red line light source  
 W: White point light source

## 12. Cable length

Blank: 2m  
 3M: 3m  
 ...

## 13. Connection

Blank: 2M cable type  
 E1: M8 3-pins connector  
 E2: M12 4-pins connector  
 E3: M8 4-pins connector  
 E4: M12 4-pins connector  
 E5: M12 5-pins connector  
 D: Internal connector  
 F3: M8 3-pins connector + 0.2m cable

## 14. Special requirements

4 Digits or letters

Ultra-thin

Micro square

Little square

Large square

Round and square

Cylindrical

U shaped

Optical fiber

Color sensor

Color mark sensor

Label sensor

Naming rule



Detection distance Light source Name	Through-beam			Diffuse		Retro-reflection	Background suppression			Polarized reflection			Limited reflection	Transparent object detection	TOF
	5m/10m Red light	20m Infrared	30m Red laser	10cm/100cm Infrared	30cm Red light		15cm Red Vcsel	5cm/25cm/35cm Red light	15cm/35cm Red laser	1m Red Vcsel	3m Red light	5m/10m Red laser	30cm Red light	50cm/2m Blue	20cm/60cm/100cm/3m Infrared
PSE Series	50cm/2m	2m				25cm	16mm/30mm/10cm						25mm		
	Red Vcsel	Red light				Red light	Red light						Red light		
PST Series	1.5m/3m														
	Infrared														
PSJ Series	15cm/50cm/1m			10cm			15mm/30mm						25mm		
	Red light (side light)			Red light			Red light						Red light		
PSV Series	20m			30cm			10cm			3m					
	Infrared			Red light			Red light			Red light					
PSR Series	20m		10cm/40cm/100cm	40cm			10cm			3m	40cm	2m			
	Infrared		Infrared	Red light			Red light			Red light	Red light	Red light			
PSM Series	20m		10cm/40cm/100cm	40cm			10cm			3m	40cm	2m			
	Infrared		Infrared	Red light			Red light			Red light	Red light	Red light			
PSS Series	5m/10m			15cm	3m										
	Infrared			Infrared	Infrared										
PR12 Series	10m/20m			10cm/40cm	5m										
	Infrared			Infrared	Infrared										
PR18 Series	20m/40m/100m/150m			50cm/100cm			10cm								
	Infrared			Infrared			Red light								
PR30 Series	60m			30cm/200cm					5m						
	Infrared			Infrared					Red light						
PTE Series				80cm/200cm					12m						
				Infrared					Red light						
PTL Series															

- Ultra-thin
- Micro square
- Little square
- Large square
- Round and square
- Cylindrical
- U shaped
- Optical fiber
- Color sensor
- Color mark sensor
- Label sensor

Naming rule



Official Website

## Photoelectric Sensors

## Ultra-Thin Series



For specifications, certification, usage and model list, please scan the product QR code.



## Ultra-thin

Micro square

Little square

Large square

Round and square

Cylindrical

U shaped

Optical fiber

Color sensor

Color mark sensor

Label sensor

## Product features

### Ultra-thin design and compact structure

With a thickness of only 4.2mm, it can be easily installed in small spaces, such as under conveyor belts or other compact environment.

### High precision and stable detection

Reliable detection of opaque objects larger than  $\phi 2\text{mm}$ , with a response time of less than 1ms.

### Easy to install and maintain

High-brightness indicator lights and multiple protection circuits make the installation and maintenance of the sensor more convenient and efficient.

## Application

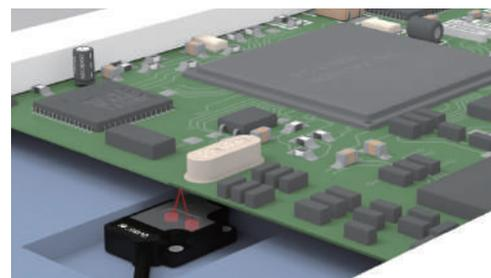

Small electronic components in place detection

## Model specification

Model	Detection principle	Detection distance	Spot size (red point lightsource)	Blind zone	Adjustment method	Power supply	Output method	
PSV-T-S (Side light)	Through-beam	50cm	7*7cm@50cm	/	Not adjustable	10-30V DC (Ripple P-P: $\leq 10\%$ )	NPN NO, NPN NC PNP NO, PNP NC	
		1m	7*7cm@50cm	/	Not adjustable			
PSW-T (front light)		15cm	5*5cm@15cm	/	Not adjustable			
		50cm	16*16cm@50cm	/	Not adjustable			
PSV-BC	Diffuse	1...10cm	15mm@10cm	<5mm	Not adjustable			
PSV-YR	Background suppression	2...16mm	2mm@30cm	<2mm	Not adjustable			
		4...33mm	2mm@30cm	<4mm	Not adjustable			
PSV-SR	Limited reflection	2...28mm	8mm@25mm	<2mm	Not adjustable			



Ultra-thin

Micro square

Little square

Large square

Round and square

Cylindrical

U shaped

Optical fiber

Color sensor

Color mark sensor

Label sensor

Naming rule





## Photoelectric Sensors

## Micro Square Series



For specifications, certification, usage and model list, please scan the product QR code.



Ultra-thin

Micro square

Little square

Large square

Round and square

Cylindrical

U shaped

Optical fiber

Color sensor

Color mark sensor

Label sensor

## Product features

## Miniaturization and integration

Suitable for installation and integration in limited space, the installation process is simpler and faster, reducing installation time and cost.

## Wide range of applications

Micro square photoelectric sensors are widely used in many fields such as medical treatment, environmental protection, agriculture, industrial automation, communication, etc.

## Strong environmental resistance

PST micro sensor is specially designed and tested, IP65 protection level, integrated chip design, withstand harsh industrial automation applications.

## Application



Detection through slits or holes

## Model specification

Model	Detection principle	Detection distance	Light source type	Spot size	Blind area	Adjustment method	Output method
PST-T	Through beam	2m	Point light	80mm@2m	/	Not adjustable	NPN NO, NPN NC PNP NO, PNP NC
			Vcsel	15mm@2m			
		50cm	Vcsel	4mm@50cm			
PST-D	Retro-reflection	5...25cm	Point light	10mm@25cm	/		
PST-S	Retro-reflection	2...25mm	Point light	8mm@30cm	<2mm		

Note: PST series voltage is: 10-30VDC (Ripple P-P: ≤ 10%)



Model	Detection principle	Detection distance	Light source type	Spot size	Blind area	Adjustment method	Output method
PST-Y	Background suppression	16mm	Point light	<3mm@16mm	<1mm	Not adjustable	NPN NO, NPN NC PNP NO, PNP NC
		4...18mm	Point light	5mm@15mm	<4mm	Knob adjustment	
		4...36mm	Point light	5mm@30mm			
		1.5...10cm	Point light	8mm@100mm	<1.5cm		
		2...10cm	Vcsel	3mm@100mm			

Ultra-thin

**Micro square**

Little square

Large square

Round and square

Cylindrical

U shaped

Optical fiber

Color sensor

Color mark sensor

Label sensor

Naming rule



Official Website

## Photoelectric Sensors

## Little Square Series



For specifications, certification, usage and model list, please scan the product QR code.



Ultra-thin

Micro square

Little square

Large square

Round and square

Cylindrical

U shaped

Optical fiber

Color sensor

Color mark sensor

Label sensor

## Product features

## Comprehensive product line coverage

Small shape, with reflection, diffuse reflection, background suppression, polarization reflection, wide Angle of view and other specifications, the detection distance covers 10cm-20 meters, and the connection method has cable, connector optional, easy to select a variety of application scenarios.

## Quick response

Lanbao PSE small square photoelectric sensor can adjust the sensitivity and detection distance through knobs or buttons, and the setting is accurate, convenient and fast.

## Accurate positioning without proliferation

Laser series products, with small spot size, can reliably detect small objects and accurately position them.

## Application

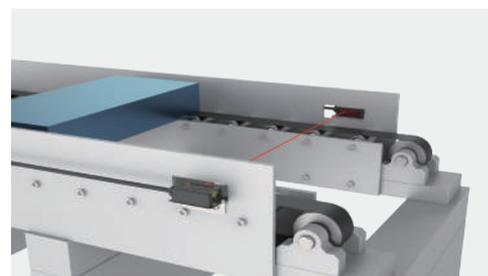

Detection through slits or holes

## Model specification

Model	Detection principle	Detection distance	Light source type	Spot size	Blind area	Adjustment method	Output method
PSE-Y	Background suppression	0.2...5cm	Red point light source	2mm@5cm	≤2mm	Knob adjustment	NPN NO+NC PNP NO+NC
		0.2...15cm	Red Vcsel	2mm@15cm	≤2mm		
		0.5...15cm/35cm	Red laser	3mm@15cm	≤5mm		
		0.2...25cm/35cm	Red point light source	7mm@35cm	≤2mm		
PSE-T	Through-beam	5m	Red point light source	1.5cm@1m	/	Knob adjustment	NPN NO+NC PNP NO+NC
		10m	Red point light source	/	/		
		20m	Infrared light	/	/		
		30m	Red laser	36mm@30m	/		



Official Website

Naming rule

Model	Detection principle	Detection distance	Light source type	Spot size	Blind area	Adjustment method	Output method
PSE-P ②	Polarized reflection	1m	Red vcsel	2mm@50cm	/	Not adjustment	NPN NO/NC PNP NO/NC
		3m	Red point light source	35mm@2m	/	Button adjustment	
		① 2m/5m/8m/ 10m/12m	Red laser	10mm@5m	/	Knob adjustment	NPN NO+NC PNP NO+NC
PSE-B	Diffuse	10cm	Infrared light	7cm@10cm	/	Button adjustment	NPN NO/NC PNP NO/NC
		30cm	Red point light source	8mm@30cm	/	Knob adjustment	
		100cm	Infrared light	/	/	Button adjustment	
PSE-SC	Limited reflection	0.3...10cm	Red line light source	7*70mm@100mm	≤5mm	Knob adjustment	
PSE-G	Transparent object detection	50cm/2m	Blue point light source	≤14mm@50cm	/	Button adjustment	
		50cm/2m	Blue point light source	≤60mm@2m	/	Button adjustment	
PSE-C	TOF	0.5...20cm	Infrared vcsel	φ50mm@60cm	≤5mm	Button adjustment	
		0.5...60cm	Infrared vcsel	φ130mm@60cm	≤5mm	Button adjustment	
		0.5...100cm	Infrared vcsel	φ120mm@100cm	≤5mm	Button adjustment	
		0.005...3m	Infrared vcsel	90×120mm@300cm	≤5mm	Button adjustment	
		0.02...3m	Infrared vcsel	90×120mm@300cm	≤2mm	Button adjustment	RS-485 (support ModBus protocol)

①: 5m and 10m specifications do not come with a reflector as standard, 2m specifications come with a TD-24 reflector as standard, 8m specifications come with a TD-09 reflector as standard, and 12m specifications come with a TD-09A reflector as standard.

②: For PSE-P series, the installation distance between the reflector and the sensor should be greater than 15cm.

Ultra-thin  
Micro square  
**Little square**  
Large square  
Round and square  
Cylindrical  
U shaped  
Optical fiber  
Color sensor  
Color mark sensor  
Label sensor

Naming rule



Official Website

## Photoelectric Sensors

## Large Square Series



For specifications, certification, usage and model list, please scan the product QR code.



## Product features

## Wide range of scene applications

Diffuse reflection, polarized reflection and other specifications are available, the detection distance covers a full range, and cable, connector and terminal types are available, which is convenient for quick selection in various application scenarios.

## Strong applicability

Contains digital output and relay output, AC and DC power supply optional, more applicable.

## Application

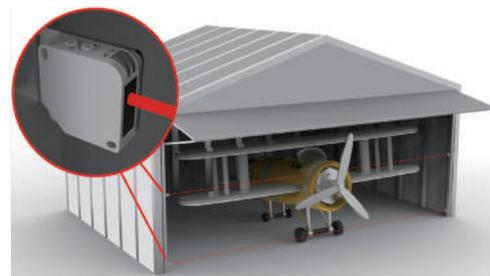

Aircraft or vehicle outbound inspection

## Model specification

Model	Detection principle	Detection distance	Light source type	Adjustment method	Output method	Supply voltage
PTE-T	Through-beam	60m	Infrared light	Potentiometer adjustment	NPN+PNP NO/NC	10...30 V DC
PTE-T		60m	Infrared light	Potentiometer adjustment	Relay output	24...240 V AC/DC
PTL-B	Diffuse	80cm	Infrared light	Potentiometer adjustment	Relay output	24...240 V AC/12...240V DC
		200cm	Infrared light	Potentiometer adjustment	NPN NO+NC PNP NO+NC	10...30 VDC
PTL-P	Polarized reflection	12m	Red point light source	Not adjustable	Relay output	24...240 V AC/12...240V DC
					NPN NO+NC PNP NO+NC	10...30 V DC
PTB-Y	Background suppression	2m	Infrared light	Potentiometer adjustment	NPN+PNP NO/NC	10...30 V DC



Ultra-thin

Micro square

Little square

Large square

Round and square

Cylindrical

U shaped

Optical fiber

Color sensor

Color mark sensor

Label sensor

Naming rule

Photoelectric

Ultra-thin

Micro square

Little square

**Large square**

Round and square

Cylindrical

U shaped

Optical fiber

Color sensor

Color mark sensor

Label sensor

Naming rule



## Photoelectric Sensors

## Round and Square Series



For specifications, certification, usage and model list, please scan the product QR code.



- Ultra-thin
- Micro square
- Little square
- Large square
- Round and square**
- Cylindrical
- U shaped
- Optical fiber
- Color sensor
- Color mark sensor
- Label sensor

## Product features

### Wide range of scene applications

Lanbao PSR series photoelectric sensors include multiple detection principles such as through-beam, diffuse reflection, background suppression, polarized reflection, etc. The detection distance ranges from 10cm to 20m. Cable and connector types are optional, which is convenient for quick selection in various application scenarios.

### Clear visibility

Lanbao PSR series photoelectric sensors have a bright 360° LED indicator light, making it easy to identify working conditions.

### Easy installation

Lanbao PSR series photoelectric sensors have two installation methods: flush installation and M3 knob installation. Customers can choose freely.

## Application

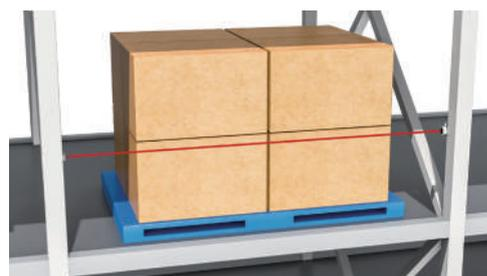

Cargo deviation detection

## Model specification

Model	Detection principle	Detection distance	Light source type	Spot size	Blind area	Adjustment mode	Output mode	Supply voltage
PSR-T	Through-beam	0...20m	Infrared light	/	/	Potentiometer adjustment	NPN NO/NC PNP NO/NC	10-30V DC (RippleP-P: ≤10%)
PSR-B	Diffuse	0.5...30cm	Red point light source	18*18mm@30cm	5mm	Potentiometer adjustment	NPN NO/NC PNP NO/NC	10-30V DC Ripple: ≤100mA
PSR-Y	Background suppression	10cm	Red point light source	8*8mm@100mm	10mm	Potentiometer adjustment	NPN NO/NC PNP NO/NC	10-30V DC Ripple: ≤25mA
PSR-P	Polarized reflection	0...3m	Red point light source	180*180mm@3m	/	Potentiometer adjustment	NPN NO/NC PNP NO/NC	10-30V DC Ripple: ≤100mA



Photoelectric

Ultra-thin

Micro square

Little square

Large square

**Round and square**

Cylindrical

U shaped

Optical fiber

Color sensor

Color mark sensor

Label sensor

Naming rule





## Photoelectric Sensors

## Cylindrical Series



For specifications, certification, usage and model list, please scan the product QR code.



- Ultra-thin
- Micro square
- Little square
- Large square
- Round and square
- Cylindrical**
- U shaped
- Optical fiber
- Color sensor
- Color mark sensor
- Label sensor

## Product features

## Wide range of applications

A variety of sizes are available, including M12, M18, and M30, with through-beam, diffuse reflection, and background suppression. Various specifications of polarization and reflection, rich product lines, can meet the needs of different scenarios.

## Sturdy and durable

High-quality materials, strong and durable, far superior to conventional products, and can cope with various harsh working conditions.

## Easy to install

The threaded shape design allows flush installation to meet various working conditions.

## Application



Security gate passes the test

## Model specification

Model	Detection principle	Detection distance	Blind area	Light source type	Spot size	Adjustment mode	Output mode	Supply voltage
PSM-T PSS-T	Through-beam	20m	/	Infrared light	/	Potentiometer adjustment	NPN NO/NC PNP NO/NC	10-30V DC (RippleP-P: ≤10%)
PSM-B PSS-B	Diffuse	10cm	7mm	Infrared light	10mm	Potentiometer adjustment	NPN NO/NC PNP NO/NC	
		40cm	/	Red light	15*15@40cm	Potentiometer adjustment	NPN NO/NC PNP NO/NC	
				Infrared light	/	Potentiometer adjustment	NPN NO/NC PNP NO/NC	
		100cm	3mm	Infrared light	/	Potentiometer adjustment	NPN NO/NC PNP NO/NC	
PSM-Y PSS-Y	Background suppression	10cm	4mm	Red light	8*8mm@10cm	Not adjustable	NPN NO/NC PNP NO/NC	
PSM-P PSS-P	Polarized reflection	3m	/	Red light	45*45mm@100cm	Potentiometer adjustment	NPN NO/NC PNP NO/NC	
PSM-G PSS-G	Transparent object detection	2m	/	Red light	45*45mm@100cm	Potentiometer adjustment	NPN NO/NC PNP NO/NC	10-30V DC Current consumption: ≤20mA

Note: All PSS series have plastic housings, and all PSM series have metal housings.



Model	Detection principle	Detection distance	Blind area	Light source type	Adjustment method	Output mode	Supply voltage
PR12-T PR12S-T	Through-beam	5m	/	Infrared light	Not adjustable	NPN NO+NC PNP NO+NC	10-30V DC (Ripple P-P: ≤10%)
		10m	/	Infrared light	Not adjustable	NPN NO+NC PNP NO+NC	10-30V DC (Ripple P-P: ≤10%)
PR12-B PR12S-B	Diffuse	15cm	2mm	Infrared light	Potentiometer adjustment	NPN NO+NC PNP NO+NC	10-30V DC (Ripple P-P: ≤10%)
PR18-T PR18S-T	Through-beam	10m	/	Infrared light	Not adjustable	NPN NO+NC PNP NO+NC AC two-wire NO AC two-wire NO	10-30V DC (Ripple P-P: ≤10%) 20...250V AC
		20m	/	Infrared light	Not adjustable	NPN NO+NC PNP NO+NC	10-30V DC (Ripple P-P: ≤10%)
PR18-B PR18S-B	Diffuse	10cm	2mm	Infrared light	Not adjustable	NPN NO+NC PNP NO+NC AC two-wire NO AC two-wire NO	10-30V DC (Ripple P-P: ≤10%) 20...250V AC
		40cm	2mm	Infrared light	Potentiometer adjustment	NPN NO+NC PNP NO+NC AC two-wire NO AC two-wire NO	10-30V DC (Ripple P-P: ≤10%) 20...250V AC
	3m	/	Infrared light	Not adjustable	NPN NO+NC PNP NO+NC	10-30V DC (Ripple P-P: ≤10%)	
					AC two-wire NO AC two-wire NO	20...250V AC	
PR18-D PR18S-D	Retro-reflection	3m	/	Infrared light	Not adjustable	NPN NO+NC PNP NO+NC AC two-wire NO AC two-wire NO	10-30V DC (Ripple P-P: ≤10%) 20...250V AC
PR18-Y	Background suppression	10cm	2mm	Infrared light	Potentiometer adjustment	NPN NO+NC PNP NO+NC	10-30V DC (Ripple P-P: ≤10%)
PR18G-T PR18GS-T	Through-beam	10m	/	Infrared light	Not adjustable	NPN NO+NC PNP NO+NC AC two-wire NO AC two-wire NO	10-30V DC (Ripple P-P: ≤10%) 20...250V AC
		20m	/	Infrared light	Not adjustable	NPN NO+NC PNP NO+NC	10-30V DC (Ripple P-P: ≤10%)
PR18G-B PR18GS-B	Diffuse	10m	/	Infrared light	Not adjustable	NPN NO+NC PNP NO+NC AC two-wire NO AC two-wire NO	10-30V DC (Ripple P-P: ≤10%) 20...250V AC
		20m	/	Infrared light	Not adjustable	NPN NO+NC PNP NO+NC	10-30V DC (Ripple P-P: ≤10%)
PR18G-D PR18GS-D	Retro-reflection	3m	/	Infrared light	Not adjustable	AC two-wire NO AC two-wire NO	20...250V AC
						NPN NO+NC PNP NO+NC	10-30V DC (Ripple P-P: ≤10%)

Ultra-thin  
Micro square  
Little square  
Large square  
Round and square

Cylindrical

U shaped  
Optical fiber  
Color sensor  
Color mark sensor  
Label sensor

Naming rule



Official Website

Model	Detection principle	Detection distance	Blind area	Light source type	Spot size	Adjustment method	Output mode	Supply voltage
PR30-T PR30S-T	Through-beam	20m	/	Infrared light	/	Not adjustable	NPN NO+NC PNP NO+NC	10-30V DC (Ripple P-P: ≤10%)
		40m	/	Infrared light	/		AC two-wire NC AC two-wire NC	20...250V AC
PR30-B PR30S-B	Diffuse	50cm	/	Infrared light	/	Potentiometer adjustment	NPN NO+NC PNP NO+NC	10-30V DC (Ripple P-P: ≤10%)
		100cm	2mm	Infrared light	/	Potentiometer adjustment	AC two-wire NC AC two-wire NC	20...250V AC
PR30-D PR30S-D	Through-beam	5m	/	Infrared light	/	Not adjustable	NPN NO+NC PNP NO+NC	10-30V DC (Ripple P-P: ≤10%)
							AC two-wire NC AC two-wire NC	20...250V AC
PR30L-T PR30LS-T	Through-beam	100m	/	Infrared light	/	Not adjustable	NPN NO+NC PNP NO+NC	10-30V DC (Ripple P-P: ≤10%)
		150m	/	Infrared light	/		NPN NO+NC PNP NO+NC	10-30V DC (Ripple P-P: ≤10%)

Ultra-thin  
Micro square  
Little square  
Large square  
Round and square

## Cylindrical

U shaped  
Optical fiber  
Color sensor  
Color mark sensor  
Label sensor

Naming rule



Photoelectric

Ultra-thin

Micro square

Little square

Large square

Round and square

**Cylindrical**

U shaped

Optical fiber

Color sensor

Color mark sensor

Label sensor

Naming rule



# U Shaped Series

P   U   □ - T   G   □   □ - □   □ - □   □  
 ①   ②   ③   ④   ⑤   ⑥   ⑦   ⑧   ⑨   ⑩   ⑪

## 1. Product categories

P: Photoelectric sensor

## 2. Appearance

U: U shaped

## 3. Slot width

× ×: Different slot widths,  
e.g. 05: 5mm

## 4. Detection principle

T: Through beam

## 5. Working voltage

G: 5...24V DC  
D: 10...30V DC

## 6. Output logic

N: NPN  
P: PNP

## 7. Output status

O: NO  
C: NC  
R: NO+NC  
B: NO/NC optional

## 8. Shell shape

One letter indicates the  
product appearance

## 9. Connection cable

Blank: Conventional cable  
R: Flexible cable

## 10. Connection method

Blank: Cable connection  
F4: 0.2m cable + M8 connector

## 11. Special requirements

4 Digits or letters

Ultra-thin

Micro square

Little square

Large square

Round and  
square

Cylindrical

U shaped

Optical fiber

Color sensor

Color mark  
sensor

Label sensor

Naming rule



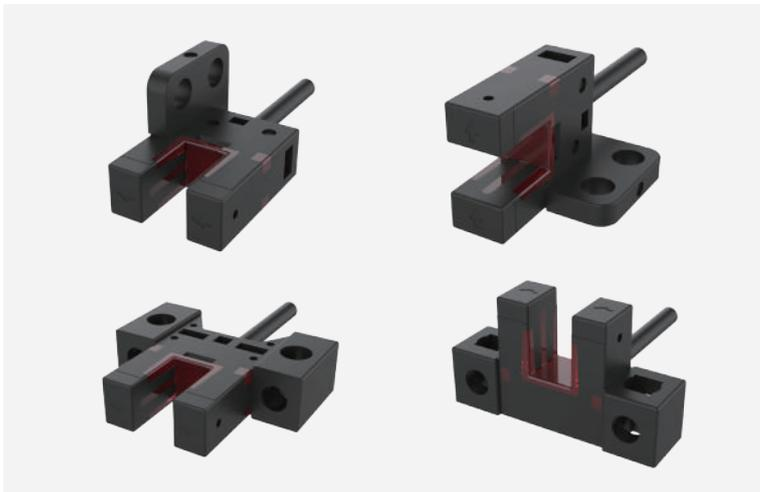

For specifications, certification, usage and model list, please scan the product QR code.



### Product features

- Comprehensive specifications, various shapes and connection methods are available, and the detection accuracy is high.
- The maximum response frequency can reach 3kHz.
- Automated production, high product consistency

### Application

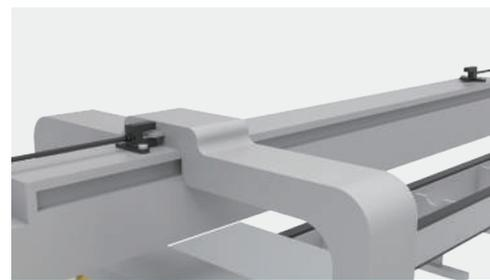

Tray transplating module in place detection

### Model specification

#### PU05M Series



Model	Detection principle	Slot width	Light source type	Standard test object	Response frequency	Working environment	Protection level	Connection
PU05M-□	U shaped through beam	5mm (not adjustable)	Infrared LED (855nm)	>1.2*0.8 (mm)	≥1kHz (MAX:3kHz)	-25°C...55°C	IP65 IP67	1m cable
PU05M-□-F4	U shaped through beam	5mm (not adjustable)	Infrared LED (855nm)	>1.2*0.8 (mm)	≥1kHz (MAX:3kHz)	-25°C...55°C	IP65 IP67	0.2mcable+M8 4 pin plug-in
PU05M-□ 1002	U shaped through beam	5mm (not adjustable)	Infrared LED (855nm)	>1.2*0.8 (mm)	≥1kHz (MAX:3kHz)	-25°C...55°C	IP65 IP67	5cm cable + connector

- Ultra-thin
- Micro square
- Little square
- Large square
- Round and square
- Cylindrical
- U shaped**
- Optical fiber
- Color sensor
- Color mark sensor
- Label sensor

Naming rule



## PU05S series



Model	Detection principle	Slot width	Light source type	Standard test object	Response frequency	Working environment	Protection level	Connection
PU05S-□	U shaped through beam	5mm (not adjustable)	Infrared LED (855nm)	>1.2*0.8 (mm)	≥1kHz (MAX:3kHz)	-25°C...55°C	IP65 IP67	1m cable

Note: The voltage of the above series is 5...24V DC

## Other slot models



Model	Detection distance	Slot width	Light source type	Detecting objects	Response time	Work environment	Protection level	Connection
PU07	U shaped through beam	7mm (not adjustable)	Infrared LED (modulated)	Opaque objects larger than $\phi$ 1mm	<1ms	-15...55°C	IP64	2m PVC cable
PU13S		13mm (not adjustable)	Infrared light (940nm)	/	<1ms	-10...55°C	IP50	2m PVC cable
PU15		15mm (not adjustable)	Infrared LED (modulated)	Opaque objects larger than $\phi$ 1.5mm	<1ms	-15...55°C	IP64	2m PVC cable
PU30		30mm (adjustable)	Infrared LED (modulated)	Opaque objects larger than $\phi$ 2mm	<1ms	-15...55°C	IP60	2m PVC cable
PU30-3001		30mm (not adjustable)	Infrared LED (modulated)	Opaque objects larger than $\phi$ 2mm	<1ms	-15...55°C	IP67	2m PVC cable
PU30S		30mm (adjustable)	Infrared LED (modulated)	Opaque objects larger than $\phi$ 2mm	Action and reset in less than 6ms	-15...55°C	IP66	2m PVC cable
PU30S-3001		30mm (not adjustable)	Infrared LED (modulated)	Opaque objects larger than $\phi$ 2mm	Action and reset in less than 6ms	-15...55°C	IP66	2m PVC cable

- Ultra-thin
- Micro square
- Little square
- Large square
- Round and square
- Cylindrical
- U shaped**
- Optical fiber
- Color sensor
- Color mark sensor
- Label sensor
- Naming rule



Photoelectric

Ultra-thin

Micro square

Little square

Large square

Round and square

Cylindrical

**U shaped**

Optical fiber

Color sensor

Color mark sensor

Label sensor

Naming rule





# Optical Fiber Series

## Fiber amplifier naming convention

**FD**   **1**     -       **11**   **R** -   

①   ②   ③ ④   ⑤   ⑥   ⑦   ⑧   ⑨   ⑩

### 1. Classification code

FD: Fiber Amplifier

### 2. Appearance

One digit

### 3. Industry/application

Factory definition

### 4. Working voltage

N/A: 12...24V DC

J: 5V DC

### 5. Output logic

N: NPN

P: PNP

Q: NPN\*2

F: PNP\*2

G: Push-Pull

H: Dual-channel Push-Pull

### 6. Output status

B: Normally open/normally closed

O: Normally open

C: Normally closed

R: Normally open + Normally closed

I: With current output 4-20mA

### 7. Switch mode

10: Wireless extension unit

11: Basic unit

### 8. Light source

N/A: infrared

R: Red light

### 9. Connection method

N/A: 2M cable

E1: M8 3-pins connector

E2: M12 4-pins connector

E3: M8 4-pins connector

E4: M12 4-pins connector

E5: M12 5-pins connector

F3: M8 3-pins connector+

0.2m cable

### 10. Special requirements

4 Digits or letters

Ultra-thin

Micro square

Little square

Large square

Round and square

Cylindrical

U shaped

Optical fiber

Color sensor

Color mark sensor

Label sensor



Fiber optic head naming rules



1. Classification code

PFR: Diffuse reflective fiber  
 PFT: Through-beam fiber  
 PGR: Glass diffuse reflection fiber  
 PGT: Glass through-beam fiber

2. Fiber core size

N/A: 1.0mm/φ2.2  
 B: 0.25mm/φ1.3  
 C: 0.25mm x16/φ2.2  
 0.25mm x9/φ1.3  
 D: 0.5mm/φ1.25  
 J: 0.75mm/φ1.25  
 S: 0.5mm/φ1.0  
 S2: 0.5mm/2.2  
 X: 1.5mm/φ2.2

3. Appearance

N/A: Metal thread  
 Q: No thread

4. Fiber head size

1: Outer diameter 1mm  
 1.5: Outer diameter 1.5mm  
 2: Outer diameter 2mm  
 3: Outer diameter 3mm  
 4: Outer diameter 4mm

5. Cable length

05: Fiber length is 50cm  
 10: Fiber length is 100cm  
 20: Fiber length is 200cm  
 30: Fiber length is 300cm

6. Convex pipe

N/A: No convex tube  
 I: Convex tube 10mm  
 S: Convex tube 20mm  
 M: Convex tube 40mm  
 L: Convex tube 90mm

7. Special features

V: 90° Right angle  
 JC: Integrated bracket  
 N: Tension enhancement

8. Special requirements

4 Digits or letters

- Ultra-thin
- Micro square
- Little square
- Large square
- Round and square
- Cylindrical
- U shaped
- Optical fiber
- Color sensor
- Color mark sensor
- Label sensor

Fiber focusing lens naming rules



1. Classification code

PFL: Fiber Lens

2. Model

R: Diffuse reflection  
 T: Through-beam type

3. Adaptation size

3: M3  
 4: M4  
 6: M6

4. Light output method

S: Straight light  
 V: Side light

5. Heat resistance

A: Below 100°C  
 B: 100...200°C  
 C: 200...300°C  
 D: 300...400°C

6. Product serial number

01 02 03 04...



## Photoelectric Sensors

## Optical Fiber Series



For specifications, certification, usage and model list, please scan the product QR code.



Ultra-thin  
Micro square  
Little square  
Large square  
Round and square  
Cylindrical  
U shaped

## Optical fiber

Color sensor  
Color mark sensor  
Label sensor

## Product features

### Extremely high sensitivity and precision

Fiber optic sensors can capture tiny changes in physical quantities and convert them into measurable optical signals, thereby achieving high-precision measurements.

### Applicable to various working conditions

Including diffuse reflection, through-beam, area, right angle, high temperature resistant and various types, which can adapt to various harsh installation environments.

## Application

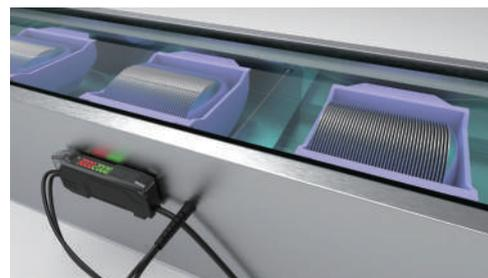

Check whether the water flow device is present

## Model specification

### Fiber amplifier series

Appearance	Light source	Response time	Output	Supply voltage	Ambient temperature	Shell material	Connection	Model
	Red visible light (660nm)	<1ms	NPN+PNP NO/NC	10...30V DC	0...55°C	PC+ABS	2m PVC cable	FD1-NPR
	Red visible light (660nm)	<200μs(FINE) <300μs(TURBO) <550μs(SUPER)	NPN NO/NC PNP NO/NC	12...24V DC	0...55°C	PC+ABS	2m PVC cable	FD2-NB11R FD2-PB11R
	Red visible light (650nm)	50μs (HIGH SPEED) 250μs (FINE) 1ms (SUPER) 16ms (MEGA)	NPN PNP	12...24V DC	-20...55°C	PC	2m PVC cable	FD3-NB11R FD3-PB11R
	Red visible light (650nm)	50μs (HIGH SPEED) 250μs (FINE) 8ms (SUPER) 8ms (MEGA)	NO/NC Optional	12...24V DC	-20...55°C	PC	2m PVC cable	FD3-NI11R FD3-PI11R



Fiber optic head series

Appearance	Specs	Type	Size	Cable length	Minimum bending radius	Detection distance (FD2/FD3)	Temperature resistance	Model
	Diffuse	Dual core	M6	1m	R25	190mm	- 40...70°C	PFR-610
				2m				PFR-620
			M4	1m	R15	90mm	- 40...70°C	PFRD-410
				2m				PFRD-420
			M3	1m	R15	70mm	- 40...70°C	PFRD-310
				2m	R10			PFRD-320
			2m	R10	70mm	- 40...70°C	PFRD-320-S	
		Coaxial	M6	1m	R25	170mm	- 40...70°C	PFRC-610
				2m				PFRC-620
			M4	1m	R15	70mm	- 40...70°C	PFRC-410
	M3	1m	R15	70mm	- 40...70°C	PFRC-310		
Right angle	M6	1m	R2	170mm	- 40...70°C	PFR-610-V		
		2m				PFR-620-V		
	M4	1m	R2	70mm	- 40...70°C	PFR-410-V		
		2m				PFR-420-V		
Increased pulling force	M6	2m	R25	190mm	- 40...70°C	PFR-620-N		
Window		2m	R5	25mm	- 40...70°C	PFR-S01		
	Through beam	Single core	M6	1m	R25	500mm	- 40...70°C	PFT-610
			M4	1m	R25	500mm	- 40...70°C	PFT-410
		3m		PFT-430				
		M3	1m	R25	400mm	- 40...70°C	PFT-310	
		Right angle	M6	2m	R2	500mm	- 40...70°C	PFT-620-V
				1m				PFT-610-V
			M4	2m	R2	500mm	- 40...70°C	PFT-420-V
				1m				PFT-410-V
		Array		2m	R2	1200mm	- 40...70°C	PFT-R01
	2m		2000mm	PFT-R02				

- Ultra-thin
- Micro square
- Little square
- Large square
- Round and square
- Cylindrical
- U shaped
- Optical fiber**
- Color sensor
- Color mark sensor
- Label sensor

Naming rule



Appearance	Specs	Type	Size	Cable length	Minimum bending radius	Detection distance	Temperature resistance	Model
	Glass diffuse reflection	Single core	M6	2m	R25	150mm	- 40...350°C	PGR-620
		Right angle	M4	1m	R25	120mm	- 40...350°C	PGR-410-V
				2m				PGR-420-V
			M6	2m	R25	150mm	- 40...350°C	PGR-620-V
	Glass through beam	Single core	M4	2m	R25	500mm	- 40...350°C	PGT-420

### Fiber optic head lens series

Appearance	Adaptation type	Adaptation size	Minimum spot	Ambient temperature resistance	Material	Model
	Diffuse reflective Fiber	M4	Φ1mm@20mm	-40...+70°C	Housing: aluminum; Lens:glass	PFL-R4SA01
	Optical fiber	M4		-60...+350°C	GlassHousing: aluminum; Lens: glass	PFL-T4SD01

Ultra-thin

Micro square

Little square

Large square

Round and square

Cylindrical

U shaped

Optical fiber

Color sensor

Color mark sensor

Label sensor

Naming rule



Photoelectric

Ultra-thin

Micro square

Little square

Large square

Round and square

Cylindrical

U shaped

**Optical fiber**

Color sensor

Color mark sensor

Label sensor

Naming rule



## Photoelectric Sensors

## Color Sensor



For specifications, certification, usage and model list, please scan the product QR code.



Ultra-thin  
Micro square  
Little square  
Large square  
Round and square  
Cylindrical  
U shaped  
Optical fiber

## Color sensor

Color mark sensor  
Label sensor

## Product features

- Wide coverage, suitable for 3000+ colors
- Can memorize up to 8 colors, dual channels can be switched, stable detection
- Simple calibration and easy operation

## Application

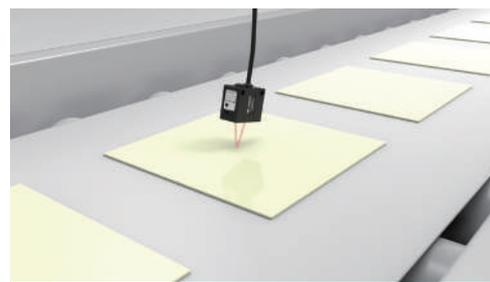

Flake presence detection

## Model specification

## Amplifier

Model	Response time	Control output	Output mode	Power supply	Timer	Ambient temperature	Protection circuit
CPES-TNB	200μs (HIGH SPEED) / 1ms (FINE) / 4ms (TURBO) / 8ms (SUPER)	NPN (PNP) open collector X4	NPN, PNP	24V DC	Timer OFF/OFF Delay/ON-delay/single trigger	-10...55°C	Short circuit protection, reverse polarity protection, zener protection
CPES-TPB							

## Detection head

Model	Detection range	Light source type	Minimum spot diameter	Ambient light resistance	Housing material	Protection degree	Connection
CPES-C09	11 ...2.0mm	Red/Green/Blue (665nm/520 nm/465 nm)	1mm@16mm	Incandescent lamp: maximum 1,000 lux; Sunlight: maximum 20,000 lux	Case: PC; Lens cover: polyarylate	IP40	2m PVC cable

Naming rule



Photoelectric

Ultra-thin

Micro square

Little square

Large square

Round and square

Cylindrical

U shaped

Optical fiber

**Color sensor**

Color mark sensor

Label sensor

Naming rule





Photoelectric Sensors

# Color Mark Sensor



For specifications, certification, usage and model list, please scan the product QR code.



- Ultra-thin
- Micro square
- Little square
- Large square
- Round and square
- Cylindrical
- U shaped
- Optical fiber
- Color sensor

- Color mark sensor**
- Label sensor

Naming rule

## Product features

- Comprehensive coverage of light source types, optional RGB/white light source
- Equipped with digital display function, debugging is more intuitive and convenient
- Wide detection range, 11-500mm with corresponding specifications

## Application

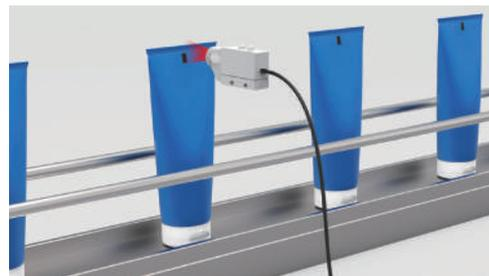

Hose color mark detection

## Model specification

### SPM Series

Product image	Model	Detection distance	Light source	Ambient temperature	Output method	Protection level	Connection
	SPM-TNR-RGB	18...28mm	Red (640nm) Green (525nm) Blue (470nm)	-10...55°C	NPN NO/NC PNP NO/NC	IP65	2m PVC cable
	SPM-TPR-RGB						
	SPM-TNR-WB	10±2mm	Visible white light/blue light visible red light/green light	-25°C...55°C	NPN NO+NC PNP NO+NC	IP65	2m PVC cable
	SPM-TNR-RG						
	SPM-TPR-WB						
	SPM-TPR-RG						



## SPN Series

Product image	Model	Detection distance	Light source	Ambient light	Spot size	Response time	Timer	Output mode
	SPN-BC50DEB-W	50...500mm	White LED	Incandescent lamp <10000lux Sunlight: <20000lux	3.5mm@10mm 9mm@250mm 20mm@500mm	0.2ms/ 1ms/ 10ms/ 100ms/ 500ms	Off/on delay/ off delay/ single shot	NPN+PNP NO/NC

Ultra-thin

Micro square

Little square

Large square

Round and square

Cylindrical

U shaped

Optical fiber

Color sensor

Color mark sensor

Label sensor

Naming rule



Official Website

## Photoelectric Sensors

## Label Sensor



For specifications, certification, usage and model list, please scan the product QR code.



Ultra-thin  
Micro square  
Little square  
Large square  
Round and square  
Cylindrical  
U shaped  
Optical fiber  
Color sensor  
Color mark sensor

## Product features

### Extremely high sensitivity and precision

Photoelectric/ultrasonic detection principle is optional, which can stably detect various tags. Support one-key setting, making debugging easier.

### High detection frequency

## Application



## Model specification

Product image	Model	Detection principle	Slot depth	Slot width	Label minimums pacing	Output method
	LAU-TR05TFB-E3	Ultrasonic	68mm	5mm	>2mm	NPN+PNP NO/NC
	LAP-TR03T□B-□	Photoelectric	60mm	3mm	>2mm	NPN NO/NC PNP NO/NC

Label sensor

Naming rule



Photoelectric

Ultra-thin

Micro square

Little square

Large square

Round and square

Cylindrical

U shaped

Optical fiber

Color sensor

Color mark sensor

**Label sensor**

Naming rule



# 04

## Measurement and Vision

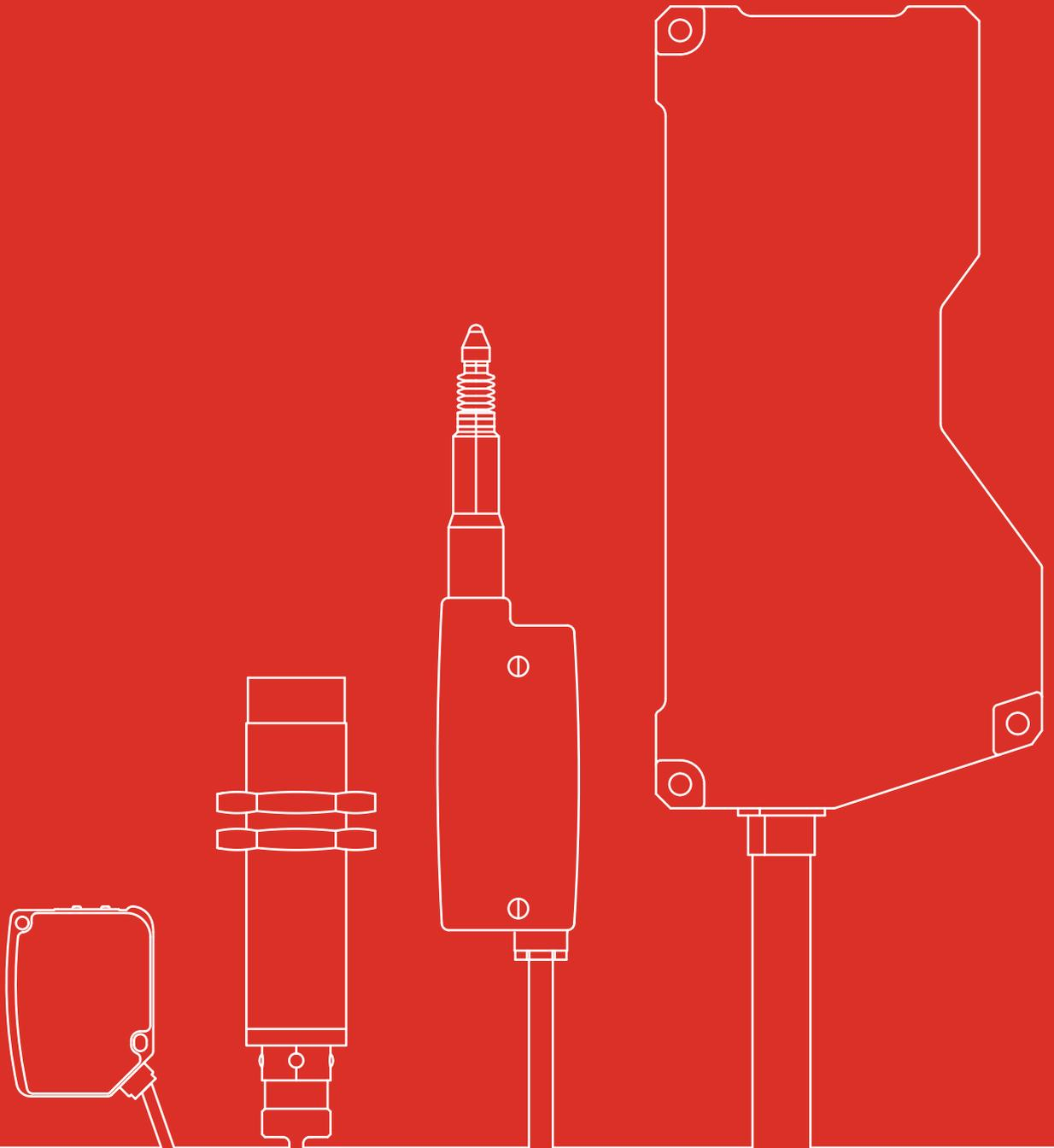

# Product Family

## Laser distance measuring sensor

OLED digital display, convenient operation, button/remote teach-in, multiple specifications available.



**D01-003** PDA/PDB

## Laser displacement sensor

OLED digital display, easy operation, small size with high precision, flexible output mode, multiple specifications available.



**D02-001** PDA/PDB/PDE

## CCD Laser diameter measuring sensor

Exquisite appearance, wide range, high precision, a variety of measurement modes, compatible with one-to-two, multi-controller cascading.



**D03-001** PDT/PDM

## 2D Laser scanner sensor

High-performance lidar to meet multiple applications widely used in manufacturing, warehousing, logistics, medical and service robot industries.



**D04-001** PDL

## LVDT displacement sensor

Digital/analog/RS485 optional, measurement accuracy reaches micron level.



**D05-001** LVR/LVA

## Ultrasonic sensor

With features as anti-pollution, anti-dust, anti-moisture, and strong penetration ability, widely used in fields like liquid level monitoring, robot anti-collision, single and double sheet detection, etc.



**D06-001** UR12/18/30  
US40

## Millimeter wave radar sensor

Long-distance and high-precision ranging to meet micro-change monitoring in complex environments.



**D07-001** MRA

## Code reader

Wide resolution coverage and multiple series to meet industrial-level information traceability needs.



**D08-001** PID

## 3D line scan sensor

In use of high-precision CMOS sensors and unique algorithms, with ultra high linear accuracy to realize non-cont.



**D09-001** PHM

# Laser Distance Measuring/ Displacement Sensors

PD E □ □ - C R100 T GR M - 3M □  
 ① ② ③ ④ ⑤ ⑥ ⑦ ⑧ ⑨ ⑩ ⑪

## 1. Classification code

PD: Optical measuring sensor

## 2. Shape code

A-Z:

e.g. A: a series, E: e series

## 3/4. Industry/Area

Factory definition

## 5. Measuring type

C: Laser displacement/distance measuring sensor

## 6. Sensing distance

R: mm, C: cm, M: m

For example:

R50: 50mm (for laser displacement series, indicating the center point of displacement)

C50: 50cm (For laser measuring series, indicating the maximum detection distance)

M2: 2m (for laser measuring series, indicating the maximum detection distance)

## 7. Supply voltage

D: 10...30V DC

T: 12...24V DC

## 8. Output

RS485+digital signal

Analog+digital signal

## 9. Special code

Blank: Standard part

A-Z:

M: High precision

## 10. Connection

Blank: Cable

A-Z: Connector

## 11. Special requirement

4 digits or letters

Laser distance measuring

Laser displacement

CCD line diameter measuring

2D laser scanner

LVDT displacement

Ultrasonic

Millimeter wave radar

Code reader

3D line scanner





For specifications, certification, usage and model list, please scan the product QR code.



## Product features

### Tiny laser spot

With good black and white color difference, easily deal with various targets.

### Accurate detection capabilities

Equipped with a high-precision CMOS sensor and a unique algorithm, ultra-high linearity enables non-contact and wear-free measurement.

### Flexible output ways

Built-in digital signal (NPN/PNP/PULL-PUSH) output +analog (4...20mA/0~10V/0~5V), or RS-485, supports MODBUS protocol.No need to connect with the controller, able to work independently, whether PLC or industrial computer, it can be easily connected.

### Powerful operating functions

Offering a wide range of measurement ranges and precision options, various modes and filter settings are available, along with zero-point setup, single-point, window teaching, and analog mapping functions, ensuring stable and flexible process control and detection.

## Application



Presence inspection of small packaging



Sensing/Monitoring of PCB stacker height

### Laser distance measuring

Laser displacement

CCD line diameter measuring

2D laser scanner

LVDT displacement

Ultrasonic

Millimeter wave radar

Code reader

3D line scanner

Naming rules



Official website



Laser  
distance  
measuringLaser  
displacementCCD line  
diameter  
measuring2D laser  
scannerLVDT  
displacement

Ultrasonic

Millimeter  
wave radar

Code reader

3D line  
scanner

Model	Output way	Measuring range	Linearity <sup>①②</sup>	Repeatability <sup>①②③</sup>	Resolution	Light spot size	Light source
PDA-CC10	RS-485 4...20mA	3...10cm	RS-485: ±0.3%F.S. 4...20mA: ±0.4%F.S.	10μm@30mm 30μm@50mm 100μm@100mm	5μm@30mm 50μm@100mm	1mm*3mm@100mm	Red laser laser level: Class 2
PDA-CC50		8...50cm	RS-485: ±0.3%F.S. 4...20mA: ±0.4%F.S.	30μm@80mm 250μm@250mm 1000μm@500mm	15μm@80mm 500μm@500mm	Φ2.5mm@500mm	
PDA-CC100		15...100cm	±0.6%F.S.	100μm@150mm 520μm@500mm 4000μm@1000mm	50μm@150mm 2000μm@1000mm	Φ3mm@1000mm	
PDB-CC10		3...10cm	RS-485: ±0.3%F.S. 4...20mA: ±0.4%F.S.	10μm@30mm 30μm@50mm 100μm@100mm	5μm@30mm 50μm@100mm	1mm*3mm@100mm	
PDB-CC50	8...50cm	RS-485: ±0.3%F.S. 4...20mA: ±0.4%F.S.	30μm@80mm 250μm@250mm 1000μm@500mm	15μm@80mm 500μm@500mm	Φ2.5mm@500mm		
PDB-CC100		15...100cm	±0.6%F.S.	100μm@150mm 520μm@500mm 4000μm@1000mm	50μm@150mm 2000μm@1000mm	Φ3mm@1000mm	
PDB-CM8	RS-485 4...20mA 0...10V	0.2...8m	±1%F.S.	±1%F.S.	1mm	90*90mm (at distance 5m)	Infrared laser Laser level: Class 3R

Note: Above products are all IP67 rated, and have digital display panels.

① Test conditions: standard data at 23±5°C.

② Statistical data follows the 3σ criterion.

③ Repeatability represents the statistical results of 100 data tests on 90% reflectivity white card in environment of 23±5°C.



Measurement and Vision

Laser distance measuring

Laser displacement

CCD line diameter measuring

2D laser scanner

LVDT displacement

Ultrasonic

Millimeter wave radar

Code reader

3D line scanner

Naming rules



Official website

# Laser Displacement Sensors



For specifications, certification, usage and model list, please scan the product QR code.



## Product features

### Flexible output ways

Supports multiple output modes of analog voltage, current output and digital signal.

### Faster, more stable, more accurate

Three optional response modes: standard, high-speed and high-precision detection modes.

### Accurate detection capabilities

Using high-precision CMOS sensors and unique algorithms, ultra-high linearity enables non-contact and wear-free measurement.

### Powerful operating functions

Equipped with a variety of ranges and precision options to choose from, different modes and filters can be set. Combined with zero-point setup, single point, window teaching, and analog mapping functions, it ensures stable and flexible process control and detection.

## Application

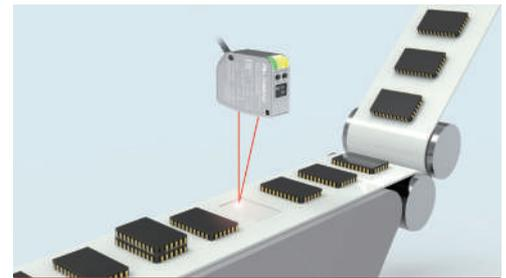

Determination of stacking or missing of chip components



Presence detection of cap gasket



Model	Output way	Measuring range	Linearity <sup>①②</sup>	Repeatability <sup>①②③</sup>	Resolution	Light spot size	Light source
PDA-CR30	RS-485 4...20mA	30±5mm (25...35mm)	RS-485: ±0.3%F.S. 4...20mA: ±0.4%F.S.	5μm	2.5μm@30mm	Φ0.5mm@30mm	Red laser laser level: Class 2
PDA-CR30		30±5mm (25...35mm)	±0.1%F.S.(-M series)	5μm	2.5μm@30mm	Φ0.5mm@30mm	
PDA-CR50		50±15mm (35...65mm)	RS-485: ±0.3%F.S. 4...20mA: ±0.4%F.S.	20μm	10μm@50mm	Φ0.5mm@50mm	
PDA-CR85		85±25mm (60...110mm)	RS-485: ±0.3%F.S. 4...20mA: ±0.4%F.S.	60μm	30μm@85mm	Φ0.5mm@85mm	
PDB-CR30	RS-485 4...20mA	30±5mm (25...35mm)	RS-485: ±0.3%F.S. 4...20mA: ±0.4%F.S.	5μm	2.5μm@30mm	Φ0.5mm@30mm	
PDB-CR50		50±15mm (35...65mm)	RS-485: ±0.3%F.S. 4...20mA: ±0.4%F.S.	20μm	10μm@50mm	Φ0.5mm@50mm	
PDB-CR85		85±25mm (60...110mm)	RS-485: ±0.3%F.S. 4...20mA: ±0.4%F.S.	60μm	30μm@85mm	Φ0.5mm@85mm	
PDE-CR50	RS-485 4...20mA + 0-5V	50±15mm (35...65mm)	±0.1%F.S.	30μm	10μm	Φ70μm@50mm	
PDE-CR100		100±35mm (65...135mm)	±0.1%F.S.	70μm	10μm	Φ120μm@100mm	
PDE-CR400		400±200mm 200...600mm	±0.2%F.S. (Sensing distance 200mm-400mm)  ±0.3%F.S. (Sensing distance 400mm-600mm)	300μm@200-400mm  800μm@400-600mm	100μm	Φ500μm@400mm	

Note: PDA/PDB are IP67 rated, PDE is IP65, and they all have digital display panels.

① Test conditions: standard data at 23±5°C.

② Statistical data follows the 3σ criterion.

③ Repeatability represents the statistical results of 100 data tests on 90% reflectivity white card in environment of 23±5°C.

④ PDE data is the value of the measurement center distance.

Laser  
distance  
measuring

Laser  
displacement

CCD line  
diameter  
measuring

2D laser  
scanner

LVDT  
displacement

Ultrasonic

Millimeter  
wave radar

Code reader

3D line  
scanner

Naming rules



Official website

# CCD Laser Diameter Measuring Sensors

PD   M   □   □ - T   C50   T   GR - □  
 ①   ②   ③   ④   ⑤   ⑥   ⑦   ⑧   ⑨

## 1. Classification code

PD: Optical measuring sensor

## 2. Shape code

One character: A-Z  
e.g. M,T

## 3. Measuring range

10: 10mm  
20: 20mm  
30: 30mm  
...

## 4. Industry/Area

Factory definition

## 5. Installation

T: Through beam

## 6. Sensing distance

R: mm  
C: cm  
M: m  
e.g. C50: 50cm

## 7. Supply voltage

D: 10...30V DC  
T: 12...24V DC

## 8. Output

RS485+digital signal  
Digital signal+Analog voltage  
Digital signal+Analog current  
Digital signal+Analog voltage/  
current

## 9. Special requirements

4 digits or letters

Laser  
distance  
measuring

Laser  
displacement

CCD line  
diameter  
measuring

2D laser  
scanner

LVDT  
displacement

Ultrasonic

Millimeter  
wave radar

Code reader

3D line  
scanner



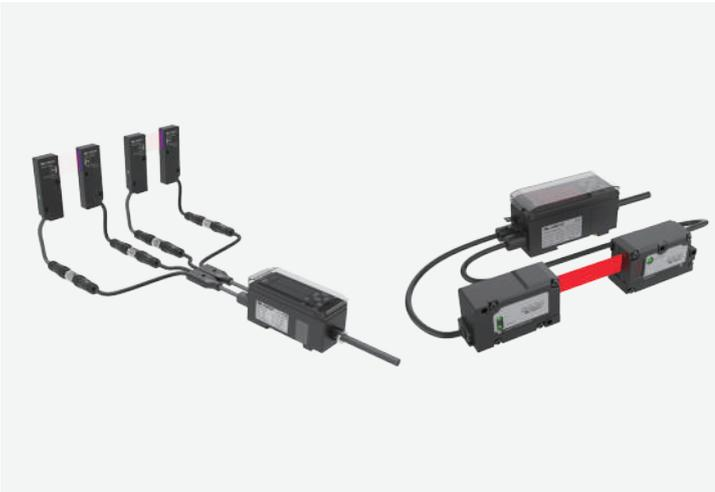

For specifications, certification, usage and model list, please scan the product QR code.



## Product features

- Compatible with one-to-two, EtherCAT networking
- Wide range, high-precision measurement, multiple modes available
- Small sensors and controllers save installation space
- Exquisite appearance, sturdy and lightweight aluminum casing
- Rich functions, easy to set up, and widely used

## Application



Winder edge-guiding detection

Laser distance measuring

Laser displacement

**CCD line diameter measuring**

2D laser scanner

LVDT displacement

Ultrasonic

Millimeter wave radar

Code reader

3D line scanner

Naming rules



Official website



### PDT series



Model	PDT series		
Measuring range	10mm	External input	CH1
Installation spacing	0...300mm	Digital output	CH1 output, PNP/NPN optional
Linearity	At 100mm distance	Analog output	CH1/CH2 output, analog voltage (0...10V output resistance 100 Ω)
Repeat accuracy	±10μm (Set distance: 100mm)	Resolution	1μm
Min. sensing object	Φ1mm (Set distance: 300mm)	Communication function	Controller, sensing head: RS485 bus
Light source	Red semiconductor laser Class 1	Number of connected units	1/2 pair
Supply voltage	12...24V DC	Operation temp	-10... 45°C (no freeze)
Sampling cycle	500μs	Ambient humidity	35...85%RH (no freeze)
Optical axis calibration indicator	Green LED (each for transmitter and receiver)	Protection grade	IP50
Alarm indicator	Red LED (receiver)		

### PDM series



Model	PDM series		
Measuring range	Width mode: 10mm; Edge mode: ±5mm	Linearity	±0.28%F.S.
Installation spacing	0...500mm	Repeatability	±10μm (set distance: 100 mm)
Min sensing object	Φ1mm (set distance: 500 mm)		±15μm (set distance: 500 mm)
Light source	Red laser; level: Class 1	Material	Casing: aluminium
Light spot size	14*12mm	Ambient temp	-10... 45°C (no condensation)
Temp drift	±0.08 %F.S./°C (±8μm/°C)	Ambient humidity	35...85%RH (no condensation)
Supply voltage	12...24V DC	Protection grade	IP50
Consumption current	≤900mA (incl. emitter and receiver)	Response time	2ms
Resolution	1 μm	Output 1	NPN NC
Display range	-99.999...99.999	Output 2	RS485 output
Display way	Double-digit 8-segment display; upper and lower levels: red, 6 digits		

Measurement and Vision

Laser distance measuring

Laser displacement

CCD line diameter measuring

2D laser scanner

LVDT displacement

Ultrasonic

Millimeter wave radar

Code reader

3D line scanner

Naming rules



Official website



# 2D Laser Scanner Sensors

PD L - C M20 D K - G1 □  
 ① ② ③ ④ ⑤ ⑥ ⑦ ⑧

## 1. Classification code

PD: Optical measuring sensor

## 2. Product type

L: 2D laser radar sensor

## 3. Application classification

C: Obstacle avoidance

D: Navigation type

S: Combined type

## 4. Sensing distance

M20: Sensing distance20@90%

M40: Sensing distance40@90%

M50: Sensing distance50@90%

## 5. Supply voltage

D: 10...30V DC

## 6. Output

K: Relay

W: Ethernet-UDP

## 7. Connection

G1: M12 12-pins+0.45m cable

G2: M12 4-pins+0.45m cable

M12 4-pins D-coded network  
port+0.45m cable

G3: M12 12 pins+0.45m cable,  
M12 4-pins D-coded network  
port+0.45m cable

## 8. Special requirements

4 digits or letters

Laser  
distance  
measuring

Laser  
displacement

CCD line  
diameter  
measuring

2D laser  
scanner

LVDT  
displacement

Ultrasonic

Millimeter  
wave radar

Code reader

3D line  
scanner





### Product features

#### High quality point cloud

Extremely high angular resolution; Ideal for precise positioning of reflectors.

#### Consistent and reliable

Customized testing fixtures; High-standard test methods; Multiple third-party certifications

#### Excellent environmental performance

Stable detection of dark color objects; High resistance to ambient light; Adaptable to a variety of unconventional application scenarios.

#### Convenient software configuration

Simple software configuration saves configuration time.

### Model Specification

Model	Sensing distance	Scan angle	Angle resolution	Accuracy	Switchable area*output	Data output/ configure port
PDL-SM40DW-G3	15m@10% 40m@90%	360°	0.0144°@10Hz, 0.0216°@15Hz, 0.0288°@20Hz, 0.0360°@25Hz, 0.0432°@30Hz, 0.1°@35/40/45Hz, 0.2°@50Hz O ptional	±20mm	16*3	Ethernet UDP
PDL-DM50DW-G2	20m@10% 50m@90%	270°	0.1°@10Hz, 0.2°@20Hz, 0.3°@30Hz, 0.33°@15Hz O ptional		/	
PDL-CM20DK-G1	10m@10% 20m@90%	270°	0.1°@10Hz, 0.15°@15Hz, 0.2°@20Hz, 0.25°@25Hz, 0.3°@30Hz O ptional	±25mm	8*3	TYPE-C

### Application



Navigation and Obstacle Avoidance in AGV Material Handling Processes

Laser distance measuring

Laser displacement

CCD line diameter measuring

2D laser scanner

LVDT displacement

Ultrasonic

Millimeter wave radar

Code reader

3D line scanner

Naming rules



Official website

# LVDT Displacement Sensors

## Combined amplifier naming rules

LV A - E S G B U D1 - □ □  
 ① ② ③ ④ ⑤ ⑥ ⑦ ⑧ ⑨ ⑩

### 1. Classification code

LV: LVDT displacement sensor

### 2. Structure type

A: Amplifier

### 3. Housing shape

E: Square

R: Cylindrical

### 4. Housing material

Blank: Metal

S: Plastic

### 5. Output

N: NPN

P: PNP

E: NPN/PNP

F: NPN+PNP

G: NPN/PNP+RS485

H: NPN/PNP+RS232

J: NPN/PNP+Analog

K: Relay

R: RS485

R2: RS232

### 6. Digital signal output

O: NO

C: NC

B: NO+NC

### 7. Analog output status

I: Analog voltage (0...20mA)

I4: Analog voltage (4...20mA)

U: Analog current (0...10V)

U5: Analog current (0...5V)

### 8. Digital display type

Blank: No synchronization  
function

S: With synchronization function

### 9. Module type

M: Master module

E: Extension module

### 10. Special requirements

4 digits or letters

Laser  
distance  
measuring

Laser  
displacement

CCD line  
diameter  
measuring

2D laser  
scanner

LVDT  
displacement

Ultrasonic

Millimeter  
wave radar

Code reader

3D line  
scanner



## Sensing probe naming rules



### 1. Classification code

LV: LVDT displacement sensor

### 2. Structure type

P: Pencil-style  
R: Spring-return  
S: Core-separable LVDT probe

### 3. Housing size

Blank: Standard  
S: Short

### 4. Housing material

Blank: Metal copper  
G: Stainless steel  
S: Plastic  
V: Slluminium

### 5. Measuring range

M05: 5mm  
M10: 10mm  
M15: 15mm  
M20: 20mm

### 6. Supply voltage

(only for combined series)

D: 10...30V DC  
T: 12...24V DC

### 7. Output interface

R: RS485 output  
I: Analog voltage (4...20mA)  
U: Analog current (0...10V)

### 8. Repeatability

01: 0.1%  
11: 0.01%

### 9. Connection

Blank: 2m cable  
xM: x meters cable (x: number)  
e.g. 3M: 3m cable

E1: M8 3-pins  
E2: M12 4-pins  
E3: M8 4-pins  
E4: M12 4-pins trapezoidal connector  
E5: M12 5-pins

### 10. Special requirements

4 digits or letters

Laser distance measuring

Laser displacement

CCD line diameter measuring

2D laser scanner

LVDT displacement

Ultrasonic

Millimeter wave radar

Code reader

3D line scanner



# LVDT Displacement Sensors



For specifications, certification, usage and model list, please scan the product QR code.



## Product features

- Micrometer-level repeatability
- Multiple ranges available from 5...20mm
- Comprehensive output options, including digital signal, analog, and RS485
- Low as 3N sensing head pressure, capable of non-abrasive detection on both metal and glass surfaces
- Rich exterior dimensions to meet various application spaces

## Application



Wafer flatness inspection

## Model Specification

Appearance	Type	Part name	Model	Range	Linearity	Repeatability	Output way	Protection grade
	Combined type	Amplifier	LVA-ESJB14D1M	/	/	/	4-20mA current, three ways digital output	IP40
		Sensing probe	LVR-VM15R01	0...15mm	±0.2%F.S. (25°C)	8μm (25°C)	/	/
			LVR-VM10R01	0...10mm				
	Integrated type	Integrated sensing probe	LVR-VM20DR01	0...20mm	±0.25%F.S. (25°C)	8μm (25°C)	RS485	IP65
			LVR-VM15DR01	0...15mm				
			LVR-VM10DR01	0...10mm				
			LVR-VM5DR01	0...5mm				
			LVR-SVM10DR01	0...10mm				



Measurement  
and Vision

Laser  
distance  
measuring

Laser  
displacement

CCD line  
diameter  
measuring

2D laser  
scanner

**LVDT  
displacement**

Ultrasonic

Millimeter  
wave radar

Code reader

3D line  
scanner

Naming rules



Official website

# Ultrasonic Sensors

U R 18 S - C C30 D N B S - E5  
 ① ② ③ ④ ⑤ ⑥ ⑦ ⑧ ⑨ ⑩ ⑪

## 1. Classification code

U: Ultrasonic sensor

## 2. Housing shape

R: Cylindrical  
S: Square

## 3. Housing size

Number: 0-99mm

## 4. Housing material

Blank: Copper-Nickel Alloy  
G: Stainless steel  
S: Plastic

## 5. Function type

C: Reflection  
D: Single-double sheet

## 6. Sensing distance

C50: 50cm  
M2: 2m

## 7. Supply voltage

D: 24V DC

## 8. Output way

3N: 3 NPN  
3P: 3 PNP  
(Above for single-double sheet only)

N: NPN  
P: PNP  
2N: 2 NPN  
2P: 2 PNP  
I: 4...20mA  
IU: 4...20mA+0...10V  
R4: RS485  
U5: 0...5V  
U10: 0...10V  
NR4B: NPN+RS485  
PR4B: PNP+RS485

## 9. Mode

O: NO  
C: NC  
B: NO+NC  
H: Hysteresis mode

## 10. Synchronization function

Blank: no synchronization function  
S: With synchronization function

## 11. Connection

Blank: 2m cable  
E1: M8 3-pins  
E2: M12 4-pins  
E3: M8 4-pins  
E5: M12 5-pins

Laser  
distance  
measuring

Laser  
displacement

CCD line  
diameter  
measuring

2D laser  
scanner

LVDT  
displacement

Ultrasonic

Millimeter  
wave radar

Code reader

3D line  
scanner





For specifications, certification, usage and model list, please scan the product QR code.



## Product features

### Strong resistance to environmental interference

Used in various lighting environments, it offers reliable performance under indoor, outdoor, and complex ambient light conditions.

### Long sensing distance

Ultrasonic waves can propagate in different media and have a long detection distance, up to 6m.

### A variety of output ways available

Supports multiple outputs such as digital signal, analog, RS485 communication, etc.

### IP67 Protection degree

IP67 Protection degree, resistant to dirt, dust, and moisture, suitable for harsh outdoor environments.

### Single/double sheet detection function

Reliable detection of air, single and double sheets.

## Application

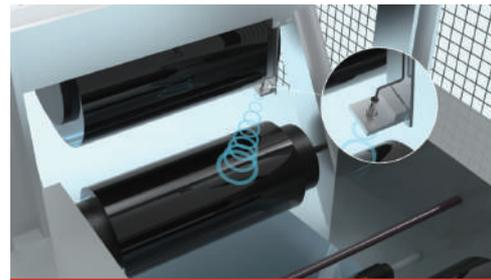

Conveyor Metal Component Inspection

Laser distance measuring

Laser displacement

CCD line diameter measuring

2D laser scanner

LVDT displacement

**Ultrasonic**

Millimeter wave radar

Code reader

3D line scanner

Naming rules



Official website

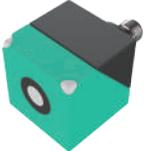

## Distance measuring series

Appearance	Model	Output way	Sensing distance	Frequency	Resolution	Supply voltage	Connection
	UR18-CC15	NPN/PNP NO/NC NPN/PNP hysteresis mode	20...150mm	20Hz	0.17mm	20...30V DC	M12 4 pins connector
	UR18-CC35	0...5V analog output 0...10V analog output 4...20mA analog output	30...350mm				
	UR18-CC50	40...500mm					
	UR18-CM1	NPN/PNP NO/NC NPN/PNP hysteresis mode 0...5V analog output 0...10V analog output 4...20mA analog output	60...1000mm	10Hz	0.5mm	20...30V DC	Cable M12 4 pins connector
		2 ways NPN/PNP NO/NC NPN/PNP+RS 485	60...1000mm	10KHZ	0.5mm	20...30V DC	M12 5 pins connector
	UR30-CC50		50...500mm	20Hz	0.5mm	12...30V DC	M12 5 pins connector
	UR30-CM2	NPN/PNP NO/NC NPN/PNP hysteresis mode 0...5V analog output 0...10V analog output 4...20mA analog output	120...2000mm	10Hz	0.5mm	12...30V DC	M12 4 pins connector
			180...2000mm	10Hz	1mm	20...30V DC	Cable
	UR30-CM3		180...3000mm	10Hz	1mm	20...30V DC	Cable M12 4 pins connector
	UR30-CM4	200...4000mm	3Hz	1mm	12...30V DC		
	UR30-CM6	NPN/PNP NO/NC	350...6000mm	3Hz	4mm	12...30V DC	M12 4 pins connector
		0...5V analog output 0...10V analog output 4...20mA analog output				0...5V: 12...30V DC 0...10V: 20...30V DC 4...20mA: 12...30V DC	
		NPN/PNP+RS485				10...30V DC	M12 5 pins connector
	US40-CC50	NPN/PNP NO/NC NPN/PNP hysteresis mode 0...5V analog output 0...10V analog output 4...20mA analog output	40...500mm	20Hz	0.17mm	20...30V DC	M12 4 pins connector

Laser  
distance  
measuringLaser  
displacementCCD line  
diameter  
measuring2D laser  
scannerLVDT  
displacement

Ultrasonic

Millimeter  
wave radar

Code reader

3D line  
scanner

Naming rules



Official website

Single-double sheet series

Appearance	Model	Output way	Sensing distance	Frequency	Resolution	Supply voltage	Connection
	UR12-DC40	3 ways NPN/PNP NO/NC	20...40mm	/	1mm	18...30V DC	Cable
	UR18-DC60		30...60mm				
	UR30-DC40		20...40mm				

Laser distance measuring

Laser displacement

CCD line diameter measuring

2D laser scanner

LVDT displacement

**Ultrasonic**

Millimeter wave radar

Code reader

3D line scanner

Naming rules



Official website

# Millimeter Wave Radar Sensors

MR A 80 D 20 D G - B 0

① ② ③ ④ ⑤ ⑥ ⑦ ⑧ ⑨

## 1. Classification code

MR: Millimeter wave  
radar sensor

## 2. Product series

A: A series

## 3. Waveband

80: 80GHz  
120: 120GHz

## 4. Measuring mode

D: Distance measurement  
V: Speed measurement

## 5. Measuring range

20: 20m  
30: 30m

## 6. Supply voltage

D: 10...30V DC

## 7. Output

G: PushPull/NPN/PNP  
R: RS485  
I: 4...20mA  
U: 0...10V  
L: IO-Link

## 8. Working principle

B: Reflection

## 9. Special requirements

4 digits or letters

Laser  
distance  
measuring

Laser  
displacement

CCD line  
diameter  
measuring

2D laser  
scanner

LVDT  
displacement

Ultrasonic

Millimeter  
wave radar

Code reader

3D line  
scanner

## Naming rules





## Product features

### Compact size, high precision

A repeatability superior to  $\pm 1\text{mm}$  for distance within 100m.

### Multiple communication methods

With selectable RS485, analog, and digital interfaces, supporting remote data analysis.

### Strong anti-interference capability

Suitable for various harsh environments and extreme weather conditions, such as mines, oil tanks, etc.

### IP68 Protection degree

## Application



Open tank level measurement

## Model Specification

Model	Emitting frequency (Hz)	Measured distance	Horizontal antenna direction	Vertical antenna direction	Repeatability	Refresh rate	Output way
MRA80D20DXX-B	80G	20m	$\pm 3^\circ$	$\pm 3^\circ$	$\pm 1\text{mm}$	30Hz	1...20m+RS484+ 2*NPN/PNP NO/NC
MRA120D30DXX-B	120G	30m					

Laser distance measuring

Laser displacement

CCD line diameter measuring

2D laser scanner

LVDT displacement

Ultrasonic

**Millimeter wave radar**

Code reader

3D line scanner

Naming rules



Official website

# Code Reader

PID - B 30 80 □ - 05 H - W □  
 ① ② ③ ④ ⑤ ⑥ ⑦ ⑧ ⑨

## 1. Classification code

PID: Code reader

## 2. Product type

B: Basic

P: Intelligent

## 3. Product series

20: 2000 series

30: 3000 series

## 4. Resolution

004: 0.4 MP

010: 1 MP

013: 1.3 MP

016: 1.6 MP

060: 6 MP

200: 20 MP

## 5. Shutter type

G: Special

R: Global shutter

X: Rolling shutter

## 6. Lens focal length

00: Mirrorless

05: 5mm

06: 6mm

08: 8mm

12: 12mm

16: 16mm

25: 25mm

## 7. Lens mount

Default: Fixed focus

C: C mount

F: F

H: Manual

L: C mount

M: Motorized Focus

S: CS

## 8. Light source color

B: Blue

G: Green

R: Red

I: Infrared

M: Multicolor

N: No fill light

W: White

RW: Two color

## 9. Performance

F: Full polarization

H: Half polarization

N: Normal

V: Vericode

(LCD panel QR code scanning technology)

Laser  
distance  
measuring

Laser  
displacement

CCD line  
diameter  
measuring

2D laser  
scanner

LVDT  
displacement

Ultrasonic

Millimeter  
wave radar

Code reader

3D line  
scanner





### Product features

**Comprehensive models, wide application range**  
 100...800W wide pixel distribution, capable for multiple scenes.

**Rich interfaces**  
 With physical communication interfaces such as Ethernet, serial ports, and USB, enabling seamless communication with devices like PCs and PLCs.

**One-click adjustment, intelligent recognition**  
 A single button for automatic focus adjustment, parameter acquisition, and autonomous recognition of multiple types of codes.

### Application

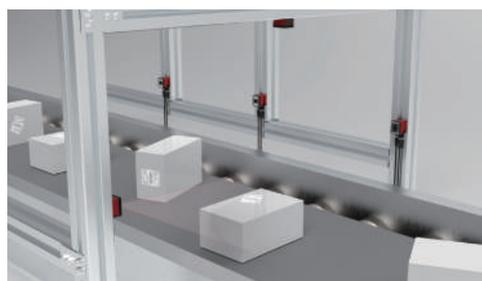

Six face code scan

### Model Specification

Type	Model	Pixel	Resolution	Frame rate	Focus adjustment
Basic	PID-B2010G-06	1 Millon	1280*800	50fps	Fixed focus
	PID-B2023G-06	2.3 Millon	1920*1200	40fps	
	PID-B2010G-06H	1 Millon	1280*800	50fps	Manual
	PID-B2023G-06H	2.3 Millon	1920*1200	40fps	
	PID-B3010G-□□M	1 Millon	1280*800	60fps	Fixed focus
	PID-B3023G-□□M	2.3 Millon	1920*1280	40fps	
	PID-B3050G-□□M	5 Millon	2448*2048	30fps	
	PID-B3080R-□□M	8 Millon	3840*2144	15fps	
Intelligent	PID-P2013G-05	1.3 Millon	1280*1024	50fps	Fixed focus
	PID-P2013G-05H				Manual
	PID-P3013X-□□M	1.3 Millon	1280*1024	60fps	Fixed focus
	PID-P3013G-□□M				
	PID-P3016G-□□M	1.6 Millon	1440*1080	60fps	
	PID-P3050G-□□M	5 Millon	2368*1792	45fps	
	PID-P3060G-□□M	6 Millon	3072*2048	40fps	

Note: 1. Customization is supported (customizable barcode rating, data analysis etc.)

Laser distance measuring

Laser displacement

CCD line diameter measuring

2D laser scanner

LVDT displacement

Ultrasonic

Millimeter wave radar

Code reader

3D line scanner

Naming rules



Official website

# 3D Line Scan Sensors

PHM 2 050

①      ②      ③      ④

## 1. Classification code

PHM: 3D line scan sensor

## 2. Product series

2: 2000 series

6: 6000 series

## 3. Z-axis measurement range

008: 8mm

030: 30mm

050: 50mm

080: 80mm

230: 230mm

300: 300mm

## 4. Special requirements

4 digits or letters

Laser  
distance  
measuring

Laser  
displacement

CCD line  
diameter  
measuring

2D laser  
scanner

LVDT  
displacement

Ultrasonic

Millimeter  
wave radar

Code reader

3D line  
scanner

## Naming rules





For specifications, certification, usage and model list, please scan the product QR code.



### Product features

#### Ultra-high resolution

Each contour is meticulously analyzed, capturing 4096 data points, accurately addressing subtle depressions and protrusions and fully restoring the true contour of the object.

#### Ultra high scan rate

Full line width scan at an ultra-high scan speed up to 15kHz significantly increases the inspection speed.

#### Multiple models, wide applications

Satisfying various scenarios.

#### With software, visual applications are easily accomplished

Graphical interface, no coding required, with an integrated debugging and deployment process.

### Application

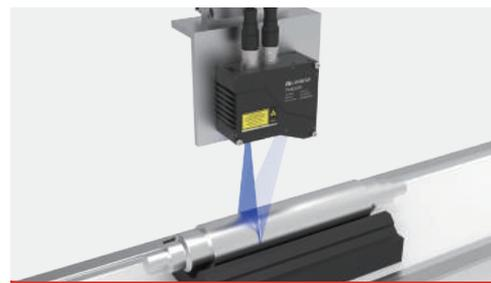

Automotive component dimension inspection

Laser distance measuring

Laser displacement

CCD line diameter measuring

2D laser scanner

LVDT displacement

Ultrasonic

Millimeter wave radar

Code reader

3D line scanner

### Model Specification

Model	Contour points	Reference distance	Z-axis measurement range	X-axis resolution	Z-axis repeatability	Scan rate	Light source
PHM2008	1280	20mm	8mm	7μm	±1.1μm	0.12...2kHz	Blue laser (405nm, 3R)
PHM2050		125mm	50mm	40.5μm	±10μm		
PHM2230		305mm	230mm	150μm	±20μm		
PHM6030	4096	78mm	30mm	9μm	±0.1μm	3.3...15kHz	Blue laser (405nm, class 2M)
PHM6080		250mm	100mm	23.5μm	±0.25μm		
PHM6300		325mm	305mm	105μm	±1μm		

Naming rules



Official website



# 05

## Safety and Control

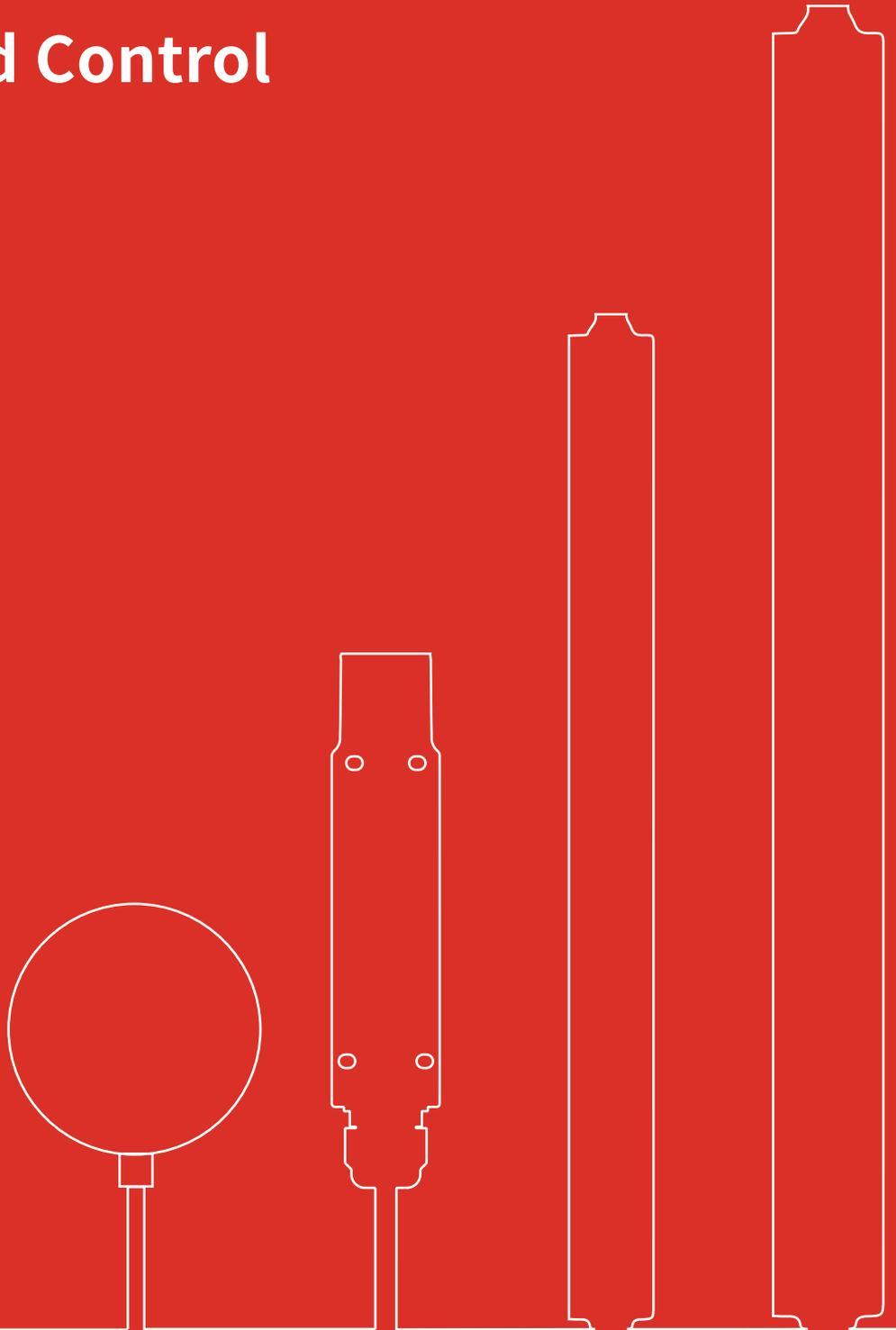

# Product Family

---

## Light curtain

SFx series high-level safety protective light curtains are widely used in forging and stamping industries, automotive manufacturing and electrical and electronics manufacturing industries.

MHxx series measuring light curtains can measure the size of objects and are extensively used in product quality inspection and passing detection.

**E01-003** SFB/SFE/SFG/SFN/SFS  
MH20/MH40



## Safety door switch

Combining ease of use and reliability, with various sizes and contact points available for selection.

**E02-001** SLB-D/SLC-D/SLAS-D/SLD/Operation keys



## Encoder

Applied to machine tool feed axes, servo motion control, and industrial robots, the encoder features high rigidity, high response, and high positioning accuracy.

**E03-001** ENI38K/38S/50S/58K/58S  
ENA39S/58S



# Light Curtain

## Safety light curtain naming rule

SF N 40 □□□ - T M05 D N C - □  
 ① ② ③ ④ ⑤ ⑥ ⑦ ⑧ ⑨ ⑩

### 1. Classification code

SF: Safety light curtain

### 2. Appearance code

B: B series

E: E series

G: G series

N: N series

S: S series

### 3. Beam space

Number:

e.g. 5mm/10mm/15mm/

20mm/40mm

Note: There will be differences in different product series, please refer to the corresponding product information for details

### 4. Beam quantity

3 digits

e.g. 008: 8 beams

012: 12 beams

016: 16 beams

144: 144 beams

### 5. Detection principle

T: Through beam

### 6. Detection range

M02: 2m

M05: 5m

M06: 6m

### 7. Operation voltage

D: 10...30V DC

T: 12...24V

### 8. Output

N: NPN

P: PNP

E: NPN/PNP

F: NPN+PNP

K: relay

### 9. Output logic

C: Normally closed

### 10. Special requirement

4 digits or letters

## Measuring light curtain naming rule

M H 20 - T □□ □□ L - F2  
 ① ② ③ ④ ⑤ ⑥ ⑦ ⑧

### 1. Classification code

M: Measuring light curtain

### 2. Appearance code

H: 47\*36mm

### 3. Beam space

Number:

e.g. 20: 20mm

### 4. Detection principle

T: Through beam

### 5. Beam quantity

08: 8 beams

16: 16 beams

24: 24 beams

32: 32 beams

40: 40 beams

48: 48 beams

56: 56 beams

64: 64 beams

112: 112 beams

### 6. Detection range

Number:

02: 2m; 03: 3m

...

### 7. Operation voltage

L: 15...30V DC

### 8. Connection method

F2: M12 4-pins connector

F8: M12 8-pins connector

Light curtain

Safety door  
Switch

Encoder

Naming rules



Official website



For specifications, certification, usage and model list, please scan the product QR code.



### Products features

- Fast response
- Compact size
- Easy to install and operate
- Strong anti-electromagnetic interference ability
- Adopting line synchronization technology, it can effectively avoid external infrared light interference

### Application

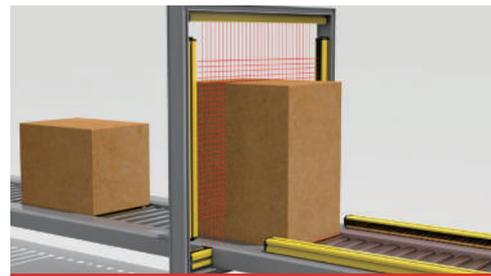

Light curtain

Safety door Switch

Encoder

### Model specification

#### ■ Safety light curtain

Model	SFB series	SFE series	SFG series
Dimension	28*13mm	35*53mm	35*27mm
Detection range	0.1...2m	0.1...5m	0.1...5m
Safety level	TYPE 2	TYPE 4	TYPE 2
Beam quantity	10mm space: 8, 12, 16...128; 20mm space: 4, 6, 8...64; 40mm space: 4, 6, 8...32	20mm space: 4, 6, 8, 10...122; 40mm space: 4, 6, 8, 10...36	10mm space: 8, 12, 16...144; 20mm space: 4, 6, 8...72; 40mm space: 4, 6, 8...36
Protection level	IP54	IP65	IP65
Response time	(N*0.1ms) + 0.4ms (N=beam quantity)	<10ms	(N*0.1ms) + 0.4ms (N=beam quantity)
Connection	Cable	GA Aviation connector	GX12 Aviation connector
Beam space	10mm, 20mm, 40mm		
Output	NPN NC/PNP NC		
Synchronous mode	Line Synchronization		

Naming rules



Official website

Model	SFN series	SFS series
Dimension	35*50mm	25*25mm
Detection range	0.1...5m, 0.1...10m; 0.1...30m (10mm space: 8...160 beams, 20mm space: 4...80 beams, 40mm space: 4...76 beams)	0.1...6m
Safety level	TYPE 2	TYPE 2
Beam quantity	10mm space: 8, 12, 16...320 20mm space: 4, 6, 8...160 40mm space: 4, 6, 8...120	20mm space: 8, 12, 16, 16, 20...96 40mm space: 4, 6, 8...48
Protection level	IP65	IP65
Response time	(N*0.1ms) + 0.4ms (N=beam quantity)	(N*0.1ms) + 0.4ms (N=beam quantity)
Connection	GX16 Aviation connector	0.35m cable+GX12 Aviation connector
Beam space	10mm, 20mm, 40mm	20mm, 40mm
Output	NPN NC/PNP NC	NPN NC/PNP NC
Synchronous mode	Line Synchronization	Optical synchronization

## Measuring light curtain

Model	MH20 series				
Protect height	300mm	620mm	940mm	1260mm	2200mm
Response time	5ms	10ms	15ms	18ms	24ms
Beam quantity	16mm	32mm	48mm	64mm	112mm
Detection range	0...5m				
Beam space	20mm				
Output	Two-way NPN/PNP, NC/NO configurable + RS485				
Protection level	IP65				
Connection	Transmitter: M12 connector (4-pins); Receiver: M12 connector (8-pins)				

Model	MH40 series					
Protect height	280mm	600mm	920mm	1240mm	1560mm	2200mm
Response time	5ms	10ms	15ms	18ms	19ms	24ms
Beam quantity	8mm	16mm	24mm	32mm	40mm	56mm
Detection range	0...5m					
Beam space	40mm					
Output	Two-way NPN/PNP, NC/NO configurable + RS485					
Protection level	IP65					
Connection	Transmitter: M12 connector (4-pins); Receiver: M12 connector (8-pins)					

Light curtain

Safety door switch

Encoder

Naming rules



Official website

Safety and Control

Light curtain

Safety door switch

Encoder

Naming rules



Official website

---

Area with horizontal dashed lines for writing.

# Safety Door Switch

SL A S □ □ - M T 1A 2D L - □  
 ① ② ③ ④ ⑤ ⑥ ⑦ ⑧ ⑨ ⑩ ⑪

## 1. Classification code

SL: Safety door switch

## 2. Appearance code

A: Small  
B: Medium  
C: Large  
D: Flat

## 3. Detection head material

M: metal  
S: plastic

## 4/5. Industry/ area code

Factory definition

## 6. Lock way

E: Electromagnetic lock  
M: Mechanical lock

## 7. Operationn voltage (electromagnet)

T: 24V DC

## 8. Interlock contact output

Blank: No contact  
1A: 1-way NO output  
2B: 2-way NC output  
3A: 3-way NO output  
3B: 3-way NC output  
E: NO/NC

## 9. Protective contact lock output

Blank: No contact  
1C: 1 NO output  
2D: 2 NC outputs  
3C: 3 NO outputs  
3D: 3 NC outputs  
F: NO/NC  
R: NO+NC

## 10. Unlocking device

Blank: No back unlocking  
L: Back unlocking  
F: Front emergency unlocking  
S: Side emergency unlocking

## 11. Special requirements

4 digits or letters

Light curtain

Safety door switch

Encoder

Naming rules



Official website

# SLB Series Electromagnetic Lock Safety Door Switch



## Products features

- 6 sets of gold-plated contacts
- 14 types of contact combinations
- Locking force 1300N
- Indicator light + emergency unlocking
- 11 types of operating keys
- Compact design saves installation space

## Application



Light curtain

Safety door switch

Encoder

## Model specification

Model	Door monitoring contacts + locking monitoring contacts	Lock & unlock method	Tensile strength	Security level	Rated operating voltage/current of contact element
SLB□-ET1B1D	1NC + 1NC	Power lock / Power-off unlock	1300N	Ple/Cat4 kinds Type 2 kinds	AC-15: Ue/Ie (240V/3A) DC-13: Ue/Ie (30V/2.3A)
SLB□-ET2D	N/A + 2NC				
SLB□-ET2B	2NC + N/A				
SLB□-ET1F	1NC/1NO + N/A				
SLB□-ET1A1C	1NO+ 1NC				
SLB□-ET1F	N/A + 1NC/1NO				
SLB□-MT1B1D	1NC + 1NC	Power-off lock / Power release	1300N	Ple/Cat4 kinds Type 2 kinds	AC-15: Ue/Ie (240V/3A) DC-13: Ue/Ie (30V/2.3A)
SLB□-MT2D	N/A + 2NC				
SLB□-MT2B	2NC + N/A				
SLB□-MT1F	1NC/1NO + N/A				
SLB□-MT1A1C	1NO+ 1NC				
SLB□-MT1F	N/A + 1NC/1NO				

Note: The operation voltage of the electromagnet of the above products is DC24V±5%, and the protection level is IP67.

Naming rules



Official website



# SLC Series Electromagnetic Lock Safety Door Switch



## Products features

- 6 sets of gold-plated contacts
- 14 types of contact combinations
- Locking force 1300N
- Indicator light + emergency unlocking
- Rear unlock function optional
- 11 types of operating keys

## Application



Model	Door monitoring contacts + locking monitoring contacts	Lock & unlock method	Tensile strength	Security level	Rated operating voltage/current of contact element	
SLC□-ET1E1F□	1NC/1NO+1NC/1NO	Power lock / Power-off unlock	1300N	Ple/Cat4 kinds Type 2 kinds	AC-15: Ue/Ie (240V/3A) DC-13: Ue/Ie (30V/2.3A)	
SLC□-ET1F2D□	1NC/1NO+2NC					
SLC□-ET2B1F□	2NC+1NC/1NO					
SLC□-ET2B2D□	2NC+2NC					
SLC□-ET1E1F□	1NC/2NO+1NC					
SLC□-ET3B1D□	3NC+1NC					
SLC□-ET2E1D□	2NC/1NO+1NC					
SLC□-ET1B3D□	1NC+3NC					
SLC□-ET1B1F□	1NC+1NC/2NO					
SLC□-ET1B2F□	1NC+2NC/1NO					
SLC□-ET1A3D□	1NO+ 3NC					
SLC□-ET1A2F□	1NO+2NC/1NO					
SLC□-ET2B2C□	2NC+2NO					
SLC□-ET2A2D□	2NO+2NC					
SLC□-MT1E1F□	1NC/1NO+1NC/1NO					Power-off lock / Power release
SLC□-MT1E2D□	1NC/1NO+2NC					
SLC□-MT2B1F□	2NC+1NC/1NO					
SLC□-MT2B2D□	2NC+2NC					
SLC□-MT1E1D□	1NC/2NO+1NC					
SLC□-MT3B1D□	3NC+1NC					
SLC□-MT2E1D□	2NC/1NO+1NC					
SLC□-MT1B3D□	1NC+3NC					
SLC□-MT1B1F□	1NC+1NC/2NO					
SLC□-MT1B2F□	1NC+2NC/1NO					
SLC□-MT1A3D□	1NO+ 3NC					
SLC□-MT1A2F□	1NO+2NC/1NO					
SLC□-MT2B2C□	2NC+2NO					
SLC□-MT2A2D□	2NO+2NC					

Note: The operation voltage of the electromagnet of the above products is DC24V±5%, and the protection level is IP67.

Light Curtain

Safety door switch

Encoder

Naming rules



Official website

# SLD Series Electromagnetic Lock Safety Door Switch



Light curtain

Safety door switch

Encoder

## Products features

- 6 sets of gold-plated contacts
- 4 types of contact combinations
- Locking force 1300N
- Indicator light + emergency unlocking
- Front/side emergency unlocking optiona
- 11 types of operating keys

## Application



## Model specification

Model	Door monitoring contacts + locking monitoring contacts	Lock & unlock method	Tensile strength	Security level	Rated operating voltage/current of contact element
SLD□-ET2E2F□	2NC/1NO+2NC/1NO	Power lock / Power-off unlock	1300N	Ple/Cat4 kinds Type 2 kinds	AC-15: Ue/Ie (240V/3A) DC-13: Ue/Ie (30V/2.3A) DC-13: Ue/Ie (250V/0.27A)
SLD□-ET3B2F□	3NC+2NC/1NO				
SLD□-ET2E3D□	2NC/1NO+3NC				
SLD□-ET3B3D□	3NC+3NC				
SLD□-MT2E2F□	2NC/1NO+2NC/1NO	Power-off lock / Power release			
SLD□-MT3B2F□	3NC+2NC/1NO				
SLD□-MT2E3D□	2NC/1NO+3NC				
SLD□-MT3B3D□	3NC+3NC				

Note: The operation voltage of the electromagnet of the above products is DC24V±5%, and the protection level is IP67.

Naming rules



Official website

# SLAS Series Safety Door Switch



## Products features

- Full range of gold-plated contacts, suitable for standard loads and micro loads
- Up to 3 sets of contact structures, optional 2NC+1NO or 3NC
- NC contacts are direct disconnection contacts
- 8 ways to insert the operating key can be adjusted to meet different installation positions
- Universal use of operating keys and electromagnetic lock safety door switches
- Original factory comes with PG13.5 cable connector

## Application

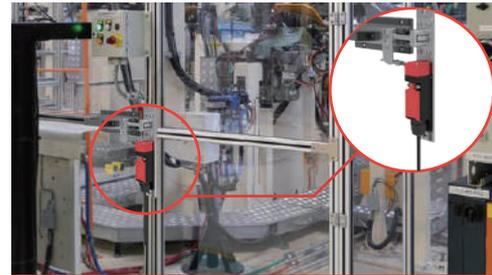

Light curtain

Safety door switch

Encoder

## Model specification

Model	Door monitoring contacts + locking monitoring contacts	Lock & unlock method	Tensile strength	protection degree	Rated operating voltage/current of contact element
SLAS-MT1R	1NC+1NC	/	/	IP65/IP67	AC-15: Ue/Ie (400V/2A)
SLAS-MT2B	2NC				
SLAS-MT2R	2NC+1NC				
SLAS-MT3C	3NC				

Naming rules



Official website

Safety Door Switch

# Operation key & Dimension

### ZJP-K1

T-type operation key



### ZJP-K1s

T-type operation key-with cushion



### ZJP-K2

L-type operation key



### ZJP-K2s

T-type operation key-with cushion



### ZJP-K3

Long T-type operation key



### ZJP-K3s

Long T-type operation key-with cushion



### ZJP-K4

Long L-type operation key



### ZJP-K4s

Long L-type operation key--with cushion



### ZJP-K5

Horizontally adjustable key



### ZJP-K6

Horizontally / Vertically adjustable key



### ZJP-K8

Multi-function operating key



Light curtain

Safety door switch

Encoder

Naming rules



Official website

Safety and Control

Light curtain

Safety door switch

Encoder

Naming rules



Official website

# Encoder

## Incremental encoder naming rule

**EN** **I** **38** **KB6** **-** **3** **N** **1024** **J** **D** **-** **T** **□**  
 ① ② ③ ④ ⑤ ⑥ ⑦ ⑧ ⑨ ⑩ ⑪

### 1. Classification code

EN: Encoder

### 2. Product Type

I: Incremental

### 3. Outer diameter

38: 38mm  
50: 50mm  
58: 58mm

### 4. Shaft diameter type

KB6: Blind hole shaft-shaft diameter-6mm  
KQ6: Through shaft-shaft diameter-6mm  
KB8: Blind hole shaft-shaft diameter-8mm  
KBQ18: Shaft front clamping, shaft diameter 18mm  
KB18: Shaft rear clamping, shaft diameter 18mm  
KBQ20: Shaft front clamping, shaft diameter 20mm  
KB20: Shaft rear clamping, shaft diameter 20mm  
S6: Solid shaft diameter-6mm  
S8: Solid shaft diameter-8mm  
S10: Solid shaft diameter-10mm

### 5. Output phase

3: A, B, Z  
6: A, A-, B, B-, Z, Z-

### 6. Electrical interface

C: TTL (5V DC, 26LS31)  
E: HTL (8 DC...30V)  
N: Open collector (NPN), Z phase signal low Level valid  
NH: Open collector (NPN), Z phase signal high Level valid

### 7. Resolution (PPR)

1000: 1000 PPR  
1024: 1024 PPR  
2000: 2000 PPR  
2048: 2048 PPR  
2500: 2500 PPR  
4096: 4096 PPR  
16384: 16384 PPR  
23040: 23040 PPR  
32000: 32000 PPR  
32768: 32768 PPR  
48000: 48000 PPR  
57600: 57600 PPR  
64425: 64425 PPR

### 8. Power supply

J: 5V DC  
H: 8...30V DC

### 9. Protection level

Blank: IP50  
D: IP65

### 10. Connection method

T: Radial 1m cable  
T2: Radial 2m cable  
T5: Radial 5m cable

### 11. Special requirements

4 digits or letters

Light curtain

Safety door switch

Encoder



**Absolute encoder naming rules**

**EN** **A** **39** **S6** - **R** **B** **1716** **J** **D** - **T**   
 ① ② ③ ④ ⑤ ⑥ ⑦ ⑧ ⑨ ⑩ ⑪

**1. Classification code**

EN: Encoder

**2. Product Type**

A: Incremental

**3. Outer diameter**

39: 39mm

58: 58mm

**4. Shaft diameter type**

S6: Solid shaft diameter -6mm

S8: Solid shaft diameter -8mm

**5. Electrical interface**

R: RS-485

**6. Communication format**

B: BISS-C (binary)

S: SSI (binary)

**7. Resolution**

17: Single-turn 17-bit

1716: Single-turn 17-bit +

Multi-turn 16-bit

**8. Power supply**

J: 5V DC

H: 8...30V DC

**9. Protection level**

Blank: IP50

D: IP65

**10. Connection method**

T: Radial 1m cable

T2: Radial 2m cable

T5: Radial 5m cable

**11. Special requirements**

4 digits or letters

Light curtain

Safety door switch

Encoder





# Incremental Encoder



For specifications, certification, usage and model list, please scan the product QR code.



## Product features

- Optical principle, fast response
- Multiple outer diameter optional
- More engraved lines, higher resolution

## Application

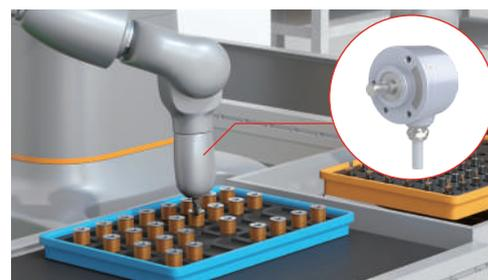

## Model specification



Model	ENI38K series	ENI38S series	ENI50S series	ENI58K series	ENI58S series
Shaft diameter	φ6mm; φ8mm	φ6mm; φ8mm	φ8mm	φ6mm; φ12mm; φ8mm	φ8mm; φ10mm
Maximum allowable speed	≤6000 rpm (IP50) ≤4000 rpm (IP65)	≤6000 rpm (IP50) ≤4000 rpm (IP65)	≤6000 rpm (IP50) ≤4000 rpm (IP65)	≤3000 rpm	≤6000rpm
Allowable shaft force	Axial 30N; Radial 20N	Axial 30N; Radial 20N	Axial 40N; Radial 20N	Axial 50N; Radial 30N	Axial 60N; Radial 40N
Moment of inertia	Below $6.5 \times 10^{-6} \text{kg} \cdot \text{m}^2 \text{s}$	Below $1.5 \times 10^{-6} \text{kg} \cdot \text{m}^2$	Below $3 \times 10^{-6} \text{kg} \cdot \text{m}^2$	Below $6.5 \times 10^{-6} \text{kg} \cdot \text{m}^2$	Below $35 \times 10^{-6} \text{kg} \cdot \text{m}^2$
Starting torque	Below $9.8 \times 10^{-3} \text{N} \cdot \text{m}$	Below $4.4 \times 10^{-3} \text{N} \cdot \text{m}$	Below $5 \times 10^{-3} \text{N} \cdot \text{m}$	Below $9.8 \times 10^{-3} \text{N} \cdot \text{m}$	At +20°C IP50 < $0.05 \text{N} \cdot \text{m}$ IP65 < $0.1 \text{N} \cdot \text{m}$
Supply voltage	5V DC ±5%; 8...30V DC ±5%				
Maximum response frequency	100KHz / 300KHz / 500KHz				

Light curtain

Safety door switch

Encoder

Naming rules



Official website



For specifications, certification, usage and model list, please scan the product QR code.



### Product features

- Small and solid structure, high rigidity, high response, high positioning accuracy

### Application



Light curtain

Safety door switch

Encoder

### Model specification

Appearance		
Model	ENA39S series	ENA58S series
Accuracy	±80"	±80"
Mechanical connection	Axial flange or slot fixing	Clamping flange
Moment of inertia	Below $6.5 \times 10^{-6} \text{ kg} \cdot \text{m}^2$	Below $3 \times 10^{-6} \text{ kg} \cdot \text{m}^2$
Allowable shaft force	Axial 30N; Radial 20N	Axial 60N; Radial 40N
Starting torque	Below $9.8 \times 10^{-3} \text{ N} \cdot \text{m}$	At +20°C IP50 <math>0.05 \text{ N} \cdot \text{m}</math> IP65 <math>0.1 \text{ N} \cdot \text{m}</math>
Communication Format	BISS-C (binary) /SSI (binary)	
Resolution	Single turn 17 Bit, multi-turn 16 Bit (single turn 17 Bit + multi-turn 16 Bit)	
Shaft diameter	φ8mm; φ10mm	
Maximum speed	≤6000 rpm	
Power supply	5V DC ±5%; 8...30V DC ±5%	

Naming rules



Official website

# 06

## Industrial Network Module and Connection System

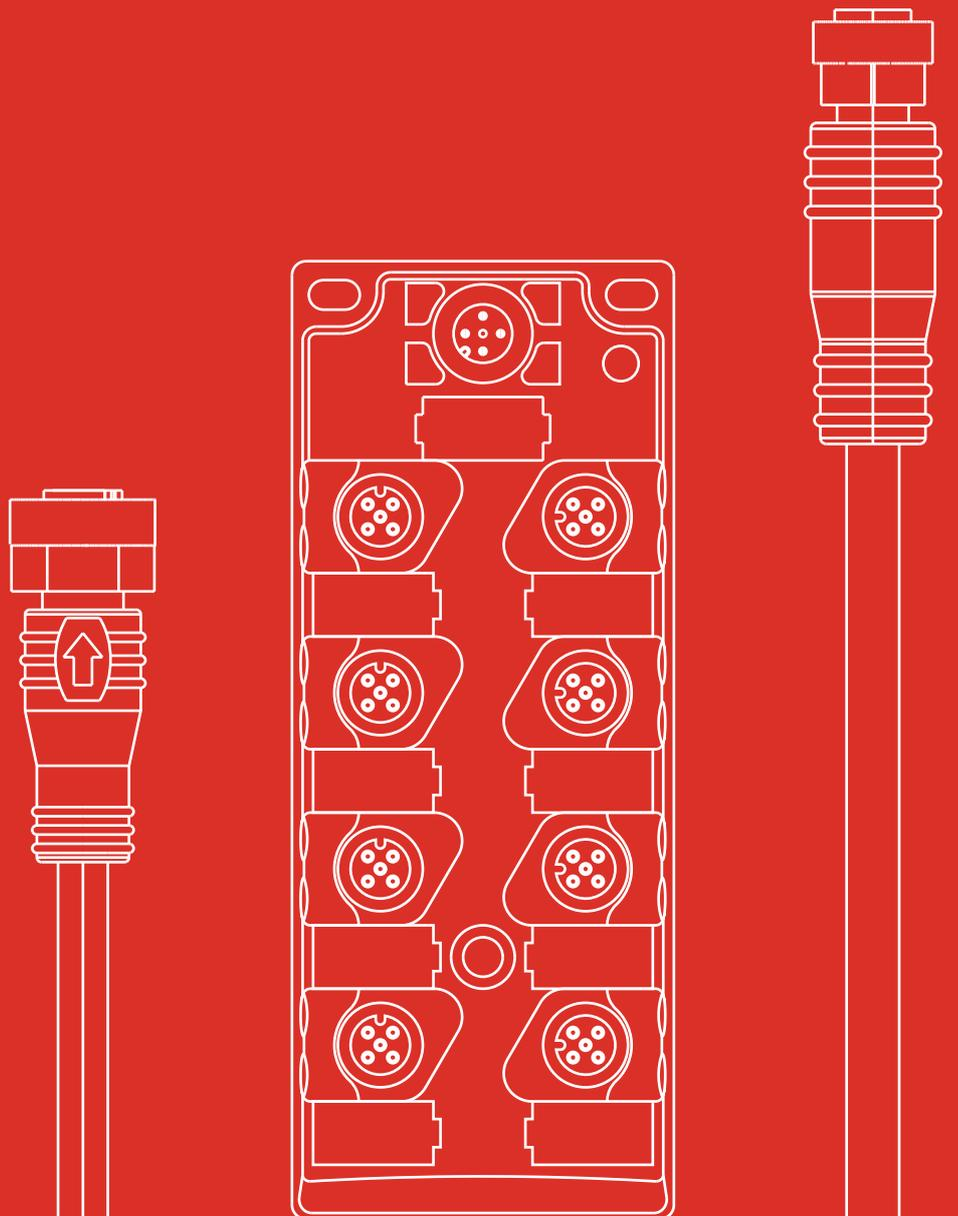

# Product Family

---

## Industrial network module

Stable and reliable communication transmission, robust metal casing, excellent cost-performance ratio, aiding in the realization of Industry 4.0.

**F01-003** Master/hub



## Junction box

Consolidate multiple power and data signals, reducing the amount of wiring needed.

**F02-001** DB08/DB12



## Connection cable

Designed to connect various electronic devices for data transmission and power supply.

**F03-001** QE8/QE12



## Standard function cylindrical series

For circuit connections, making the design and production process more convenient and flexible

**F04-001** QE8/QE12



## Industrial Network Module

## Industrial Network Module

## Master naming rules

MS ECT - S M □□ - □□□□ A  
 ① ② ③ ④ ⑤ ⑥ ⑦

**1. Product series**

MS: IO-Link master

**2. Protocol Type**

CIB: CC-Link IE Field Basic

EIP: EtherNet/IP

ECT: EtherCAT

PNT: Profinet

**3. Series code**

4 digits or letters

e.g. S: Standard specifications

**4. Shell material**

M: Plastic

S: Metal

**5. Port size**

8: M8\*1

12: M12\*1

**6. Number of I/O channels**

4 digit

0004: 4 IO-Link/8 IO

0008: 8 IO-Link/16 IO

...

**7. Product version**

4 digits or letters

e.g. A: Standard version

## Hub naming rules

HIO L - S 12 - P 1600 A  
 ① ② ③ ④ ⑤ ⑥ ⑦

**1. Product series**

HIO: IO-Link hub

**2. Series code**

In 1-digit letter

**3. Shell and connection**

S: Plastic shell with thread connection

**4. Port size**

8: M8\*1

12: M12\*1

**5. Output type**

N: NPN

P: PNP

**6. I/O Channels**

0800: 8 inputs

0008: 8 outputs

1600: 16 inputs

0016: 16 outputs

0808: 8 inputs 8 outputs

08U: 8 configurable

16U: 16 configurable

**7. Product version**

4 digits or letters

IO-Link

Junction box

Connection cable

Connector

Naming rules



Official Website

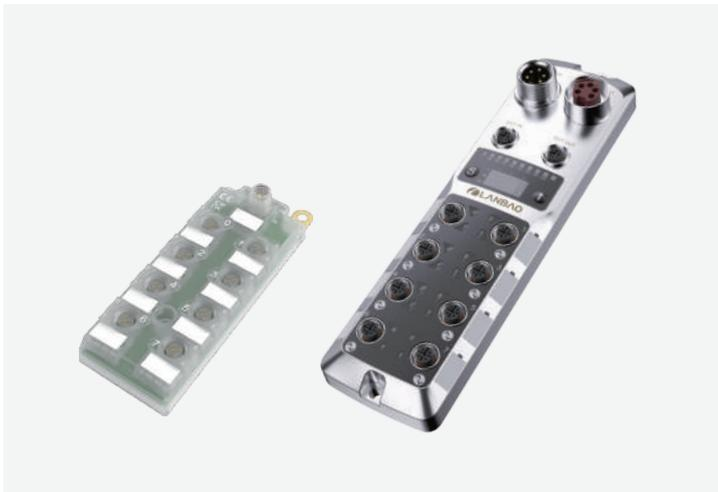

For specifications, certification, usage and model list, please scan the product QR code.



### Product features

#### IO-Link Master

- Actuator power supply 8A, sensor power supply 8A
- Single channel can connect to 2A actuator
- Output port has overload and short circuit protection
- Support digital display and button operation

#### IO-Link Hub

- Temperature range -25~70°C
- Load current 2A
- Single port supports input/output configuration
- Channel and power output support short circuit protection

### Application



Conveyor Belt Metal Parts Inspection

IO-Link

Junction box

Connection cable

Connector

### Model specification

Model	MS ECT-SM12-0008-A	HIOL-S12-P16UA	HIOL-S12-P0808A	HIOL-S12-P1600A
Power supply	18...30V DC	18...30V DC	18...30V DC	18...30V DC
Dimension	230*64.1*20mm	136.4*58.4*31*mm	136.4*58.4*31*mm	136.4*58.4*31*mm
Port	Network Interface: EtherCAT Auxiliary interface: 8*IO LINK	/	/	/
Digit input/output	Input:16*PNP,3 type Output:16*PNP	16*PNP, input or output configurable	8*PNP input+8*PNP Output	16*PNP input
Transfer rate	/	COM2 (38.4 k Baud)		
Total current	8A	2A		

Naming rules



Official Website

# Junction Box

**DB** **12** **08** **04** - **□** - **M□□** **P**  
 ① ② ③ ④ ⑤ ⑥ ⑦

## 1. Product series

DB: Junction box

## 2. Port type

M8: Connector

M12: Connector

## 3. Number of I/O channels

04: 4

08: 8

06: 6

10: 10

## 4. Hole quantity

03: 3

04: 4

05: 5

## 5. Cable material

0: Without cable

1: PVC

2: PUR

## 6. Cable specifications

None: Direct cable

D: D-SUB terminal

M: M23 terminal

03: 3m cable

05: 5m cable

07: 7m cable

## 7. LED Indication

N: NPN

P: PNP

## Quick selection

Junction box	Port type	I/O channels	I/O pins	Cable material	Cable specification	Output
DB08	M8	4/6/8/10	3/4	N/A/PVC/PUR	D/M/3/5	PNP/NPN
DB12	M12	4/6/8/10	3/4/5			

IO-Link

Junction box

Connection cable

Connector

Naming rules



Official Website



For specifications, certification, usage, and model list, please scan the product QR code.



### Product features

- Optional PNP, NPN output mode
- LED indication function
- IP67 protection level
- Standard M8/12 port connection, cable material and length optional

### Application



Assembly line metal component inspection

### Model specification

Model	Connection	Rated current	Contact impedance	Temperature range	Operation voltage	Output function
DB080403	M8 3-pin	2A/Port, 8A/Total	<8mΩ	-20...80°C	10...30V DC	NPN/PNP
DB080803		4A/Port, 10A/Total				
DB080803-D		4A/Port, 10A/Total				
DB120804	M12 4-pin	2A/Port, 8A/Total				
DB120804-M		2A/Port, 8A/Total				
DB120805	M12 5-pin	4A/Port, 10A/Total				
DB120805-M		4A/Port, 10A/Total				

IO-Link

Junction box

Connection cable

Connector

Naming rules



Official Website



## Connection System

## Connection Cable

QE12 - N3 G 5 - P - U - □□□□

①                      ②                      ③                      ④                      ⑤                      ⑥                      ⑦

**1.Connector type**

QE8: M8  
QE12: M12

**2.Thread form and pins**

N3: 3-pins female  
N4: 4-pins female  
W3: 3-pins male  
W4: 4-pins male

**3.Cable direction**

F: 180° Straight angle  
G: 90° Right angle

**4.Cable length**

2: 2m cable  
5: 5m cable  
10: 10m cable

**5.Output**

Blank: No LED, for NPN/PNP  
N: With LED, NPN  
P: With LED, for PNP

**6.Cable material**

Blank: PVC  
U: PUR

**7.Special requirement**

4 digits or letters

IO-Link

Junction box

Connection  
cable

Connector

## Quick selection

Series	Thread form	Cable wires	Cable direction	Output (-P/N)	Cable material (-U/R)	Cable length (m)
QE8	Female/male	3/4 wires	Right angle, Straight angle	NPN/PNP	PVC/PUR	2/5/10
QE12		3/4/5 wires				

Naming rules



Official Website



For specifications, certification, usage, and model list, please scan the product QR code.



### Product features

- Built-in sealing pattern, IP67
- High-brightness LED type, working status is clearly visible
- With vibration protection function to prevent nut loosening
- Standard M8/12 connection, cable material and length optional

### Application

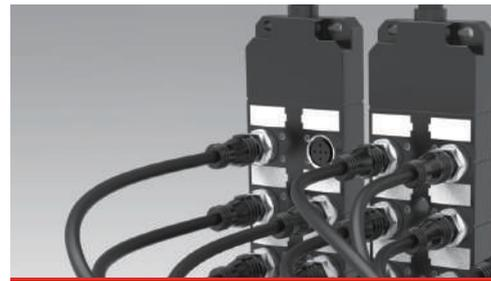

Assembly line metal component inspection

### Model specification

#### Universal type

Model	Cable material	Cable specification	I/O pins	Temperature range	Rated current	Insulation resistance
QE8-N3Fx	PVC	3*0.25mm <sup>2</sup>	3	-30...90°C	4A	100MΩ
QE8-N3Fx-R	Flexible drag chain cable					
QE8-N3Fx-U	PUR					
QE8-W3Gx	PVC					
QE8-W3Gx-R	Flexible drag chain cable					
QE8-W3Gx-U	PUR					
QE12-N4Fx	PVC	4*0.34mm <sup>2</sup>	4	-30...90°C	4A	100MΩ
QE12-N4Fx-R	Flexible drag chain cable					
QE12-N4Fx-U	PUR					
QE12-W4Gx	PVC					
QE12-W4Gx-R	Flexible drag chain cable					
QE12-W4Gx-U	PUR					

IO-Link

Junction box

Connection cable

Connector

Naming rules



Official Website

## With LED

Model	Output	Cable material	Cable specification	I/O pins	Temperature range	Rated current	Insulation resistance
QE8-N3Fx-P	With LED PNP	PVC	3*0.25mm <sup>2</sup>	3	-30...90°C	4A	100MΩ
QE8-N3Fx-N	With LED NPN	PVC					
QE8-N3Fx-N-U	With LED NPN	PUR					
QE8-N3Fx-P-R	With LED PNP	Flexible drag chain cable					
QE8-W3Gx-P	With LED PNP	PVC					
QE8-W3Gx-N	With LED NPN	PVC					
QE8-W3Gx-P-R	With LED PNP	Flexible drag chain cable					
QE8-W3Gx-P-R	With LED PNP	Flexible drag chain cable					
QE12-N4Fx-P	With LED PNP	PVC	4*0.34mm <sup>2</sup>	4			
QE12-N4Fx-P	With LED PNP	PVC					
QE12-N4Fx-N-R	With LED NPN	Flexible drag chain cable					
QE12-N4Fx-N-U	With LED NPN	PUR					
QE12-W4Gx-P	With LED PNP	PVC					
QE12-W4Gx-P	With LED PNP	PVC					
QE12-W4Gx-N-R	With LED NPN	Flexible drag chain cable					
QE12-W4Gx-N-R	With LED NPN	Flexible drag chain cable					

IO-Link

Junction box

Connection cable

Connector

Naming rules



Official Website

Connection System

IO-Link

Junction box

Connection cable

Connector

Naming rules



## Connection System

## Connector

**QE12** - **N3** **G**  
 ①                      ②                      ③

**1.Connector type**

QE8: M8  
 QE12: M12

**2.Thread form and pins**

N3: 3-pins female  
 N4: 4-pins female  
 W3: 3-pins male  
 W4: 4-pins male

**3.Cable direction**

F: 180° Straight angle  
 G: 90° Right angle

IO-Link

Junction box

Connection cable

Connector

**Quick selection**

Series	Pins	Connector			
		Female straight angle	Female right angle	Male straight angle	Male right angle
QE8	3 wires	QE8-N3F	/	QE8-W3F	/
	4 wires	QE8-N4F	/	QE8-W4F	/
QE12	4 wires	QE12-N4F	QE12-N4G	QE12-W4F	QE12-W4G
	5 wires	QE12-N5F	QE12-N5G	QE12-W5F	QE12-W5G

Naming rules



Official Website



For specifications, certification, usage, and model list, please scan the product QR code.



### Product features

- Built-in terminal
- Standard M8/12 connection
- IP67 protection
- Vibration protection function to prevent nut loosening

### Application

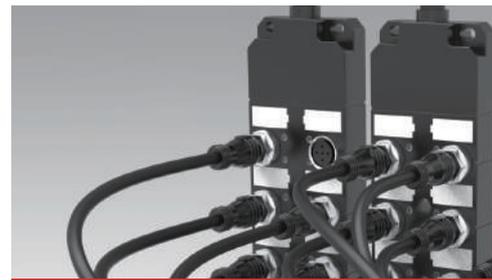

IO-Link

Junction box

Connection cable

Connector

### Model specification

Model	I/O pins	Operation voltage	Matching cable diameter	Temperature range	Rated current	Insulation resistance
QE8-N3F	3	60V AC/DC	4...5mm	-40...85°C	4A	100MΩ
QE8-N4F	4					
QE8-W3F	3					
QE8-W4F	4					
QE12-N4F	4	250V AC/DC	4...6mm			
QE12-N5F	5					
QE12-N4G	4					
QE12-N5G	5					

Naming rules



Official Website

# 07

## Sensor Accessories

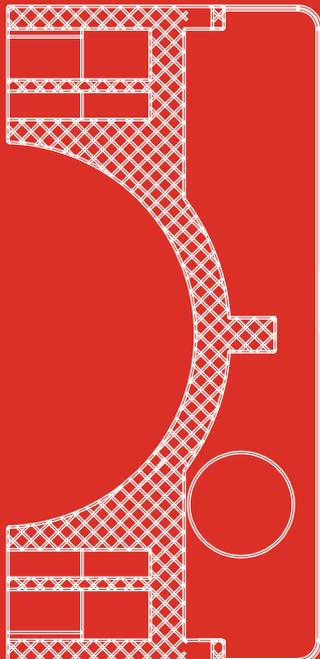

# Reflectors

## Reflector

TD-01

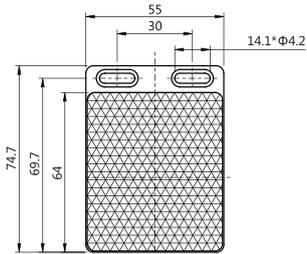

TD-01-3

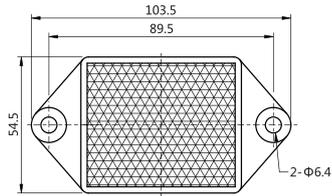

TD-02

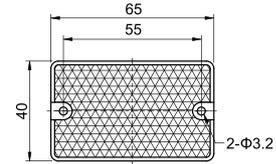

TD-03

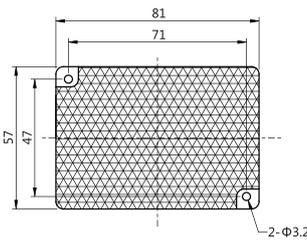

TD-04

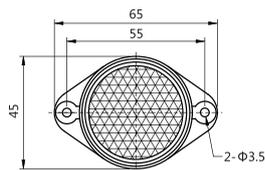

TD-05

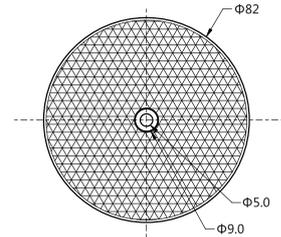

Match series: PTL

STD-06

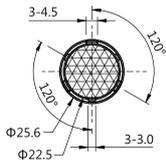

TD-08

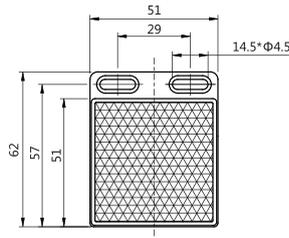

TD-09

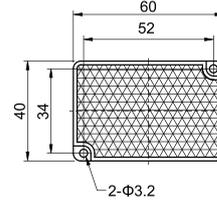

Match series: PR18, PR18S, PR30, PTE, PSE, PSS, PSM

TD-09A

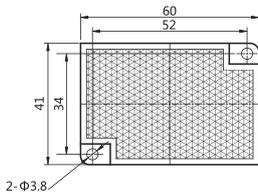

TD-10

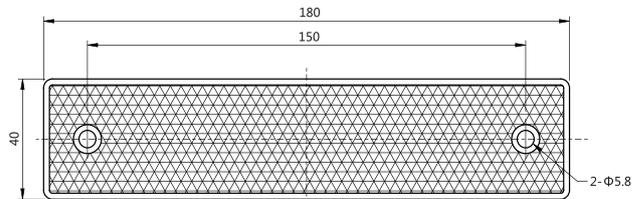

TD-11

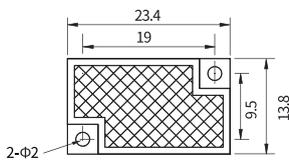

TD-12

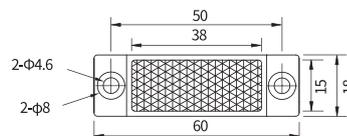



# Mounting Brackets For Capacitive Sensors

## ZJC-1 (CQ20/CQ20S Mounting brackets)

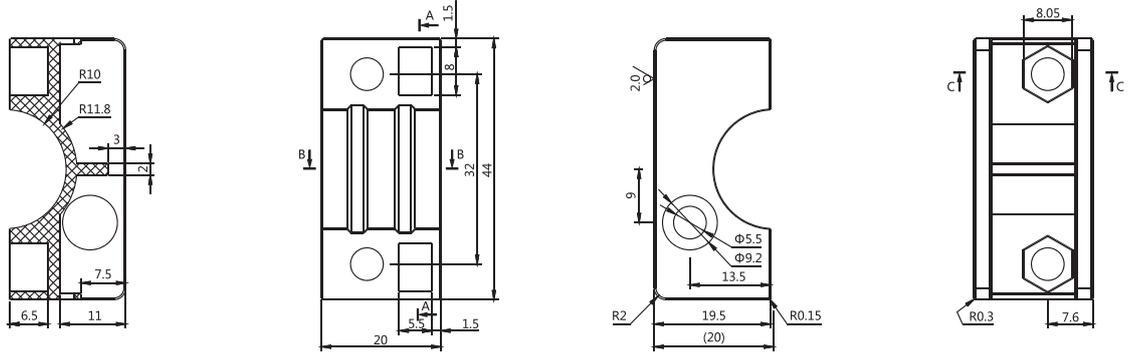

## ZJC-2 (CQ32/CQ32S Mounting brackets)

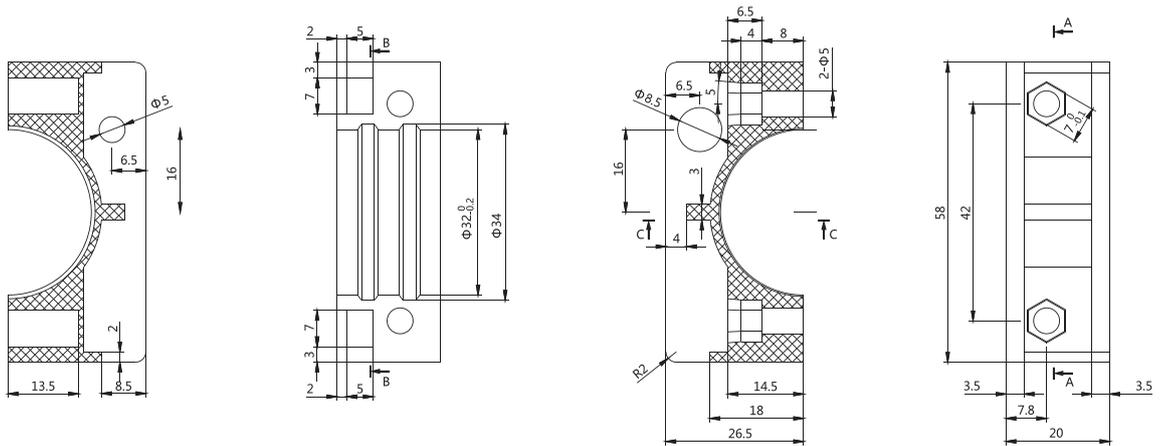

## ZJC-3 (CQ34S Mounting brackets)

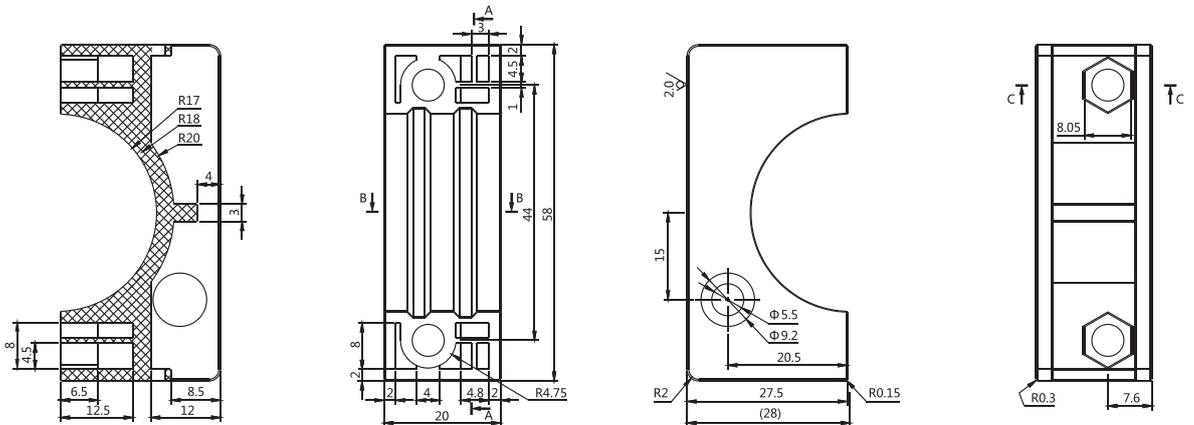

# Mounting Brackets For Photoelectric sensors

## ZJP-1

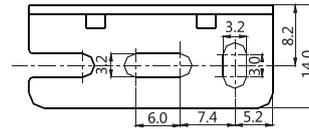
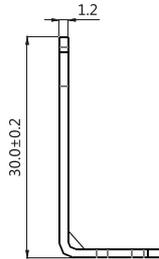
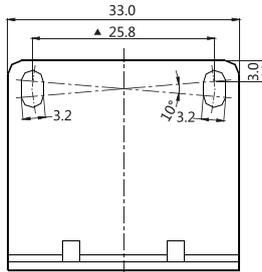

## ZJP-5 (PTF/PTE Mounting brackets)

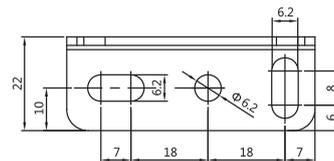
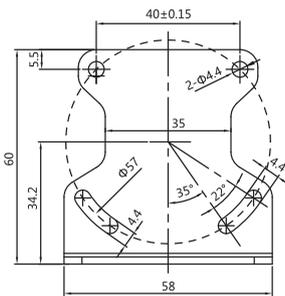

## ZJP-6 (PTL Mounting brackets)

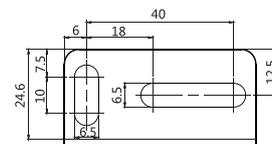
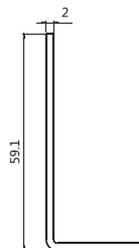
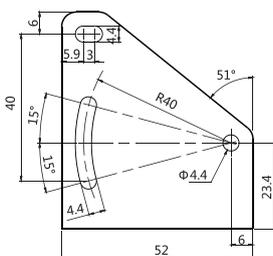

## ZJP-7 (PTB Mounting brackets)

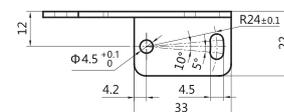
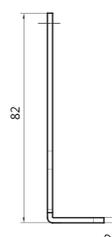
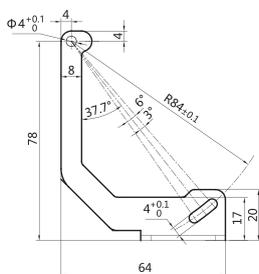

## ZJP-8 (PSE/PSR Mounting brackets)

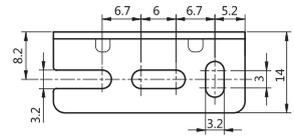
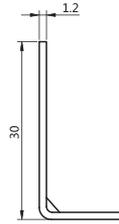
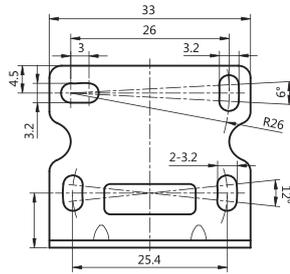

## ZJP-9 (PSS/PSM Mounting brackets)

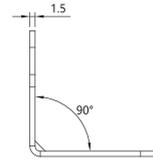
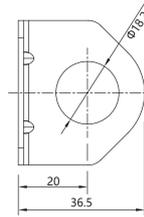
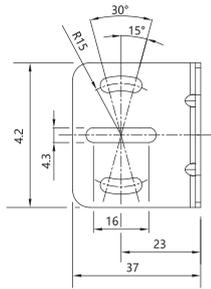

## ZJP-10 (PSS Mounting brackets)

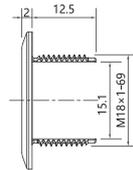
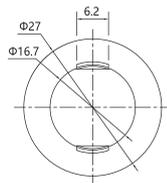

## ZJP-11 (PST Mounting brackets)

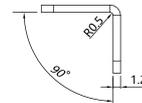
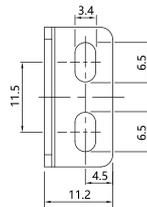
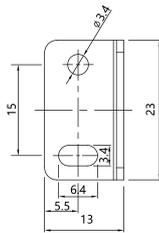

## ZJP-12 (PST Mounting brackets)

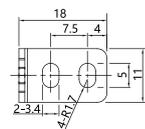
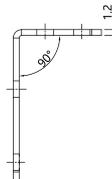
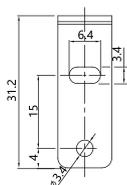



# SERVICE AND SUPPORT

---





## Excellent service

- One-to-one service, first time response.
- Personalized selection service, ultimate VIP experience.

We are looking forward to your call!

**0086-21-57486188-8806**

## Remarkable quality

Comprehensive quality control from raw materials supply to service.

- Product quality verification of 8 major laboratories.
- Safe production, precise management, and high-quality performance.
- Dynamic system, excellent service, and comprehensive quality control.



## Personalized selection service

- Website+Catalog for selection, Lanbao professional team offers more efficient online selection services, providing professional customized solutions for different situations.

**Lanbao websites:**

[www.lanbaosensor.com](http://www.lanbaosensor.com)/[www.cnlanbaosensor.com](http://www.cnlanbaosensor.com)

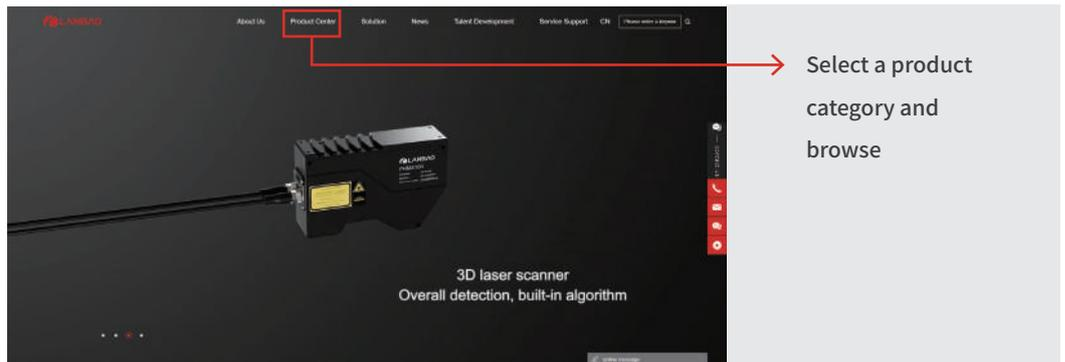

## Full life cycle service

- Lanbao's technical team provides customers with complete services from product selection/personalized customization, sales, system integration, training, operation, customized solutions. Lanbao provides customers with efficient customized services and quality assurance. Standard orders and regular stock products can be shipped immediately. Maintenance, after-sales and upgrade.

## Customized solutions

- Lanbao provides customers with efficient customized services and quality assurance.
- Standard orders and regular stock products can be shipped immediately.



## Quality system with efficiency management

- The reliable and stable manufacturing management system makes Lanbao intelligent production come true. Each product of Lanbao not only strictly implements feasibility and reliability review in the design stage but also has strict control by quality statistical management in the production process. In this way, product's great performance and ability to withstand harsh environment can be ensured. With the ultimate spirit of ingenuity, Lanbao guarantees the best quality of products to satisfy customer's needs.

# GLOBAL FOOTPRINTS

---

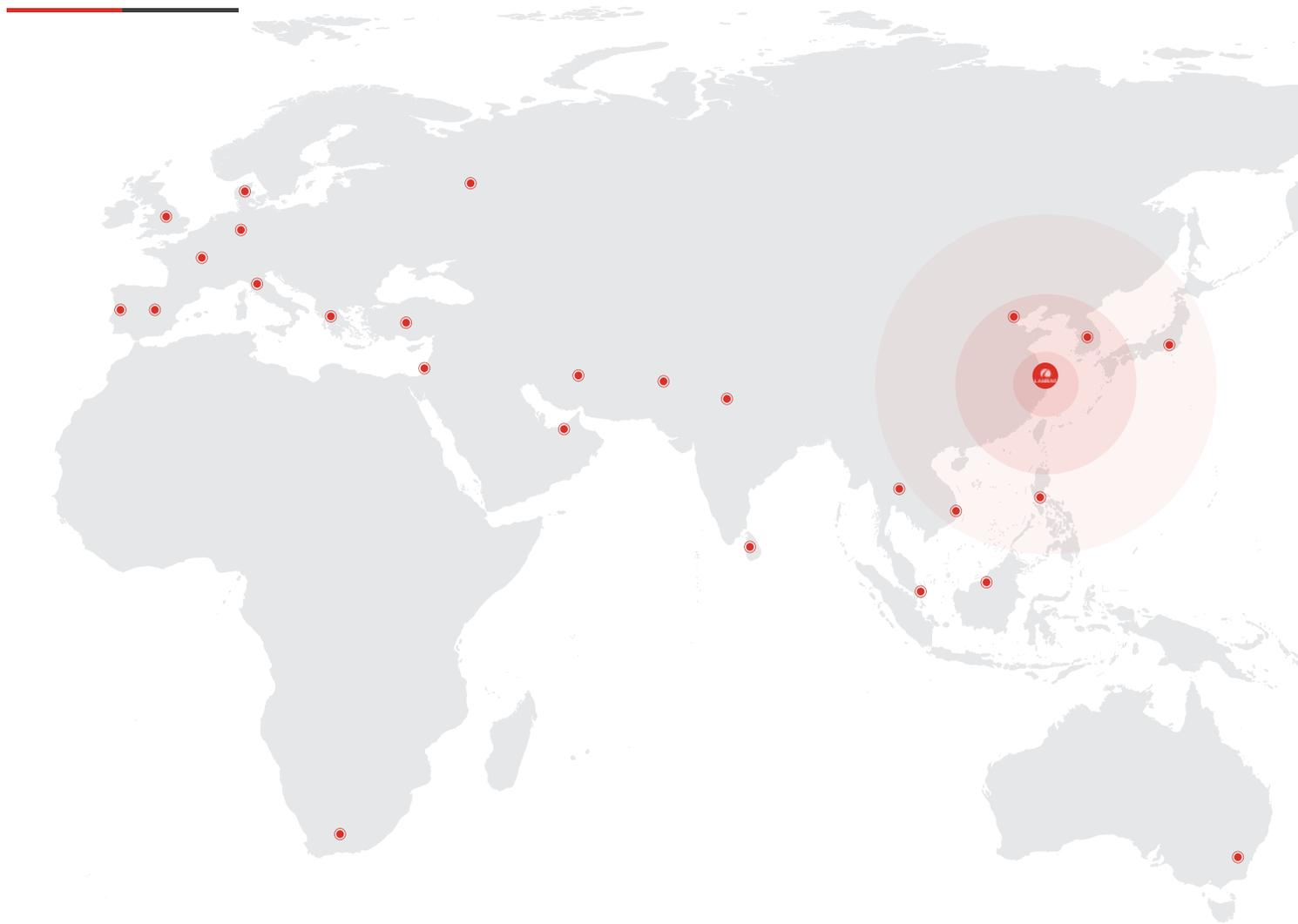

Lanbao' s safe and reliable sensors are sold to more than 120 countries and regions and received unanimous praise and favor from global customers.

**120<sup>+</sup>**  
Countries and regions

**30000<sup>+</sup>**  
Global users

# Sensing the dream

